



# HÄLT EWIG LASTS FOREVER



2023



CHROM-VANADIUM

24

## **HEYTEC TOOLS AUS DEM HAUSE HEYCO**

In der über 80-jährigen Unternehmensgeschichte haben wir uns zu einem der führenden Werkzeughersteller entwickelt. Angetrieben von der Leidenschaft, unseren Kunden Produkte anzubieten, die gekennzeichnet sind durch ein Höchstmaß an Qualität und Gebrauchsnutzen.

Mit unserer Marke HEYTEC TOOLS sprechen wir den qualitäts- und preisbewussten Handwerker ebenso an wie den anspruchsvollen Heimwerker. Mit einem umfassenden, maßgeschneiderten Werkzeugprogramm, ausgerichtet auf die jeweiligen Bedürfnisse des Anwenders.

## **HEYTEC TOOLS MANUFACTURED BY HEYCO**

In our company's more than 80-year history, we have developed to become one of the leading tool manufacturers. Driven by the passion for offering our customers products that are distinguished by exceptional quality and usability. Our HEYTEC TOOLS brand addresses both quality and price conscious professional craftsmen and discerning DIY enthusiasts with a comprehensive portfolio of tailor-made tools aligned to the specific needs of their users.



**BESTE QUALITÄT ZUM BESTEN PREIS**  
**BEST QUALITY AT THE BEST PRICE**

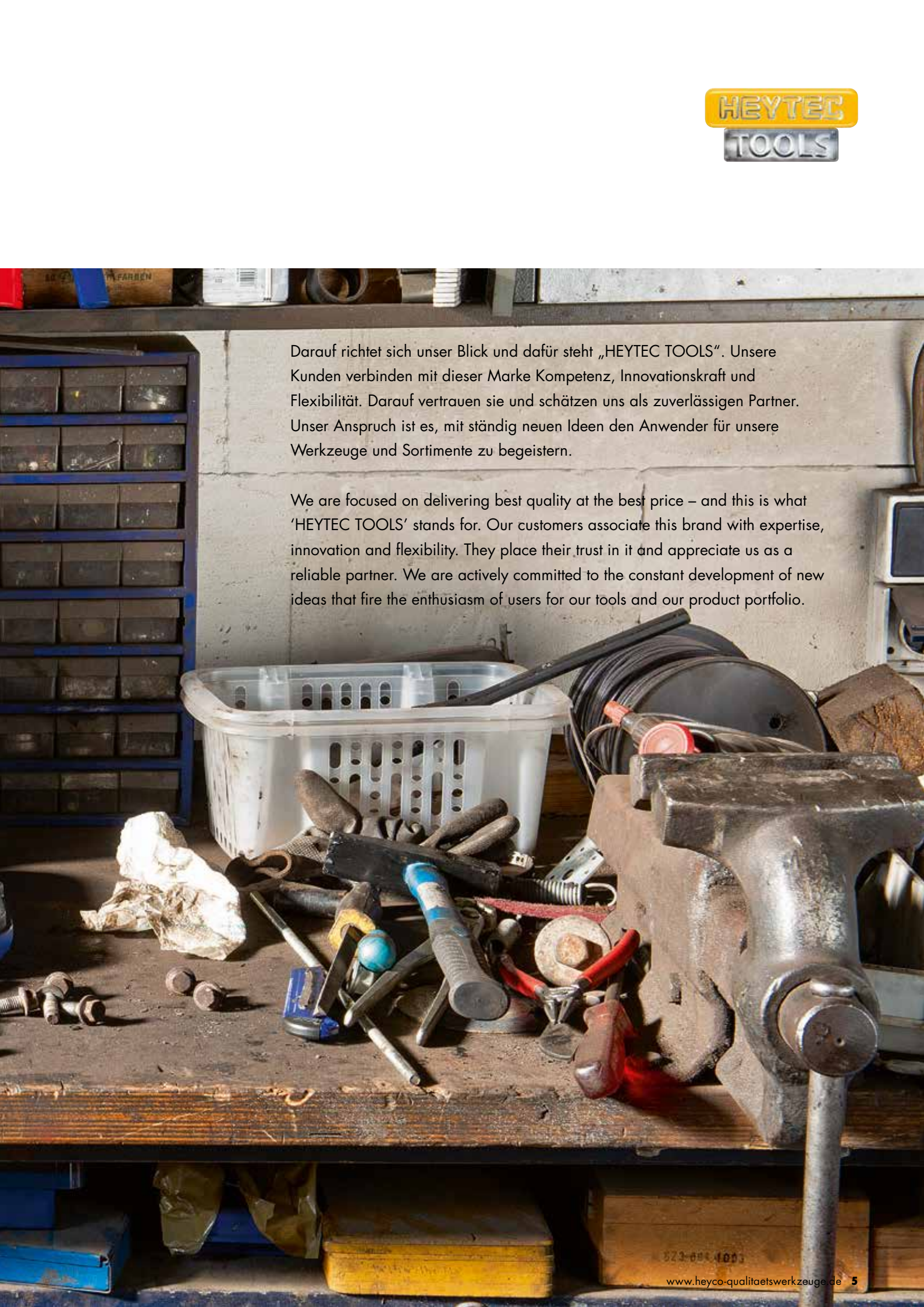

A photograph of a cluttered workbench in a workshop. In the foreground, a large metal vise is mounted on a wooden workbench. Various tools are scattered around, including a hammer, pliers, and a screwdriver. A white plastic basket is in the background, and a blue metal cabinet with many small drawers is visible on the left. The background wall is concrete.

Darauf richtet sich unser Blick und dafür steht „HEYTEC TOOLS“. Unsere Kunden verbinden mit dieser Marke Kompetenz, Innovationskraft und Flexibilität. Darauf vertrauen sie und schätzen uns als zuverlässigen Partner. Unser Anspruch ist es, mit ständig neuen Ideen den Anwender für unsere Werkzeuge und Sortimente zu begeistern.

We are focused on delivering best quality at the best price – and this is what ‘HEYTEC TOOLS’ stands for. Our customers associate this brand with expertise, innovation and flexibility. They place their trust in it and appreciate us as a reliable partner. We are actively committed to the constant development of new ideas that fire the enthusiasm of users for our tools and our product portfolio.

**WIR FERTIGEN NACH IHREN WÜNSCHEN  
CUSTOMIZED TOOLS**

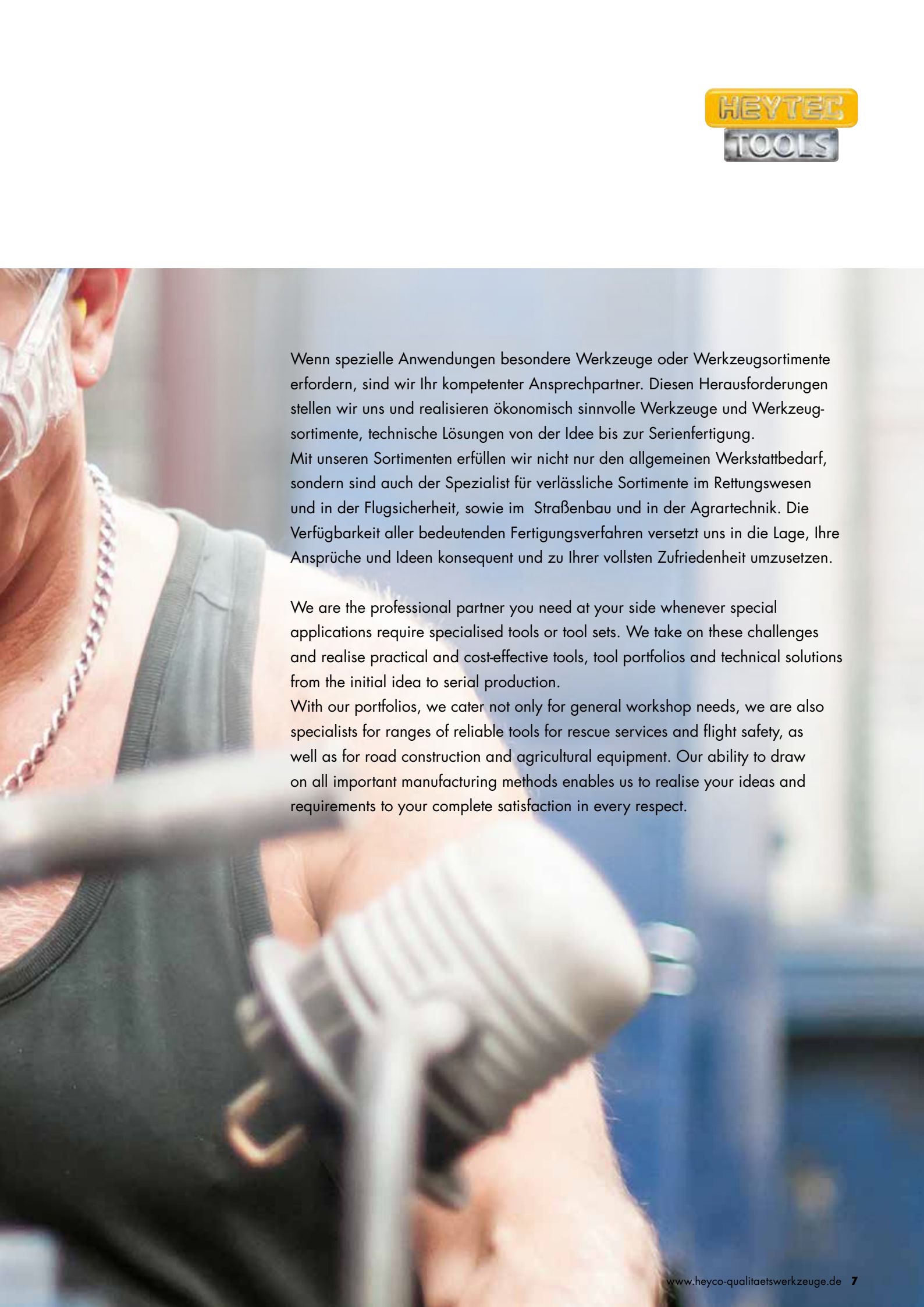

A close-up photograph of a worker wearing safety glasses and a dark tank top, using a power tool. The worker's face is partially visible on the left side of the frame, and the tool is in the foreground, slightly out of focus. The background is a blurred industrial setting.

Wenn spezielle Anwendungen besondere Werkzeuge oder Werkzeugsortimente erfordern, sind wir Ihr kompetenter Ansprechpartner. Diesen Herausforderungen stellen wir uns und realisieren ökonomisch sinnvolle Werkzeuge und Werkzeugsortimente, technische Lösungen von der Idee bis zur Serienfertigung.

Mit unseren Sortimenten erfüllen wir nicht nur den allgemeinen Werkstattbedarf, sondern sind auch der Spezialist für verlässliche Sortimente im Rettungswesen und in der Flugsicherheit, sowie im Straßenbau und in der Agrartechnik. Die Verfügbarkeit aller bedeutenden Fertigungsverfahren versetzt uns in die Lage, Ihre Ansprüche und Ideen konsequent und zu Ihrer vollsten Zufriedenheit umzusetzen.

We are the professional partner you need at your side whenever special applications require specialised tools or tool sets. We take on these challenges and realise practical and cost-effective tools, tool portfolios and technical solutions from the initial idea to serial production.

With our portfolios, we cater not only for general workshop needs, we are also specialists for ranges of reliable tools for rescue services and flight safety, as well as for road construction and agricultural equipment. Our ability to draw on all important manufacturing methods enables us to realise your ideas and requirements to your complete satisfaction in every respect.

**NEW** 



	35 Satz mit Steckschlüsseinsätzen Socket set



	100 Drehmomentschlüssel, verstellbar mit Einhand-Spannzange Adjustable torque wrench with one-hand clamp

	116 Arbeitslampe Working lamp



	112 Montagezangen-Satz, 4-tlg. Circlip plier set, 4 pcs.



**NEW** 



**137** Aluminium Maßstab  
Aluminium scale



**151** Gummiaufsatz für Fäustel  
Rubber attachment for club hammer

Pflasterhammer  
Pavement hammer



**155** Dreikant-Steckschlüssel, M5  
Tubular triangular wrench, M5



**156** Hebel- und Montageeisen  
Pry bar



**174** Rohrsteckschlüssel, extra lang  
Double ended tubular socket wrenches, extra long

Rohrsteckschlüssel-Satz  
Double ended tubular socket wrench set



**181** Dämmstoffmesser  
Knife for insulating material



**182** Bauhandsäge  
Construction hand saw

12 – 25

---

26 – 67

---

68 – 85

---

86 – 103

---

104 – 117

---

118 – 133

---

134 – 157

---

158 – 175

---

176 – 187

---

188 – 199



28 - 41

1/4"



42 - 45

3/8"



46 - 63

1/2"



64 - 67

3/4"

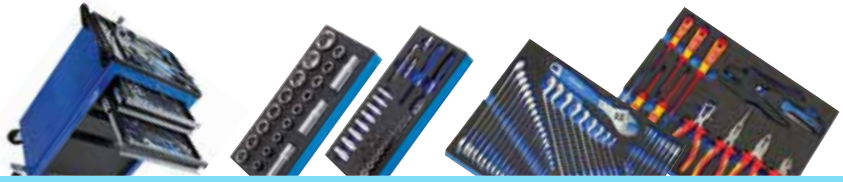

Index | Art.-No. | EAN-No.





## 50800

DIN 3110 / ISO 1085



### Doppelmaulschlüssel

Chrom-Vanadium, verchromt

Double ended

open jaw wrenches

Chrome-Vanadium, chromium plated

Steeksleutel

Chroom-Vanadium, verchromd

Clés à fourche

Chrome-Vanadium, chromées

Llaves fijas de dos bocas

abiertas

Cromo Vanadio, cromadas

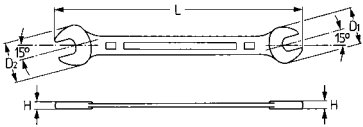

Bestell-No./Order-No.	MM	Cl mm	H mm	D1 mm	D2 mm	g		€
<b>50800060780</b>	6 x 7	122	3,6	15,7	17,7	18	10	<b>2,65</b>
<b>50800080980</b>	8 x 9	140	3,9	20,8	22,9	32	10	<b>2,75</b>
<b>50800081080</b>	8 x 10	140	3,9	20,8	22,9	32	10	<b>2,95</b>
<b>50800101180</b>	10 x 11	156	4,8	23,9	26,9	54	10	<b>2,95</b>
<b>50800101380</b>	10 x 13	172	5,3	28,0	31,0	67	10	<b>3,10</b>
<b>50800111380</b>	11 x 13	172	5,5	28,0	29,8	75	10	<b>3,30</b>
<b>50800121380</b>	12 x 13	172	5,3	28,0	31,0	61	10	<b>3,30</b>
<b>50800131580</b>	13 x 15	190	5,7	32,5	34,9	89	10	<b>4,00</b>
<b>50800131780</b>	13 x 17	204	5,9	32,1	38,2	110	10	<b>4,40</b>
<b>50800141580</b>	14 x 15	190	5,7	32,5	34,9	90	10	<b>4,00</b>
<b>50800161780</b>	16 x 17	204	5,9	36,1	39,2	105	10	<b>4,40</b>
<b>50800161880</b>	16 x 18	204	5,9	36,1	39,2	115	10	<b>5,15</b>
<b>50800171980</b>	17 x 19	223	6,5	40,2	42,3	155	10	<b>5,30</b>
<b>50800181980</b>	18 x 19	223	6,5	40,2	42,3	150	10	<b>5,30</b>
<b>50800192280</b>	19 x 22	236	6,8	44,9	48,4	190	10	<b>6,90</b>
<b>50800202280</b>	20 x 22	236	6,8	44,9	48,4	185	10	<b>6,90</b>
<b>50800212380</b>	21 x 23	250	7,3	47,4	51,5	265	5	<b>7,80</b>
<b>50800242780</b>	24 x 27	265	7,8	52,5	58,6	310	5	<b>8,90</b>
<b>50800252880</b>	25 x 28	280	8,1	55,2	61,3	350	5	<b>10,90</b>
<b>50800273080</b>	27 x 30	280	8,1	58,6	64,4	355	5	<b>13,45</b>
<b>50800303280</b>	30 x 32	302	8,6	64,8	70,3	480	5	<b>14,65</b>
<b>50800323680</b>	32 x 36	325	8,8	66,5	74,5	550	5	<b>22,95</b>
<b>50800364180</b>	36 x 41	358	8,8	74,5	84,0	730	5	<b>30,05</b>
<b>50800414680</b>	41 x 46	450	10,4	84,0	92,6	1140	5	<b>40,85</b>

## K 50800 HP 50800 B 50800 R 50800

### Doppelmaulschlüssel-Sätze

Double ended open jaw wrenches sets

Steeksleutelset

Jeux de clés à fourche

Juegos de llaves fijas de dos bocas abiertas

R 50890



B 50800





HP 50800



K 50800

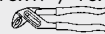

Bestell-No./Order-No.	Art. No.	MM	g		€
<b>50800021200</b>	R 50800-212	Werkzeuggrolltasche, leer / 12 Fächer / Tool wallet, empty / 12 compartments	200	5	<b>17,20</b>
<b>50800944080</b>	K 50800-8-M	6x7 / 8x9 / 10x11 / 12x13 / 14x15 / 16x17 / 18x19 / 20x22	695	1	<b>30,50</b>
<b>50800947080</b>	K 50800-12-M	6x7 / 8x9 / 10x11 / 12x13 / 14x15 / 16x17 / 18x19 / 20x22 / 21x23 / 24x27 / 25x28 / 30x32	2100	1	<b>68,60</b>
<b>50800844080</b>	B 50800-8-M	6x7 / 8x9 / 10x11 / 12x13 / 14x15 / 16x17 / 18x19 / 20x22	710	1	<b>36,05</b>
<b>50800644080</b>	HP 50800-8-M	6x7 / 8x9 / 10x11 / 12x13 / 14x15 / 16x17 / 18x19 / 20x22	790	1	<b>32,50</b>
<b>50800747080</b>	R 50800-12-M	6x7 / 8x9 / 10x11 / 12x13 / 14x15 / 16x17 / 18x19 / 20x22 / 21x23 / 24x27 / 25x28 / 30x32	2101	1	<b>76,85</b>
<b>50890300200</b>	R 50890-12-M	6x7 / 8x9 / 10x11 / 12x13 / 14x15 / 16x17 / 18x19 / 20x22 / 21x23 / 24x27  240 mm  255 mm / 10"	1990	1	<b>87,15</b>

**50810**  
DIN 3113 A / ISO 7738



**Ringmaulschlüssel**

Chrom-Vanadium, verchromt,  
Schon-Profil

Combination wrenches

Chrome-Vanadium, chromium plated,  
profile saver

Ringsteeksleutels

Chroom-Vanadium, verchromd,  
profiel beschermer

Clés mixtes

Chrome-Vanadium, chromées,  
profil de protection SP

Llaves combinadas

Cromo Vanadio, cromadas,  
perfil especial SP

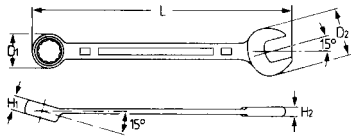

Bestell-No./Order-No.	ØMM	CL mm	H1 mm	H2 mm	D1 mm	D2 mm	g	mm	€
<b>50810006080</b>	6	100	5,0	3,9	9,8	15,7	12	10	<b>2,70</b>
<b>50810007080</b>	7	110	5,5	4,2	11,2	17,0	18	10	<b>2,70</b>
<b>50810008080</b>	8	120	5,9	4,4	12,7	19,0	23	10	<b>2,75</b>
<b>50810009080</b>	9	130	6,4	4,7	14,1	20,9	33	10	<b>2,85</b>
<b>50810010080</b>	10	140	6,9	5,0	15,5	22,8	40	10	<b>2,90</b>
<b>50810011080</b>	11	150	7,4	5,2	16,9	25,4	48	10	<b>3,00</b>
<b>50810012080</b>	12	160	7,9	5,5	18,3	26,7	58	10	<b>3,40</b>
<b>50810013080</b>	13	170	8,4	5,8	19,7	29,3	63	10	<b>3,75</b>
<b>50810014080</b>	14	180	8,9	6,1	21,1	31,2	88	10	<b>4,00</b>
<b>50810015080</b>	15	190	9,3	6,3	22,6	33,0	97	10	<b>4,15</b>
<b>50810016080</b>	16	200	9,8	6,6	24,0	34,5	105	10	<b>4,25</b>
<b>50810017080</b>	17	210	10,3	6,9	25,4	37,3	130	10	<b>4,45</b>
<b>50810018080</b>	18	220	10,8	7,1	26,8	38,4	145	10	<b>5,45</b>
<b>50810019080</b>	19	230	11,1	7,3	28,2	40,4	145	10	<b>6,70</b>
<b>50810020080</b>	20	240	11,4	7,5	29,6	42,3	165	10	<b>6,70</b>
<b>50810021080</b>	21	250	11,7	7,7	31,0	44,2	190	10	<b>7,25</b>
<b>50810022080</b>	22	260	12,0	7,9	32,3	46,6	225	10	<b>8,70</b>
<b>50810024080</b>	24	280	12,7	8,3	35,1	50,1	265	5	<b>10,65</b>
<b>50810027080</b>	27	310	13,6	8,9	39,2	55,9	330	5	<b>13,30</b>
<b>50810030080</b>	30	340	14,6	9,5	43,4	62,6	430	5	<b>15,75</b>
<b>50810032080</b>	32	360	15,2	9,9	46,2	66,9	515	5	<b>16,20</b>
<b>50810036080</b>	36	400	22,8	14,1	54,6	77,5	1090	5	<b>37,60</b>
<b>50810041080</b>	41	450	25,8	15,8	62,1	83,7	1450	3	<b>54,55</b>

**B 50810**  
**HP 50810**  
**K 50810**  
**R 50810**  
DIN 3113 A / ISO 7738

**Ringmaulschlüssel-Sätze**

Chrom-Vanadium, verchromt,  
Schon-Profil

Combination wrenches sets

Chrome-Vanadium, chromium plated,  
profile saver

Ringsteeksleutelset

Chroom-Vanadium, verchromd,  
profiel beschermer

Jeux de clés mixtes

Chrome-Vanadium, chromées,  
profil de protection SP

Juegos de llaves combinadas

Cromo Vanadio, cromadas,  
perfil especial SP

R 50810

R 50810-21

B 50810

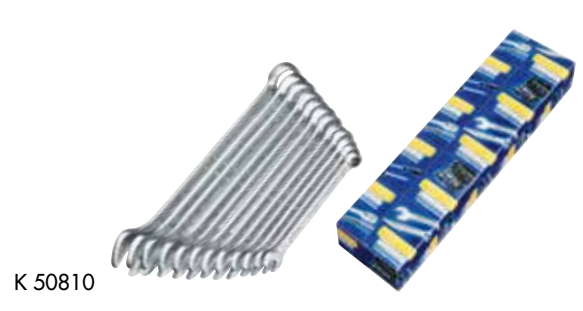

HP 50810-12

K 50810

Bestell-No./Order-No.	Art. No.	ØMM	g	mm	€
<b>50810924280</b>	K 50810-8-M	8/9/10/11/13/14/17/19	570	1	<b>26,75</b>
<b>50810927180</b>	K 50810-12-M-1	8/9/10/11/12/13/14/15/16/17/18/19	1055	1	<b>42,25</b>
<b>50810927280</b>	K 50810-12-M-2	6/7/8/9/10/11/12/13/14/17/19/22	1135	1	<b>42,25</b>
<b>50810929080</b>	K 50810-17-M	6/7/8/9/10/11/12/13/14/15/16/17/18/19/20/21/22	1575	1	<b>66,70</b>
<b>50810929480</b>	K 50810-21-M	6/7/8/9/10/11/12/13/14/15/16/17/18/19/20/21/22/24/27/30/32	4080	1	<b>113,80</b>
<b>50810824280</b>	B 50810-8-M	8/9/10/11/13/14/17/19	590	1	<b>31,75</b>
<b>50810827180</b>	B 50810-12-M	8/9/10/11/12/13/14/15/16/17/18/19	980	1	<b>50,30</b>
<b>50810724280</b>	R 50810-8-M	8/10/12/13/14/15/17/19	675	1	<b>39,10</b>
<b>50810727180</b>	R 50810-12-M-1	8/9/10/11/12/13/14/15/16/17/18/19	1055	1	<b>57,05</b>
<b>50810727280</b>	R 50810-12-M-2	6/7/8/9/10/11/12/13/14/17/19/22	1055	1	<b>57,05</b>
<b>50810729480</b>	R 50810-21-M	6/7/8/9/10/11/12/13/14/15/16/17/18/19/20/21/22/24/27/30/32	3350	1	<b>130,05</b>
<b>50810627380</b>	HP 50810-12-M	8/10/11/12/13/14/15/16/17/18/19/22	1270	1	<b>52,10</b>

## 50839-9004

### Mini-Einmaulschlüssel, verstellbar

Chrom-Vanadium, verchromt,  
mit Kunststoff-Handschutz und Skala

### Mini-Adjustable wrench

Chrome-Vanadium, chromium plated,  
with soft grip plastic handle and scale

### Mini Verstelbare moersleutel, omschakelbaar

Chroom-Vanadium, verchromd,  
met kunststof handbescherming  
en schaalverdeling

### Mini clés à molette

Chrome-Vanadium, chromées,  
avec poignée gainée et graduation

### Mini llaves ajustables

Cromo Vanadio, cromadas,  
con mango de plástico y escala



Bestell-No./Order-No.	Art. No.	mm	CL	"	MM/AF	g		€
<b>50839900480</b>	50839-9004	110		4	0 - 15 0 - 5/8"	65	1	<b>19,70</b>

## 50839

### Einmaulschlüssel, verstellbar

Chrom-Vanadium, verchromt,  
mit Kunststoff-Handschutz und Skala

### Adjustable wrenches

Chrome-Vanadium, chromium plated,  
with soft grip plastic handle and scale

### Verstelbare moersleutel

Chroom-Vanadium, verchromd,  
met kunststof handbescherming en  
schaalverdeling

### Clés à molette

Chrome-Vanadium, chromées,  
avec poignée gainée et graduation

### Llaves ajustables

Cromo Vanadio, cromadas,  
con mango de plástico y escala



Bestell-No./Order-No.	Art. No.	mm	CL	"	MM/AF	g		€
<b>50839000680</b>	50839	160		6	0 - 20 0 - 1/4"	160	5	<b>12,35</b>
<b>50839000880</b>	50839	205		8	0 - 25 0 - 1"	310	5	<b>15,55</b>
<b>50839001080</b>	50839	255		10	0 - 30 0 - 1.1/4"	540	5	<b>22,00</b>
<b>50839001280</b>	50839	305		12	0 - 35 0 - 1.1/2"	800	5	<b>28,60</b>

## K 50839-3

### Sätze mit verstellbaren Einmaulschlüsseln

### Adjustable wrenches set

Set met verstelbare  
moersleutels

### Jeux de clés à molette

Juegos de llaves ajustables



Bestell-No./Order-No.	Art. No.	MM/AF	g		€
<b>50839000100</b>	K 50839-3	0 - 30 0 - 1.1/4"	1010	1	<b>48,15</b>

enthaltend je 1 St./containing each 1 pcs.: 50839-6 · 50839-8 · 50839-10



## 50839

- Geschmiedeter, gehärteter Schlüsselkörper aus hochwertigem Chrom-Vanadium-Stahl mit geschliffenem Schlüsselkopf, mit Nickel-Chromschicht galvanisiert gegen Korrosion, spezialgehärtete, gefräste Greifbacken
- Präzise Führung des gehärteten Schneckenrads
- Amerikanisches Modell mit 22° Maulstellung, rechtsgängig
- Chrome-Vanadium steel body, drop forged and hardened, polished head, nickel and chromium plated for protection against corrosion, specially hardened and milled jaws
- Precise running of hardened worm-wheel
- American pattern with 22° angled head and right hand movement



**50805**  
DIN 838 / ISO 1085



**Doppelringschlüssel,  
tief gekröpft**

Chrom-Vanadium, verchromt,  
Schon-Profil

Double ended ring wrenches,  
deep offset

Chrome-Vanadium, chromium plated,  
profile saver

Ringsleutel, diep gebogen  
Chroom-Vanadium, verchromd,  
profiel beschermer

Clés polygonales contre-  
coudées

Chrome-Vanadium, chromées,  
profil de protection SP

Llaves de estrella acodadas,  
de dos bocas

Cromo Vanadio, cromadas, acodado  
profundo, perfil especial SP

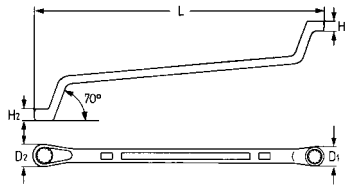

Bestell-No./Order-No.	MM	CL mm	H1 mm	H2 mm	D1 mm	D2 mm	g	mm	€
<b>50805060780</b>	6 x 7	165	5,9	6,5	11,1	12,5	40	10	<b>3,60</b>
<b>50805080980</b>	8 x 9	180	6,9	7,4	14,3	15,5	58	10	<b>3,75</b>
<b>50805101180</b>	10 x 11	200	7,8	8,3	17,2	18,4	72	10	<b>4,00</b>
<b>50805101380</b>	10 x 13	220	7,4	8,7	15,4	19,8	100	10	<b>4,30</b>
<b>50805121380</b>	12 x 13	220	8,8	9,3	20,6	21,3	108	10	<b>4,30</b>
<b>50805141580</b>	14 x 15	245	9,7	10,2	23,3	24,2	140	10	<b>4,70</b>
<b>50805161780</b>	16 x 17	255	10,6	10,9	26,4	27,2	175	5	<b>5,30</b>
<b>50805171980</b>	17 x 19	285	12,0	12,0	26,8	28,5	285	5	<b>7,80</b>
<b>50805181980</b>	18 x 19	275	11,3	11,6	29,1	30,1	235	5	<b>6,60</b>
<b>50805192280</b>	19 x 22	285	11,8	12,3	30,2	31,3	275	5	<b>8,65</b>
<b>50805202280</b>	20 x 22	300	12,0	12,7	31,1	34,0	285	5	<b>8,10</b>
<b>50805212380</b>	21 x 23	315	12,4	13,1	33,0	36,0	305	5	<b>8,95</b>
<b>50805242780</b>	24 x 27	330	13,4	14,5	38,5	41,9	360	5	<b>10,35</b>
<b>50805252880</b>	25 x 28	350	13,8	14,9	40,4	43,9	450	5	<b>11,50</b>
<b>50805303280</b>	30 x 32	365	15,9	16,5	46,8	49,3	550	5	<b>13,85</b>

**K 50805**  
**R 50805**  
**HP 50805**

DIN 838 / ISO 1085

**Doppelringschlüssel-Sätze,  
tief gekröpft**

Chrom-Vanadium, verchromt,  
Schon-Profil

Double ended ring wrenches  
sets, deep offset

Chrome-Vanadium, chromium plated,  
profile saver

Ringsleutelsets, diep gebogen  
Chroom-Vanadium, verchromd,  
profiel beschermer

Jeux de clés polygonales  
contre-coudées

Chrome-Vanadium, chromées,  
profil de protection SP

Juegos de llaves de estrella  
acodadas, de dos bocas

Cromo Vanadio, cromadas, acodado  
profundo, perfil especial SP



R 50805



HP 50805



K 50805

Bestell-No./Order-No.	Art. No.	MM	g	mm	€
<b>50805944080</b>	K-50805-8-M	6x7 / 8x9 / 10x11 / 12x13 / 14x15 / 16x17 / 18x19 / 20x22	1120	1	<b>36,95</b>
<b>50805947080</b>	K-50805-12-M	6x7 / 8x9 / 10x11 / 12x13 / 14x15 / 16x17 / 18x19 / 20x22 / 21x23 / 24x27 / 25x28 / 30x32	2950	1	<b>77,25</b>
<b>50805747080</b>	R-50805-12-M	6x7 / 8x9 / 10x11 / 12x13 / 14x15 / 16x17 / 18x19 / 20x22 / 21x23 / 24x27 / 25x28 / 30x32	3100	1	<b>92,10</b>
<b>50805644080</b>	HP-50805-8-M	6x7 / 8x9 / 10x11 / 12x13 / 14x15 / 16x17 / 18x19 / 20x22	1320	1	<b>46,00</b>

**DAS HEYTEC-SCHONPROFIL**

Schont Schrauben und Muttern. Setzt an den Flächen und nicht an den Kanten an. Eine positive Auswirkung ist die erheblich längere Lebensdauer.

**THE HEYTEC-PROFILE SAVER**

Protects screws and nuts whilst forces are applied on the flanks and not on edges, providing a much extended lifetime.



## 50720

### Knarren-Ringmaulschlüssel

Chrom-Vanadium, verchromt, 72 Zähne, Drehmoment Ring nach DIN 899 Reihe A / ISO 1711-1, Maul nach DIN 899 Reihe C / ISO 1711

### Combination ratchet wrenches

Chrome-Vanadium, chromium plated, 72 teeth, torque on ring to DIN 899 row A / ISO 1711-1, on open end to DIN 899 row C / ISO 1711

### Ringratel-steeksleutels

Chroom-Vanadium, verchromd, 72 tanden, draaimoment-ring volgens DIN 899 rij A / ISO 1711-1, bek volgens DIN 899 rij C / ISO 1711

### Clés mixtes à cliquet

Chrome-Vanadium, chromées, 72 dents, couple côté polygonal suivant DIN 899 rang A / ISO 1711-1, fourche suivant DIN 899 rang C / ISO 1711

### Llaves combinadas boca

estrella con carraca

Cromo Vanadio, cromadas, par de apriete: boca estrella según DIN 899 serie A / ISO 1711-1, boca abierta según DIN 899 serie C / ISO 1711

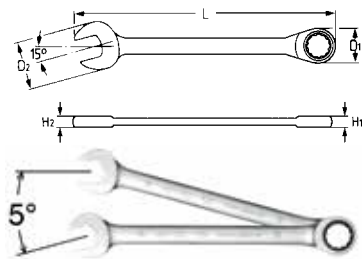

Bestell-No./Order-No.	ØMM	CL mm	H1 mm	H2 mm	D1 mm	D2 mm	g	mm	€
<b>50720008080</b>	8	140,0	6,6	4,6	17,0	16,8	32	10	<b>15,75</b>
<b>50720009080</b>	9	150,0	7,0	5,0	19,5	18,5	40	10	<b>16,30</b>
<b>50720010080</b>	10	160,0	7,5	5,3	20,5	20,8	59	10	<b>16,45</b>
<b>50720011080</b>	11	165,0	8,0	6,0	22,2	23,0	70	10	<b>17,20</b>
<b>50720012080</b>	12	172,0	8,3	6,3	23,0	25,3	77	10	<b>18,25</b>
<b>50720013080</b>	13	178,0	8,7	6,6	25,3	27,2	85	10	<b>19,60</b>
<b>50720014080</b>	14	190,0	9,0	6,8	28,2	29,2	105	10	<b>19,85</b>
<b>50720015080</b>	15	200,0	9,5	7,0	29,2	31,5	125	10	<b>20,80</b>
<b>50720016080</b>	16	207,0	10,0	7,5	30,0	32,8	225	10	<b>22,10</b>
<b>50720017080</b>	17	225,0	10,3	7,7	31,7	35,0	160	10	<b>23,00</b>
<b>50720018080</b>	18	240,0	11,5	8,3	32,2	37,5	200	10	<b>24,65</b>
<b>50720019080</b>	19	248,0	10,3	8,7	34,3	39,5	210	10	<b>25,25</b>
<b>50720022080</b>	22	278,0	10,3	9,0	42,0	45,0	381	10	<b>29,20</b>
<b>50720024080</b>	24	300,8	13,4	9,9	46,7	51,5	500	5	<b>34,90</b>
<b>50720027080</b>	27	304,1	14,9	10,9	48,7	55,9	601	5	<b>51,85</b>

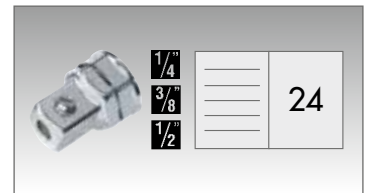
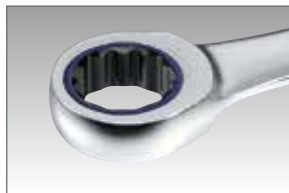

## K 50720 R 50720 M 50720

### Knarren-Ringmaulschlüssel-Sätze

Combination ratchet wrenches sets

Ringratel-steeksleutels

Jeux de clés mixtes à cliquet

Juegos de llaves combinadas boca estrella con carraca



R 50720



M 50720



K 50720

Bestell-No./Order-No.	Art. No.	ØMM	g	mm	€
<b>50720600080</b>	K 50720-6-M	8/10/12/13/17/19	623	1	<b>102,55</b>
<b>50720600180</b>	R 50720-6-M	8/10/12/13/17/19	755	1	<b>115,55</b>
<b>50720600380</b>	R 50720-8-M	8/10/12/13/14/15/17/19	1005	1	<b>149,40</b>
<b>50720600280</b>	M 50720-10-M	8/10/12/13/14/15/16/17/18/19	1400	1	<b>201,35</b>

## 50725

### Knarren-Ringmaulschlüssel, umschaltbar

Chrom-Vanadium, verchromt, 72 Zähne, Drehmoment Ring nach DIN 899 Reihe A / ISO 1711-1, Maul nach DIN 899 Reihe C / ISO 1711

Combination ratchet wrenches, reversible

Chrome-Vanadium, chromium plated, 72 teeth, torque on ring to DIN 899 row A / ISO 1711-1, on open end to DIN 899 row C / ISO 1711

### Omschakelbare ringratel-steeksleutel

Chroom-Vanadium, verchromd, 72 tanden, draaimoment-ring volgens DIN 899 rij A / ISO 1711-1, bek volgens DIN 899 rij C / ISO 1711

### Clés mixtes à cliquet réversible

Chrome-Vanadium, chromées, 72 dents, couple côté polygonal suivant DIN 899 rang A / ISO 1711-1, fourche suivant DIN 899 rang C / ISO 1711

### Llaves combinadas boca estrella con carraca reversible

Cromo Vanadio, cromadas, par de apriete: boca estrella según DIN 899 serie A / ISO 1711-1, boca abierta según DIN 899 serie C / ISO 1711



Bestell-No./Order-No.	ØMM	CL mm	H1 mm	H2 mm	D1 mm	D2 mm	g	mm	€
<b>507250080</b>	8	140,0	8,2	5,3	17,0	17,0	37	10	<b>21,40</b>
<b>507250090</b>	9	150,0	8,2	5,5	19,0	18,8	47	10	<b>21,40</b>
<b>507250100</b>	10	160,0	8,4	6,0	20,5	21,7	62	10	<b>22,45</b>
<b>507250110</b>	11	165,0	9,4	6,4	21,5	23,0	71	10	<b>22,45</b>
<b>507250120</b>	12	170,0	9,4	6,5	22,5	25,2	84	10	<b>22,95</b>
<b>507250130</b>	13	178,0	9,4	7,3	24,0	26,5	95	10	<b>22,95</b>
<b>507250140</b>	14	190,0	9,4	7,5	26,5	29,6	112	10	<b>26,85</b>
<b>507250150</b>	15	200,0	9,4	7,8	28,0	31,3	142	10	<b>26,85</b>
<b>507250160</b>	16	210,0	11,1	8,1	29,0	33,4	155	10	<b>31,80</b>
<b>507250170</b>	17	225,0	11,1	8,4	30,5	36,3	175	10	<b>31,80</b>
<b>507250180</b>	18	237,0	12,4	9,1	31,5	38,0	210	10	<b>34,15</b>
<b>507250190</b>	19	248,0	12,4	9,3	33,0	39,0	235	10	<b>34,15</b>
<b>507250220</b>	22	290,0	13,0	9,3	39,0	46,0	380	10	<b>50,55</b>
<b>507250240</b>	24	335,0	14,5	10,4	45,5	52,3	530	5	<b>61,00</b>
<b>507250270</b>	27	353,0	14,8	11,6	51,8	58,5	624	5	<b>62,25</b>
<b>507250300</b>	30	419,0	16,8	12,2	59,3	64,5	939	5	<b>79,55</b>
<b>507250320</b>	32	420,0	16,9	12,2	59,5	64,6	942	5	<b>82,55</b>

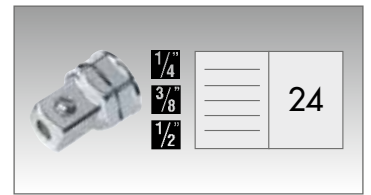
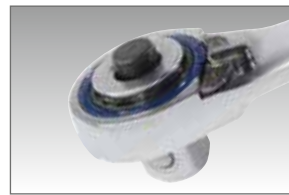
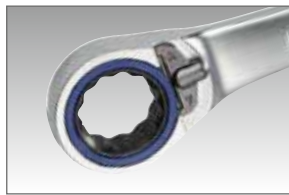
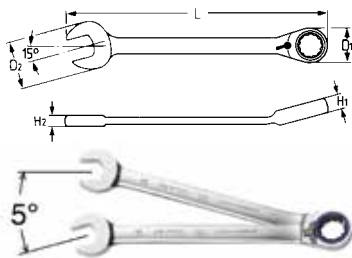

## K 50725 R 50725 M 50725

### Knarren-Ringmaulschlüssel-Sätze, umschaltbar

Combination ratchet wrenches sets, reversible

### Omschakelbare ringratel-steeksleutelset

Jeux de clés mixtes à cliquet réversible

Juegos de llaves combinadas boca estrella con carraca reversible



R 50725-8



M 50725

K 50725

Bestell-No./Order-No.	Art. No.	ØMM	g	mm	€
<b>50725600080</b>	K 50725-6-M	8/10/12/13/17/19	690	1	<b>128,55</b>
<b>50725600180</b>	R 50725-6-M	8/10/12/13/17/19	825	1	<b>141,50</b>
<b>50725600380</b>	R 50725-8-M	8/10/12/13/14/15/17/19	974	1	<b>193,50</b>
<b>50725600280</b>	M 50725-10-M	8/10/11/12/13/14/16/17/18/19	1550	1	<b>219,50</b>

**50725-6005**

10-tlg./pcs./dlg./pces./pzs.



**Knarren-Ringmaulschlüssel-Satz**

Multifunktion 3 in 1  
Maulschlüssel, Ringschlüssel, Knarre

Combination ratchet wrenches set

Multifunction 3 in 1  
Open jaw wrenches, ring wrenches, ratchet

Omschakelbare ringratel-steeksleutelset

Multifunctie 3-in-1  
Steeksleutel, ringsleutel, ratel



Jeu de clés mixtes à cliquet

Multifonction 3 en 1  
Clé plate, clé polygonale, cliquet



Juego de llaves combinadas con carraca

Multiusos 3 en 1  
Llave de boca, llave de estrella, carraca

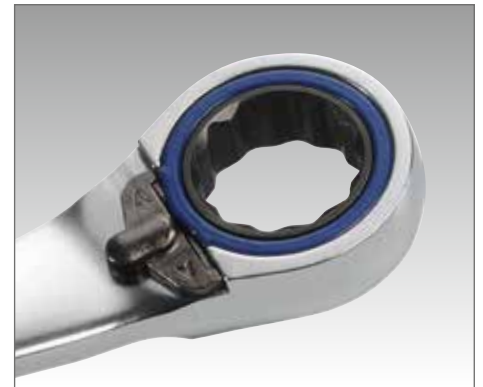

enthaltend/containing	
	MM 8/10/11/13/14/17/19
	1/4" / 3/8" / 1/2"



Bestell-No./Order-No.	Art. No.	Maße - Dimensions			€
<b>50725600580</b>	50725-6005	250 x 140 x 40	1600	1	<b>164,05</b>



**50725-6005**

- Knarren-Ringmaulschlüssel aus Chrom-Vanadium Stahl, verchromt, mit Hebelumschaltung, 72 Zähne, Drehmoment Ring nach DIN 899 Reihe A / ISO 1711-1, Maul nach DIN 899 Reihe C / ISO 1711
- Combination ratchet wrench, made of Chrome-Vanadium steel, chromium plated, 72 teeth, torque on ring to DIN 899 row A / ISO 1711-1, on open end to DIN 899 row C / ISO 1711

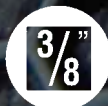

## 50730

4 in 1

### Knarren-Ringschlüssel

Chrom-Vanadium, verchromt,  
mit Hebelumschaltung, 72 Zähne

### Ratchet wrenches

Chrome-Vanadium, chromium plated,  
with reversible ratchet, 72 teeth

### Ringratel-steeksleutel

Chrom-Vanadium, verchromd, met  
omschakelpal, 72 tanden

### Clé polygonale à cliquet

Chrome-Vanadium, chromées,  
avec cliquet réversible, 72 dents

### Llave boca estrella con carraca

Cromo Vanadio, cromada,  
con carraca reversible, 72 dientes



Bestell-No./Order-No.	Art. No.	CLD mm	MM	g		€
<b>50730081383</b>	50730	165	8 x 10 x 12 x 13	105	5	<b>32,40</b>
<b>50730091583</b>	50730	180	9 x 11 x 14 x 15	150	5	<b>36,75</b>
<b>50730101983</b>	50730	251	10 x 13 x 17 x 19	273	5	<b>45,80</b>
<b>50730161983</b>	50730	225	16 x 17 x 18 x 19	255	5	<b>41,95</b>
<b>50730202483</b>	50730	255	20 x 21 x 22 x 24	480	5	<b>72,10</b>



## R 50730-3

4 in 1

3-tlg./pcs./-dlg./pces./pzs.

### Knarren-Ringschlüssel-Satz

In stabiler Textil- Gürteltasche mit  
Klettverschluss

### Ratchet wrenches set

In solid textile belt bag with velcro sealing

### Ringratel-steeksleutelset

In stevige nylon tas met klittebandsluiting

### Jeu de clés polygonales à cliquet

En étui de ceinture résistant avec  
fermeture velcro

### Juegos de llaves boca estrella con carraca

En cinturón portaherramientas de tela,  
con cierre de velcro



Bestell-No./Order-No.	Art. No.	MM	g		€
<b>50730600183</b>	R 50730-3	8 x 10 x 12 x 13 9 x 11 x 14 x 15 16 x 17 x 18 x 19	495	1	<b>116,70</b>

## 50825-/50840-/50850-12

### Adapter für Knarren-Ringmaulschlüssel

Adapter for  
combination ratchet wrenches

Adapter voor  
ringratel-steeksleutel

Adaptateurs pour  
clés à cliquet

Adaptador para llaves combina-  
das boca estrella con carraca

1/4"

3/8"

1/2"



Bestell-No./Order-No.	Art. No.	■	für · for HEYTEC No.	MM	g		€
<b>50825121083</b>	50825-1210	1/4"	50720	10	6	10	<b>10,00</b>
<b>50840121383</b>	50840-1213	3/8"	+	13	18	10	<b>10,00</b>
<b>50850121983</b>	50850-1219	1/2"	50725	19	50	10	<b>11,35</b>





## Gerüstbauknarre

Scaffolding ratchet

Werfpunratel

Outils pour monteurs  
d'échafaudages

Llave de carraca para  
montaje de andamios

Chrom-Vanadium, verchromt.  
Extrem stabile Modelle, mit Umschaltknarre und  
einem Durchlass für den Gewindebolzen.

Chrome-Vanadium, chromium plated.  
Extremely robust products with  
reversible ratchet and pass-through feature  
for threaded bolts.

### 50740

Das Ende des Handgriffs ist als Dorn  
ausgeführt und ermöglicht somit ein  
schnelles Justieren der Bauteile.

With „rat-tail“ handle for aligning  
construction parts.

Uitgevoerd met centreerpunt voor het snel  
justeren van boutgaten.

L'extrémité de la poignée est conçue en  
forme de pointe et permet ainsi un ajuste-  
ment rapide des éléments à assembler.

El mango termina en cono para un ajuste  
rápido de los elementos del andamio.  
Bolso de cinturón.



Bestell-No./Order-No.	Art. No.	CLD mm	MM	g		€
50740192236	50740	315	19 x 22	150	2	35,85

### 50742

#### mit Nagelzieher

Mit integriertem ausklappbarem Nagel-  
zieher. Das Ende des Handgriffs ist als  
Dorn ausgeführt und ermöglicht somit ein  
schnelles Justieren der Bauteile.

with nail puller

With integrated fold-out nail puller. With  
rat-tail handle for aligning construction parts.

met spijkertrekker

Met geïntegreerde, uitklapbare spijker-  
trekker. Het einde van de greep is als  
doorn uitgevoerd en maakt snel uitlijnen  
van bouwdeelen mogelijk.

avec arrache-clous

Avec arrache clous pliable intégré.  
L'extrémité de la poignée est conçue  
en forme de pointe et permet ainsi un  
réglage rapide des composants.

con extractor de clavos

Con extractor de clavos plegable  
integrado. El mango termina en cono  
para el alineamiento rápido de los  
elementos del andamio.



Bestell-No./Order-No.	Art. No.	CLD mm	MM	g		€
50742192280	50742	315	19 x 22	1400	2	45,35

$1/4''$

$3/8''$

$1/2''$

$3/4''$







Chrom-Vanadium, verchromt  
 Chrome-Vanadium, chromium plated

### Hebelumschaltknarre

Mit Auswerferstift zum Schnelllösen der Steckverbindung.

Lever type reversible ratchet  
 With quick release ejector button.

Omschakelbare ratel  
 Met pal, met ontgrendelstift.

Cliquets réversibles  
 Tige d'éjection pour libérer rapidement l'outil du cliquet.

Carraca reversible  
 Con expulsor para separación instantánea de vasos y accesorios.

### 50825-00-15

DIN 3122 D · ISO 3315

48 Zähne/teeth/tanden/dents/dientes

Mit ergonomischem 2-K Griff.

With ergonomic 2 components handle.

Met ergonomische 2 componenten greep.

Avec poignée ergonomique bimatière.

Con mango ergonómico de dos componentes.



Bestell-No./Order-No.	Art. No.		CLD mm			€
<b>50825015083</b>	50825-00-15	1/4"	150	135	5	<b>24,55</b>

### 50825-00-17

48 Zähne/teeth/tanden/dents/dientes

Arretierbar mit ergonomischem 2-K Griff und Gürtelclip.

Lockable with ergonomic 2 components handle and belt clip.

Knikbaar, met ergonomische 2 componenten greep en riemclip.

Cliquet articulé avec poignée ergonomique bimatière et adaptateur de ceinture.

Bloqueable con mango ergonómico de dos componentes más clip para el cinturón.



Bestell-No./Order-No.	Art. No.		CLD mm			€
<b>50825017083</b>	50825-00-17	1/4"	140	146	5	<b>33,60</b>

### 50825-10-16

72 Zähne/teeth/tanden/dents/dientes

Gebogener Stahlkern.

Offset handle.

Gebogen stalen kern.

Poignée courbée en acier.

Mango acodado.



Bestell-No./Order-No.	Art. No.		CLD mm			€
<b>50825101680</b>	50825-10-16	1/4"	150	250	5	<b>24,55</b>

**1/4"****HEYTEL  
TOOLS****50825-10-17**

60 Zähne/teeth/tanden/dents/dientes

Mit Auswerferstift zum Schnellösen der Steckverbindung. Mit ergonomischem 2-K Griff. 30% mehr Drehmoment durch innovative Sperrfunktion.

With quick release ejector button. With ergonomic 2 components handle. Innovative locking function for 30% higher torque.

Met ontgrendelstift. Met ergonomische 2 componenten greep. 30% meer draaimoment door innovatieve blokkeerfunctie.

Tige d'éjection pour libérer rapidement l'outil du cliquet. Avec poignée ergonomique bimatière. 30% plus de couple grâce à la fonction de blocage innovante.

Con expulsor para separación instantánea de vasos y accesorios. Con mango ergonómico de dos componentes. Par de apriete aumentado en un 30% gracias a la función de bloqueo innovador.

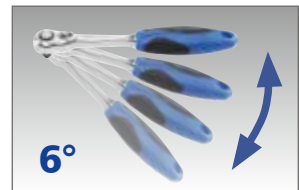

Extrem schlank, bestens geeignet für enge Bauräume.  
Extremely slim, best suited for places of hard access.



Bestell-No./Order-No.	Art. No.		$\varnothing$ mm			€
<b>50825101783</b>	50825-10-17	1/4"	150	150	5	<b>24,55</b>

**50825-11-15**

48 Zähne/teeth/tanden/dents/dientes

Mit Auswerferstift zum Schnellösen der Steckverbindung. Mit ergonomischem 2-K Griff.

With quick release ejector button. With ergonomic 2 components handle.

Met ontgrendelstift. Met ergonomische 2 componenten greep.

Tige d'éjection pour libérer rapidement l'outil du cliquet. Avec poignée ergonomique bimatière.

Con expulsor para separación instantánea de vasos y accesorios. Con mango ergonómico de dos componentes.



Ideal für schwer zugängliche Stellen.  
Ideal for hard of access workplaces.

Bestell-No./Order-No.	Art. No.		$\varnothing$ mm			€
<b>50825111583</b>	50825-11-15	1/4"	115	94	5	<b>24,55</b>

**50825-00-18**

48 Zähne/teeth/tanden/dents/dientes

**T-Griff mit Ratschenfunktion**

Mit Auswerferstift zum Schnellösen der Steckverbindung. Arretierbar, aus Zink-Druckguß in schwerer Ausführung.

T-handle with ratchet

With quick release ejector button. Made of heavy duty die-cast zinc, with quick release mechanism.

T-greep met ratelfunctie

Met ontgrendelstift. Knikbaar, uit spuitgietzink, zware uitvoering.

T-poignée cliquet

Tige d'éjection pour libérer rapidement l'outil du cliquet. En zamac avec mécanisme de déconnexion rapide.

Mango en T con carraca

Con expulsor para separación instantánea de vasos y accesorios. Acabado en zinc colado a presión en ejecución fuerte con mecanismo de separación instantánea.



Mit Schnellösemechanik und rechts/links-Umschaltung.  
Stop-function and right-left switch.



Bestell-No./Order-No.	Art. No.		$\varnothing$ mm			€
<b>50825018083</b>	50825-00-18	1/4"	115	146	5	<b>27,75</b>



### 50833-3-1

48 Zähne/teeth/tanden/dents/dientes

#### Mini-Bit-Knarre

Mit Auswerferstift zum Schnelllösen der Steckverbindung. Blau eloxiert.

#### Mini-bit ratchet

With quick release ejector button. Blue anodized.

#### Mini ratelbithouder

Met ontgrendelstift. Blauw geëloxeerd.

#### Mini cliquet à embouts

Tige d'éjection pour libérer rapidement l'outil du cliquet. Bleu anodisé.

#### Carraca mini para

Con expulsor para separación instantánea de vasos y accesorios. Anodizado azul.



Rechts/links-Umschaltung, zur Aufnahme von Bits.  
Reversible (clockwise/counter-clockwise), for direct adaption of bits.

Bestell-No./Order-No.	Art. No.		CLD mm			€
<b>50833300100</b>	50833-3-1	1/4"	85	46	5	<b>20,70</b>

### 50825-03

DIN 3123 B · ISO 3316

#### Griff mit Gleitstück

Sliding Thandle

Greep met schuifstuk

Poignée coulissante

Mango corredizo



Bestell-No./Order-No.	Art. No.		CLD mm			€
<b>50825030083</b>	50825-03	1/4"	115	42	10	<b>4,80</b>

### 50825-04/05/05-5

DIN 3123 B · ISO 3316

#### Verlängerungen

Extension bars

Verlengstukken

Rallonges

Alargaderas



50825-04



50825-05



50825-05-5



50825-05-5

Bestell-No./Order-No.	Art. No.		CLD mm			€
<b>50825040083</b>	50825-04	1/4"	50	35	10	<b>2,75</b>
<b>50825050083</b>	50825-05	1/4"	100	44	10	<b>3,05</b>
<b>50825055083</b>	50825-05-5	1/4"	102	43	5	<b>5,15</b>

### 50825-05-6/-7

#### Verlängerungen mit Zugbetätigung

Zum Schnelllösen und zur Arretierung der Steckverbindung.

Extension bars

With quick release.

Verlengstukken

Met snelwissel mechanisme.

Rallonges

Avec déconnexion rapide automatique ou blocage du connecteur.

Alargaderas

Con telemando para separación instantánea e inmovilización del conector.



50825-05-6



50825-05-7

Bestell-No./Order-No.	Art. No.		CLD mm			€
<b>50825056083</b>	50825-05-6	1/4"	100	49	10	<b>9,75</b>
<b>50825057083</b>	50825-05-7	1/4"	250	109	5	<b>13,20</b>



### 50825-08

DIN 3122 E · ISO 3315

#### Steckgriff

Spinner handle

Schroevendraaiergreep

Rallonge emmanchée

Mango recto



Bestell-No./Order-No.	Art. No.		CLØ mm			€
<b>50825080083</b>	50825-08	1/4"	150	98	10	<b>4,80</b>

### 50825-06

DIN 3123 C · ISO 3316

#### Kardangelen

Universal joint

Kardangewricht

Cardan universel

Articulaciones universales



Bestell-No./Order-No.	Art. No.		CLØ mm			€
<b>50825060083</b>	50825-06	1/4"	37	26	10	<b>6,85</b>

### 50825-6

DIN 3124 / ISO 2725

#### Steckschlüsseleinsätze, sechskant

Chrom-Vanadium, verchromt

Sockets, hexagon

Chrome-Vanadium, chromium plated

Dopsleutels, zeskant

Chroom-Vanadium, verchroomd

Douilles, 6 pans

Chrome-Vanadium, chromées

Llaves de vaso, boca hexagonal

Cromo Vanadio, cromadas

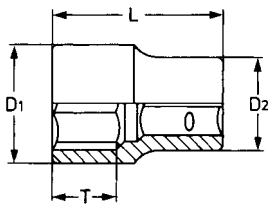

Bestell-No./Order-No.		CLØ mm	T mm	D1 mm	D2 mm			€
<b>50825600483</b>	4	25,0	9,0	7,0	12,0	9	10	<b>1,45</b>
<b>50825604583</b>	4,5	25,0	9,0	7,0	12,0	10	10	<b>1,45</b>
<b>50825600583</b>	5	25,0	9,0	8,0	12,0	10	10	<b>1,45</b>
<b>50825605583</b>	5,5	25,0	9,0	9,0	12,0	9	10	<b>1,45</b>
<b>50825600683</b>	6	25,0	9,0	9,0	12,0	10	10	<b>1,45</b>
<b>50825600783</b>	7	25,0	9,0	10,0	12,0	11	10	<b>1,45</b>
<b>50825600883</b>	8	25,0	9,0	12,0	12,0	12	10	<b>1,45</b>
<b>50825600983</b>	9	25,0	11,0	13,0	13,0	14	10	<b>1,45</b>
<b>50825601083</b>	10	25,0	11,0	14,0	14,0	15	10	<b>1,45</b>
<b>50825601183</b>	11	25,0	12,0	16,0	16,0	21	10	<b>1,85</b>
<b>50825601283</b>	12	25,0	13,0	17,0	17,0	24	10	<b>1,85</b>
<b>50825601383</b>	13	25,0	13,0	18,0	18,0	27	10	<b>1,85</b>
<b>50825601483</b>	14	25,0	14,0	19,5	19,5	34	10	<b>2,00</b>
<b>50825601583</b>	15	25,0	15,0	21,5	21,5	52	10	<b>2,20</b>

### 50825-19

DIN 3124 / ISO 2725

#### Steckschlüsseleinsätze, extra lang

Chrom-Vanadium, verchromt

Sockets, extra deep

Chrome-Vanadium, chromium plated

Dopsleutels, verlengd

Chroom-Vanadium, verchroomd

Douilles, extra longues

Chrome-Vanadium, chromées

Llaves de vaso, extra-largas

Cromo Vanadio, cromadas

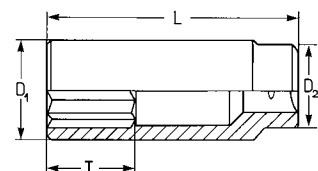

Bestell-No./Order-No.		CLØ mm	T mm	D1 mm	D2 mm			€
<b>50825190683</b>	6	50,0	12,0	10,0	12,0	22	10	<b>2,50</b>
<b>50825190783</b>	7	50,0	19,0	10,5	12,0	23	10	<b>2,50</b>
<b>50825190883</b>	8	50,0	19,0	12,0	12,0	25	10	<b>2,50</b>
<b>50825190983</b>	9	50,0	19,0	13,0	12,0	29	10	<b>2,50</b>
<b>50825191083</b>	10	50,0	21,0	14,5	13,0	35	10	<b>2,60</b>
<b>50825191183</b>	11	50,0	23,0	16,0	14,0	42	10	<b>2,65</b>
<b>50825191283</b>	12	50,0	23,0	17,0	15,0	45	10	<b>2,70</b>
<b>50825191383</b>	13	50,0	23,0	18,0	16,0	52	10	<b>2,70</b>
<b>50825191483</b>	14	50,0	23,0	19,0	17,0	55	10	<b>2,90</b>

**1/4"**

**50825-20**

Steckschlüsseinsätze  
für Außen-TORX®-Schrauben  
Chrom-Vanadium, verchromt

Sockets for  
TORX®-head screws  
Chrome-Vanadium, chromium plated

Dopsleutels voor  
TORX® bouten  
Chroom-Vanadium, verchromd

Douilles pour vis  
TORX® extérieures  
Chrome-Vanadium, chromées

Llaves de vaso para tornillos  
TORX® exteriores  
Cromo Vanadio, cromadas

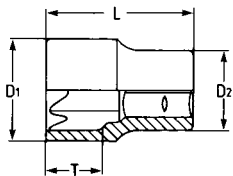

Bestell-No./Order-No.	E	mm	mm	T mm	D1 mm	D2 mm	g		€
<b>50825200483</b>	4	3,86	25,0	7,0	7,0	12,0	10	10	<b>2,55</b>
<b>50825200583</b>	5	4,75	25,0	7,0	8,0	12,0	10	10	<b>2,55</b>
<b>50825200683</b>	6	5,74	25,0	7,0	9,0	12,0	11	10	<b>2,55</b>
<b>50825200783</b>	7	6,22	25,0	12,0	11,0	12,0	12	10	<b>2,55</b>
<b>50825200883</b>	8	7,52	25,0	12,0	12,0	12,0	13	10	<b>2,55</b>
<b>50825201083</b>	10	9,42	25,0	12,0	14,0	14,0	15	10	<b>2,70</b>
<b>50825201183</b>	11	10,08	25,0	12,0	16,0	16,0	19	10	<b>2,70</b>

**50825-30 – 50825-37**

Schraubendreher-Einsätze  
Chrom-Vanadium, verchromt

Screwdriver sockets  
Chrome-Vanadium, chromium plated

Schroevendraaier dopsleutels  
Chroom-Vanadium, verchromd

Douilles tournevis  
Chrome-Vanadium, chromées

Llaves de vaso con  
destornillador  
Cromo Vanadio, cromadas

**1/4"**



Bestell-No./Order-No.	Art. No.	mm	mm	L1 mm	L2 mm	D2 mm	g		€
<b>50825300383</b>	50825-30	4,0	0,7	36,0	18,0	12,0	15	10	<b>1,85</b>
<b>50825300483</b>	50825-30	5,5	0,9	36,0	18,0	12,0	15	10	<b>1,85</b>
<b>50825300583</b>	50825-30	7,0	1,0	36,0	18,0	12,0	15	10	<b>1,85</b>

Bestell-No./Order-No.	Art. No.	MM	L1 mm	L2 mm	D2 mm	g		€
<b>50825310183</b>	50825-31	3,0	36,0	17,0	12,0	15	10	<b>1,85</b>
<b>50825310283</b>	50825-31	4,0	36,0	17,0	12,0	15	10	<b>1,85</b>
<b>50825310383</b>	50825-31	5,0	36,0	17,0	12,0	15	10	<b>1,85</b>
<b>50825310583</b>	50825-31	5,5	36,0	17,0	12,0	15	10	<b>1,85</b>
<b>50825310483</b>	50825-31	6,0	36,0	17,0	12,0	15	10	<b>1,85</b>

Bestell-No./Order-No.	Art. No.	+	L1 mm	L2 mm	D2 mm	g		€
<b>50825320183</b>	50825-32	PH 1	36,0	17,0	12,0	15	10	<b>1,85</b>
<b>50825320283</b>	50825-32	PH 2	36,0	17,0	12,0	15	10	<b>1,85</b>
<b>50825320383</b>	50825-32	PH 3	36,0	17,0	12,0	15	10	<b>1,85</b>

Bestell-No./Order-No.	Art. No.		L1 mm	L2 mm	D2 mm	g		€
<b>50825330183</b>	50825-33	M5	36,0	17,0	12,0	15	10	<b>2,20</b>
<b>50825330283</b>	50825-33	M6	36,0	17,0	12,0	15	10	<b>2,20</b>
<b>50825330383</b>	50825-33	M8	36,0	17,0	12,0	15	10	<b>2,20</b>

Bestell-No./Order-No.	Art. No.	*	L1 mm	L2 mm	D2 mm	g		€
<b>50825350183</b>	50825-35	PZ 1	36,0	17,0	12,0	15	10	<b>2,20</b>
<b>50825350283</b>	50825-35	PZ 2	36,0	17,0	12,0	15	10	<b>2,20</b>
<b>50825350383</b>	50825-35	PZ 3	36,0	17,0	12,0	15	10	<b>2,20</b>

Bestell-No./Order-No.	Art. No.		mm	L1 mm	L2 mm	D2 mm	g		€
<b>50825370883</b>	50825-37	TT 8	2,52	37,0	17,0	12,0	15	10	<b>2,35</b>
<b>50825371083</b>	50825-37	TT 10	2,68	37,0	17,0	12,0	15	10	<b>2,35</b>
<b>50825371583</b>	50825-37	TT 15	3,48	37,0	17,0	12,0	15	10	<b>2,35</b>
<b>50825372083</b>	50825-37	TT 20	3,75	37,0	17,0	12,0	15	10	<b>2,35</b>
<b>50825372583</b>	50825-37	TT 25	4,25	37,0	17,0	12,0	15	10	<b>2,35</b>
<b>50825372783</b>	50825-37	TT 27	5,00	37,0	17,0	12,0	15	10	<b>2,35</b>
<b>50825373083</b>	50825-37	TT 30	5,55	37,0	17,0	12,0	15	10	<b>2,35</b>
<b>50825374083</b>	50825-37	TT 40	6,50	37,0	17,0	12,0	15	10	<b>2,35</b>

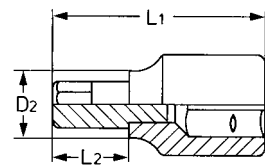





### 50825-1501

DIN 3123 A · ISO 3316

Adapter

Converter

Adapter

Réducteur

Reductor



Bestell-No./Order-No.	Art. No.	■	○	CL Ø mm	g	mm	€
<b>50825150183</b>	50825-1501	3/8"	1/4"	25	21	10	<b>3,45</b>

### 50800-3306

Adapter für 1/4" Bits

Innensechskant, mit Halteklammer

Adapter for 1/4" bits

Internal hexagon with holding clip

Adapter voor 1/4" bits

Met binnenzeskant, met klem

Adaptateur pour embouts 1/4"

6-pans femelle, avec clavette de blocage

Adaptador para puntas de 1/4"

Exágono interior, con pinza de sujeción



Bestell-No./Order-No.	Art. No.	○ ■	CL Ø mm	g	mm	€
<b>50800330683</b>	50800-3306	1/4"	25	20	10	<b>2,05</b>

### 5083301-1

Magnet Bithalter

Mit Dauermagnet. Sicherheitsarretierung durch Dauermagnet und formschlüssige Arretierung. Einfache Entnahme durch Auswurfbetätigung.

Magnetic bitholder

With permanent magnet. Safety locking by permanent magnet and positive locking. Easy removal by actuating the ejection.

Bitadapter

Met permanente magneet. Bit blijft op zijn plek dankzij permanente magneet en minimale speling tussen bit en bithouder. Eenvoudig uitnemen van de bit door uitwerpmecanisme.

Adaptateur magnétique pour embouts

Aimant permanent. Verrouillage de sécurité par l'aimant permanent et verrouillage positif. Démontage facile par opération d'éjection.

Adaptador de puntas

Con imán permanente. Bloqueo de seguridad mediante imán permanente y sujeción precisa. Fácil extracción por expulsor.



Chrom-Molybdän, verchromt. Mit ergonomischem 2-K Griff. Chrom-molybdenum, chromium. With ergonomic 2 components handle.

Extrem schmale Ausführung. Ideal geeignet für enge, schwer zugängliche Stellen. Extremely slim shape. Best suited for tight places with difficult access.

Bestell-No./Order-No.	Art. No.	CL Ø mm	g	mm	€
<b>50833010080</b>	5083301-1	200	240	1	<b>12,50</b>

### 50850-1601

Bit Adapter, Vierkantantrieb

Chrom-Vanadium-Stahl, Ausführung verchromt mit Haltekugel.

Bit adapter, square drive

Chrome vanadium steel, chrome-plated finish with retaining ball.

Bit adapter, vierkant-aansluiting

Chroom-Vanadium, verchromd, met kogel.

Porte-embouts

Avec entraînement carré, chrome vanadium, finition chromée, avec bille de blocage.

Adaptador de broca, cuadrado

Acero cromo vanadio, acabado cromado con bola de retención.



Sechskantantrieb für die Aufnahme von handelsüblichen Bits. Mit diesem Adapter können 1/4" Sechskant Bits mit Akkuschauber mit 1/2" Vierkantantrieb betätigt werden. Besonders geeignet für Trockenbauer, Zimmermann, Dachdecker und Gartenlandschaftsbau.

Hexagonal drive for accepting commercially available bits. With this adapter, 1/4" hexagon bits can be operated with cordless screwdrivers with 1/2" square drive. Particularly suitable for drywallers, carpenters, roofers and garden landscaping.

Bestell-No./Order-No.	○MM	■	CL Ø mm	g	mm	€
<b>50850160183</b>	1/4" (6,3 mm)	1/2" (12,5 mm)	38,12	60	10	<b>4,50</b>



**EINSÄTZE MIT SCHON-PROFIL  
UND KREUZRÄNDELUNG**

Super-Oberflächen-Verarbeitung, Oberfläche in Matt-Finish. Mehr Grip durch Kreuzrändelung. Schon-Profil schützt Schrauben und Muttern.

**SOCKETS WITH SP-PROFILE  
AND CROSS KNURLING**

Superior surface appearance in mat chromium plated finish. Cross knurling provides better grip and SP profile protects screws and nuts.



### 50825-71 – 50825-37

Chrom-Vanadium, verchromt  
 Halterung mit Sicherungssperre  
 Chrome-Vanadium, chromium plated  
 Holder with safety lock  
 Chrom-Vanadium, verchromt  
 Houder met vergrendeling  
 Chrome-Vanadium, chromées  
 Rack avec blocage  
 Cromo Vanadio, cromadas  
 Soporte con cierre de seguridad



NEW +

### 50825710083

13-tlg./pcs./-dlg./pces./pzs.

#### Satz mit Steckschlüssel-einsätzen

Socket set  
 Dopsleutelset  
 Composition de douilles  
 Conjunto de llaves de vaso



Steckschlüsseleinsätze mit Schonprofil und Kreuzrändelung.  
 Sockets with profile saver and cross knurling.



Entriegelung der Sicherungssperre durch einfaches Abknipsen des überstehenden Hakens.  
 Unlocking the holder through removing the protruding hook.

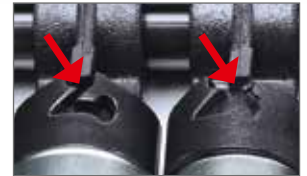

Links: Verriegelte Sicherungssperre  
 Rechts: Entsicherte Sperre  
 Left: locked  
 Right: unlocked

### 50825713783

8-tlg./pcs./-dlg./pces./pzs.

#### Satz mit Schraubendreher-einsätzen

Screwdriver socket set  
 Schroevendraaier dopsleutelset  
 Composition de douilles tournevis  
 Conjunto de llaves de vaso con destornillador



NEW +

Bestell-No./Order-No.	MM	Maße - Dimensions	g		€
50825710083	4/4,5/5/5,5/6/7/8/9/10/11/12/13/14	280 x 75 mm	300	1	21,70

### 50825711983

9-tlg./pcs./-dlg./pces./pzs.

#### Satz mit Steckschlüssel-einsätzen, extra lang

Socket set, extra long  
 Dopsleutelset, verlengd  
 Composition de douilles, extra longues  
 Conjunto de llaves de vaso, extra-largas



NEW +

Bestell-No./Order-No.		Maße - Dimensions	g		€
50825713783	TT 8/10/15/20/25/27/30/40	230 x 80 mm	180	1	20,25

### 50825719983

13-tlg./pcs./-dlg./pces./pzs.

#### Satz mit Schraubendreher-einsätzen

Screwdriver socket set  
 Schroevendraaier dopsleutelset  
 Composition de douilles tournevis  
 Conjunto de llaves de vaso con destornillador



NEW +

Bestell-No./Order-No.	MM	Maße - Dimensions	g		€
50825711983	6/7/8/9/10/11/12/13/14	230 x 100 mm	420	1	23,55



NEW +

Bestell-No./Order-No.		Maße - Dimensions	g		€
50825719983	⌀ 4/5,5/7 mm    ⬡ 3/4/5/6 mm ✦ 1/2    ⚙ TT 15/20/25/30	280 x 80 mm	280	1	26,55



1/4"

### 50833-2

#### Bit-Box-Satz, 32-tlg.

Chrom-Vanadium, gezandstraalt, mit magnetischem Schnellwechseladapter und Adapter für 1/4" Vierkant-Halter, mit formschlüssiger Arretierung, mit Gürtelhalter und Bohrung für Wandaufhängung.

#### Bit-box-set, 32 pcs.

Chrome-Vanadium, sand blasted, with magnetic quick changing adapter for 1/4" tool-holder with belt clip and borehole for wallmounting.

#### Bitbox set, 32-dlg.

Chroom-Vanadium, gezandstraalt, met magnetische snelwisseladapter en adapter voor 1/4" vierkant aansluiting, met broekriemclip en ophangoog voor wandbevestiging.

#### Jeu d'embouts de 32 pcs.

Chrome-Vanadium, sablé, avec adaptateur magnétique à éjection rapide, et adaptateur pour porte-outil 1/4" carré avec clip pour ceinture, brochable.

#### Juego de 32 puntas en caja

Cromo Vanadio, granulado, con adaptador imantado de cambio rápido, sujeción de cinturón y agujero para colgar de la pared.



■ R1/R2

○ 3,5/4,5/5,5/6,5/8

✚ PH1/PH2(2x)/PH3

✚ PZ1/PZ2(2x)/PZ3

⬡ 2/3/4/5/6/7/8

⚙ TT9/10/15/20/25/27/30/40

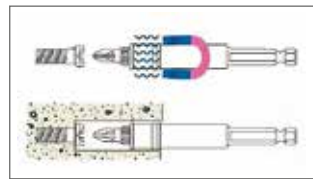

Bestell-No./Order-No.	Art. No.	Maße · Dimensions	⚖	📦	€
<b>50833200000</b>	50833-2	105 x 65 x 40 mm	250	1	<b>25,25</b>
* <b>50833201000</b>	50833-2-10	105 x 65 x 40 mm	2500	10	<b>224,95</b>

\*Lieferung im Verkaufsdisplay • Delivery in sale display

### 50833-3

#### Bit-Box-Satz, 31-tlg.

Bit-Knarre, 48 Zähne. Chrom-Vanadium, gezandstraalt, mit Adapter für 1/4" Vierkant-Halter, mit Gürtelhalter.

#### Bit-box-set, 31 pcs.

Bit-Ratchet, 48 teeth. Chrome-Vanadium, sand blasted, with adapter for 1/4" tool-holder with belt clip.

#### Bitbox, set 31-dlg.

Ratelbithouder 48 tanden. Chroom-Vanadium, gezandstraalt met Adapter voor 1/4" vierkant aansluiting, met broekriemclip.

#### Jeu d'embouts de 31 pcs.

Cliquet à embouts de 48 dents. Chrome vanadium, sablé, avec adaptateur 1/4" carré, clip de ceinture.

#### Juego de 31 puntas en caja

Bit-carraca, 48 dientes. Cromo Vanadio, granulado, con adaptador de cambio rápido, sujeción de cinturón.



■ R1/R2

○ 3,5/4,5/5,5/6,5/8

✚ PH1/PH2(2x)/PH3

✚ PZ1/PZ2(2x)/PZ3

⬡ 2/3/4/5/6/7/8

⚙ TT9/10/15/20/25/27/30/40

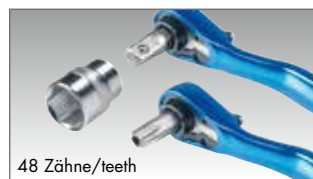

48 Zähne/teeth

Bestell-No./Order-No.	Art. No.	Maße · Dimensions	⚖	📦	€
* <b>50833300000</b>	50833-3	105 x 65 x 40 mm	358	1	<b>34,00</b>

\*Auslauf / Discontinued



**50833-4**

**Bit-Box-Satz, 33-tlg.**

Chrom-Vanadium, gesandstrahlt, mit Adapter für 1/4" Sechskant-Halter, mit Gürtelhalter.

Bit-box-set, 33 pcs.

Chrome-Vanadium, sand blasted, with adapter for 1/4" tool-holder with belt clip.

Bitbox, set 33-dlg.

Chroom-Vanadium, gezandstraalt, met Adapter voor 1/4" sechskant aansluiting, met broekriemclip.

Jeu d'embouts de 33 pcs.

Chrome vanadium, sablé, avec adaptateur 1/4" carré, clip de ceinture.

Juego de 33 puntas en caja

Cromo Vanadio, granallado, con adaptador de cambio rápido, sujeción de cinturón.



- 3/4/5/5,5/6,5
- PH1/PH2(2x)/PH3
- PZ1/PZ2(2x)/PZ3
- 2/2,5/3/4/5/6
- T8/9/10/15(2x)/20(2x)/25(2x)/27/30/40

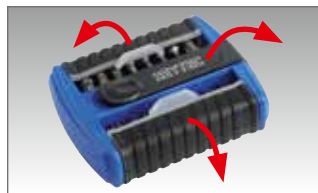

Bestell-No./Order-No.	Art. No.	Maße - Dimensions			€
* <b>50833400000</b>	50833-4	105 x 85 x 45 mm	295	1	<b>27,10</b>
* <b>50833401200</b>	50833-4-12	105 x 85 x 45 mm	3540	12	<b>294,70</b>

\*Lieferung im Verkaufsdisplay • Delivery in sale display  
\* Auslauf / Discontinued

**50833-5**

**Bit-Box-Satz, 32-tlg.**

Chrom-Vanadium, gesandstrahlt, Mini-Bit-Knarre, 48 Zähne, magnetischer Schnellwechseladapter mit Arretierung, mit Gürtelhalter.

Bit-box-set, 32 pcs.

Chrome-Vanadium, sand blasted, Mini-Bit-Ratchet, 48 teeth, magnetic quick changing adapter, with belt clip.

Bitbox, set 32-dlg.

Chroom Vanadium, gezandstraald, mini bit ratel, 48 tands, magnetische snelwisseladapter, met riemhouder.

Jeu d'embouts de 32 pcs.

Chrome Vanadium, sablé, mini cliquet porte-embouts, 48 dents, adaptateur quick change magnétique, avec clip de ceinture.

Juego de 32 puntas en caja

Cromo-Vanadio, granallado, mini carraca, 48 dientes, adaptador imantado de cambio rápido con clip de cinturón.



- enthaltend/containing
- 85 mm
  - 95 mm
  - 3,5/4,5/5,5/6,5/8
  - PH1(2x)/PH2(2x)/PH3
  - PZ1/PZ2(2x)/PZ3
  - 2/3/4/5/6/7/8
  - TT9/10/15/20/25/27/30/40



Bestell-No./Order-No.	Art. No.	Maße - Dimensions			€
<b>50833500000</b>	50833-5	105 x 65 x 40 mm	300	1	<b>39,40</b>
* <b>50833501000</b>		105 x 65 x 40 mm	3580	10	<b>358,85</b>

\*Lieferung im Verkaufsdisplay • Delivery in sale display

1/4"

## 9083312-3

### Adapter-Satz, 3-tlg.

Chrom-Vanadium-Stahl, gesandstrahlt, 1/2", 3/8", 1/4", Vierkant mit Kugelarretierung, 1/4" (6,3 mm) Sechskant Antrieb für Bohrmaschine und Akkuschrauber.

### Adapter-set, 3 pcs.

Chrome-Vanadium steel, sand blasted, 1/2", 3/8", 1/4" square drive with ball stop, 1/4" (6.3 mm) hexagon drive for electric powered tools.

### Adapterset, 3-dlg.

Chroom-vanadium, gezandstraalt, 1/2", 3/8", 1/4", vierkant met kogelvergrendeling, voor boormachine en accu-schroevendraaier, 1/4" (6,3 mm) zeskant aansluiting.

### Jeu d'adaptateurs, 3 pcs

En Chrome Vanadium. 1/2", 3/8", 1/4", avec bille de blocage, pour perceuses et visseuses électriques, entraînement hexagonal 1/4" (6,3 mm).

### Juego de 3 adaptadores

Acero al cromo vanadio, granulado de 1/2", 3/8", 1/4". Cuadradillo con bola de fijación de bola para taladros y atornilladores inalámbricos, punta hexagonal de 1/4" (6,3 mm).

1/4"



1/4"

3/8"

1/2"



Bestell-No./Order-No.	■	CLD mm	⚖️	⚖️	📦	€
<b>90833120305</b>	1/4"	64	21	100	10	<b>12,70</b>
	3/8"	64	32			
	1/2"	73	47			

## 50833-465

### Bit-Adapter

#### für Bohrmaschinen und Akkuschrauber

Chrom-Vanadium, verchromt, extra schlanke Ausführung mit magnetischer und formschlüssiger Arretierung. Für enge Bauräume.

### Bit-Adapter

#### for drilling machines and cordless screwdrivers

Chrome-Vanadium, chromium plated, extra slim version with magnetic, form-fit locking. For tight installation spaces.

### Bit adapter

#### voor boor- en accuboormachines

Chroom-Vanadium, verchromd, extra slanke uitvoering met magnetische en vormvaste vergrendeling. Ideaal voor krappe bouwruimtes. Ideaal voor krappe bouwruimtes.

### Porte-embouts tournevis

#### pour perceuses et visseuses

Chrome-Vanadium, chromées, exécution extra mince avec blocage magnétique. Idéal pour les petits espaces.

### Adaptador para puntas en taladros

#### y destornilladores eléctricos

Acero al cromo-vanadio, cromado, diseño extra delgado, con sujeción imantada. Ideal para trabajo en espacios reducidos.

1/4"

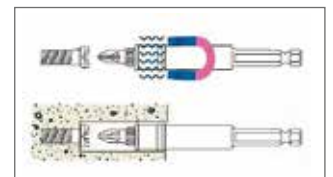

Bestell-No./Order-No.	Art. No.	CLD mm	⤴	⚖️	📦	€
<b>50833046500</b>	50833-465	95	250 g	71	1	<b>6,35</b>



**50825-3015**

44-tlg./pcs./-dlg./pces./pzs.

**Steckschlüsselgarnitur**

Chrom-Vanadium, verchromt, in Kunststoffkoffer.

**Socket set**

Chrome-Vanadium, chromium plated, in plastic box.

**Dopsleutelset**

Chroom-Vanadium, verchromd, in kunststof koffer.

**Composition de douilles**

Chrome-Vanadium, chromé, en coffret plastique.

**Conjunto de llaves de vaso**

Cromo Vanadio, cromadas, en caja de plástico.



enthaltend/containing	
	150 mm
	150 mm
	MM 4/4,5/5/5,5/6/7/8/9/10/11/12/13
	MM 6/7/8/9/10/11/12/13
	50 / 100 mm
	37 mm
	M 5/6/8
	PH 1/2/3
	3/4/5/6
	4/5,5
	TT 10/15/20/25/27/30/40

Bestell.-No./Order-No.	Art. No.	Maße - Dimensions			€
<b>50825301583</b>	50825-3015	280 x 220 x 60 mm	1600	1	<b>115,00</b>

**50828-3015**

29-tlg./pcs./-dlg./pces./pzs.

**T-Griff Steckschlüssel-Garnitur**

Chrom-Vanadium, verchromt, mit 2-K Schaumstoffeinlage in Metallkasten.

**T-Handle socket set**

Chrome-Vanadium, chromium plated, with 2 components foam insert in metal case.

**Dopsleutelset, T-greep met ratelfunctie**

Chroom-Vanadium, verchromd, met 2 componenten schuimleg in metalen koffer.

**Composition de douilles avec manche-T**

Chrome-Vanadium, chromées, avec plateau mousse bicolore, en coffret métallique.

**Juego de llaves de tubo con mango en T**

Cromo Vanadio, cromadas, con material de espuma 2 componentes alta gama en caja metálica.



enthaltend/containing	
	115 mm
	MM 4/4,5/5/5,5/6/7/8/9/10/11/12/13
	100 / 250 mm
	37 mm
	PZ 1/2
	3/4/5/6
	4/5,5
	TT 15/20/25/27/30/40



Bestell.-No./Order-No.	Art. No.	Maße - Dimensions			€
<b>50828301583</b>	50828-3015	407 x 162 x 52 mm	1860	1	<b>125,95</b>

1/4"

### 50829-3016

45-tlg./pcs./-dlg./pces./pzs.

#### Steckschlüsselgarnitur

Chrom-Vanadium, verchromt, mit 2-K Schaumstoffeinlage in Metallkasten.

#### Socket set

Chrome-Vanadium, chromium plated, with 2 components foam insert in metal case.

#### Dopsleutelset

Chroom-Vanadium, verchromd, met 2 componenten schuimvleg in metalen koffer.

#### Composition de douilles

Chrome-Vanadium, chromées, avec intérieur mousse à 2 composantes en coffret métallique.

#### Conjunto de llaves de vaso

Cromo Vanadio, cromadas, con material de espuma 2 componentes alta gama en caja metálica.

1/4" SP

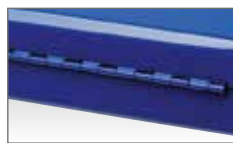

Bestell-No./Order-No.	Art. No.	Maße · Dimensions			€
<b>50829301683</b>	50829-3016	320 x 140 x 55 mm	2180	1	<b>115,00</b>

enthaltend/containing	
	150 mm
	115 mm
	150 mm
	37 mm
	50 mm
	MM 4/4,5/5/5,5/6/7/8/9/10/11/12/13/14
	PZ 1/2/3
	PH 1/2/3
	3/4/5/6
	4/5/5/7
	TT 8/10/15/20/25/27/30/40
	E 4/5/6/7/8/10

### 50829-3017

22-tlg./pcs./-dlg./pces./pzs.

#### Steckschlüssel- und Bitsgarnitur

Chrom-Vanadium, verchromt, in Kunststoffkoffer.

#### Socket- and bit-set

Chrome-Vanadium, chromium plated, in plastic box.

#### Dopsleutel- en bitset

Chroom-Vanadium, verchromd, in kunststof koffer.

#### Composition de douilles et embouts

Chrome-Vanadium, chromées, en coffret plastique.

#### Conjunto de llaves de vaso y bits

Cromo Vanadio, cromadas, en caja de plástico.

1/4"

1/4"

SP

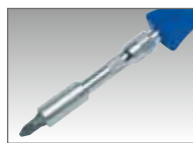

enthaltend/containing	
	140 mm
	MM 5/6/7/8/10/11/12/13
	50 mm
	50 mm
	25 mm
	100 mm
	PH 1/2
	4/5,5
	TT 10/15/20/25/27

Bestell-No./Order-No.	Art. No.	Maße · Dimensions			€
<b>50829301783</b>	50829-3017	160 x 102 x 36 mm	575	1	<b>89,20</b>

Mit arretierbarer Gelenkknarre + Gürtelclip.  
With articulated lockable ratchet plus belt clip.

### 50829-3019

25-tlg./pcs./-dlg./pces./pzs.

#### Steckschlüsselgarnitur

Chrom-Vanadium, verchromt, mit 2-K Schaumstoffeinlage in Kunststoffbox.

#### Socket set

Chrome-Vanadium, chromium plated, with 2 components foam insert in plastic box.

#### Dopsleutelset

Chroom-Vanadium, verchromd, met 2 componenten schuimvleg in kunststof koffer.

#### Composition de douilles

Chrome-Vanadium, chromées, avec intérieur mousse à 2 composantes en coffret plastique.

#### Conjunto de llaves de vaso

Cromo Vanadio, cromadas, con material de espuma 2 componentes alta gama en caja de plástico.

1/4"

1/4"

SP



enthaltend/containing	
	MM 4/4,5/5/5,5/6/7/8/9/10/11/12/13
	115 mm
	100 mm
	1/4"
	PZ 2
	PH 2
	5/6
	TT 10/15/20/25/30/40

Bestell-No./Order-No.	Art. No.	Maße · Dimensions			€
<b>50829301983</b>	50829-3019	145 x 102 x 50 mm	775	1	<b>49,15</b>





### 50829-3018

44-tlg./pcs./-dlg./pces./pzs.

#### Steckschlüssel- und Bitsgarnitur

Chrom-Vanadium, verchromt, mit 2-K Schaumstoffeinlage in Kunststoffbox.

#### Socket- and bit-set

Chrome-Vanadium, chromium plated, with 2 components foam insert in plastic box.

#### Dopsleutel- en bitset

Chroom-Vanadium, verchromd, met 2 componenten schuimleg in kunststof koffer.

#### Composition de douilles et embouts

Chrome-Vanadium, chromées, avec intérieur mousse à 2 composantes, en coffret plastique.

#### Conjunto de llaves de vaso y bits

Cromo Vanadio, cromadas, con material de espuma 2 componentes alta gama en caja de plástico.



enthaltend/containing	
	115 mm
	MM 6 - 13
	50 mm
	1/4"
	100 mm
	110 mm
	85 mm
	PZ 1/2/2/3/4
	PH 1/2/2/3
	2/3/4/5/6/7/8
	3,5/4,5/5,5/6,5
	TT 7/8/9/10/15/20/25/27/30/40

Bestell-No./Order-No.	Art. No.	Maße · Dimensions			€
<b>50829301883</b>	50829-3018	145 x 102 x 50 mm	765	1	<b>112,20</b>

### 50829-3020

46-tlg./pcs./-dlg./pces./pzs.

#### Steckschlüssel- und Bitsgarnitur

Hochwertiger Chrom-Vanadium Stahl DIN 3123 B · ISO 3316. Einsätze mit Schraubenschonprofil. Adapter für 1/4" Bits. Top Finish. Ergonomischer Softgriff. Hochwertiger 2-Komponenten Schaumstoff. In Kunststoffbox.

#### Socket- and bit-set

High grade chrome vanadium steel DIN 3123 B · ISO 3316. Profile saver sockets. Adapter for 1/4" bits. Top Finish. Ergonomically designed soft grip handle. High grade 2 components foam material. In plastic box.

#### Dopsleutel- en bitset

Hoogwaardig chroom-vanadium staal DIN 3123 B · ISO 3316. Dopsleutels met profiel-bescherming. Adapter voor 1/4" bits. Top Finish. Ergonomische soft grip. Hoogwaardig 2-comp. schuimstof, in kunststof koffer.

#### Composition de douilles et embouts

Chrome vanadium de haute qualité. Acier DIN 3123 B · ISO 3316. Adaptateur pour 1/4" embouts. Finition supérieure. Soft grip ergonomique. Matériel mousse 2 composants de haute qualité. Boîte plastique.

#### Conjunto de llaves de vaso y bits

Acero al cromo vanadio de gran calidad, acero DIN 3123 B · ISO 3316. Llaves de vaso con perfil especial. Adaptador para bits de 1/4". Acabado óptimo. Mango ergonómico. Plástico expandido de 2 componentes de alta calidad. En estuche de plástico.



enthaltend/containing	
	115 mm
	100 mm
	65 mm
	MM 4/4,5/5,5/6/7/8/9/10/11/12/13
	25 mm
	2/3/4/5/6/7/8
	PH 1/2/2/3
	PZ 1/2/2/3/4
	3,5/4,5/5,5/6,5
	TT 7/8/9/10/15/20/25/27/30/40

Hebelumschaltknarre, mit Auswerferstift zum Schnellösen der Steckverbindung, 48 Zähne.  
Lever type reversible ratchet, with quick release ejector button, 48 teeth.



Bestell-No./Order-No.	Art. No.	Maße · Dimensions			€
<b>50829302083</b>	50829-3020	145 x 105 x 50 mm	700	1	<b>74,40</b>



Chrom-Vanadium, verchromt  
 Chrome-Vanadium, chromium plated

### Hebelumschaltknarre

Lever type reversible ratchet  
 Omschakelbare ratel  
 Cliquets réversibles  
 Carraca reversible

#### 50840-00-15

DIN 3122 D · ISO 3315

48 Zähne/teeth/tanden/dents/dientes

Mit Auswerferstift zum Schnellösen der Steckverbindung. Mit ergonomischem 2-K Griff.

With quick release ejector button. With ergonomic 2 components handle.

Met pal, met ontgrendelstift. Met ergonomische 2 componenten greep.

Tige d'éjection pour libérer rapidement l'outil du cliquet. Avec poignée ergonomique bimatière.

Con expulsor para separación instantánea de vasos y accesorios. Con mango ergonómico de dos componentes.



Bestell-No./Order-No.	Art. No.		$\varnothing$ mm			€
<b>50840015083</b>	50840-00-15	3/8"	200	285	5	<b>34,20</b>

#### 50840-10-17

60 Zähne/teeth/tanden/dents/dientes

Mit Auswerferstift zum Schnellösen der Steckverbindung. Mit ergonomischem 2-K Griff. 30% mehr Drehmoment durch innovative Sperrfunktion.

With quick release ejector button. With ergonomic 2 components handle. Innovative locking function for 30% higher torque.

Met pal, met ontgrendelstift. Met ergonomische 2 componenten greep. 30% meer draaimoment door innovatieve blokkeerfunctie.

Tige d'éjection pour libérer rapidement l'outil du cliquet. Avec poignée ergonomique bimatière. 30% plus de couple grâce à la fonction de blocage innovante.

Con expulsor para separación instantánea de vasos y accesorios. Con mango ergonómico de dos componentes. Par de apriete aumentado en un 30% gracias a la función de bloqueo innovador.

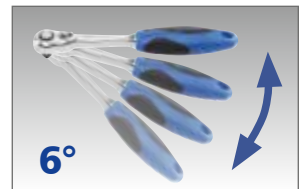

Extrem schlank, bestens geeignet für enge Bauräume.  
 Extremely slim, best suited for places of hard access.



Bestell-No./Order-No.	Art. No.		$\varnothing$ mm			€
<b>50840101783</b>	50840-10-17	3/8"	205	280	5	<b>34,20</b>



### 50840-03

DIN 3122 A · ISO 3315

Griff mit Gleitstück  
Sliding Thandle  
Greep met schuifstuk  
Poignée coulissante  
Mango corredizo



Bestell-No./Order-No.	Art. No.		CLD mm			€
<b>50840030083</b>	50840-03	3/8"	150	205	10	<b>11,60</b>

### 50840-04-1/04

DIN 3123 B · ISO 3316

Verlängerungen  
Extension bars  
Verlengstukken  
Rallonges  
Alargaderas



50840-04-1



50840-04

Bestell-No./Order-No.	Art. No.		CLD mm			€
<b>50840041083</b>	50840-04-1	3/8"	75	75	10	<b>3,00</b>
<b>50840040083</b>	50840-04	3/8"	150	140	10	<b>4,50</b>

### 50840-06

DIN 3123 C · ISO 3316

Kardangelen  
Universal joint  
Kardangewricht  
Cardan universel  
Articulaciones universales



Bestell-No./Order-No.	Art. No.		CLD mm			€
<b>50840060083</b>	50840-06	3/8"	55	65	10	<b>8,65</b>

### 50840-14/50840-15

DIN 3123 A · ISO 3316

Adapter  
Converter  
Adapter  
Réducteur  
Reductor



Bestell-No./Order-No.	Art. No.			CLD mm			€
<b>50840140083</b>	50840-14	3/8"	1/4"	25	68	10	<b>3,95</b>
<b>50840150083</b>	50840-15	3/8"	1/2"	45	70	10	<b>4,80</b>

### 50850-14-1

DIN 3123 A · ISO 3316

Gleitstück für Verlängerung  
Sliding Thread / Adapter  
Schuifstuk voor verlengstuk  
Coulisseau à adapter  
Conexión corrediza para adaptador



Bestell-No./Order-No.	Art. No.			CLD mm			€
<b>50850141083</b>	50850-14-1	1/2"	3/8"	40	70	10	<b>4,50</b>

### 50840-14/50840-15

DIN 3123 A · ISO 3316

Adapter  
Converter  
Adapter  
Réducteur  
Reductor



Bestell-No./Order-No.	Art. No.			CLD mm			€
<b>50840140183</b>	50840-1401	3/8"	1/4"	25	19	10	<b>2,75</b>



**50840-1501**  
DIN 3123 A · ISO 3316

Adapter

Converter

Adapter

Augmentateur

Reductor

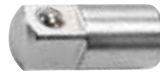

Bestell-No./Order-No.	Art. No.	■	□	CL mm	g	mm	€
<b>50840150183</b>	50840-1501	1/2"	3/8"	35	43	10	<b>4,20</b>

**50840-6**  
DIN 3124 / ISO 2725

Steckschlüsseinsätze,  
sechskant

Chrom-Vanadium, verchromt

Sockets, hexagon

Chrome-Vanadium, chromium plated

Dopsleutels, zeskant

Chroom-Vanadium, verchromd

Douilles, 6 pans

Chrome-Vanadium, chromées

Llaves de vaso, boca hexagonal

Cromo Vanadio, cromadas



Bestell-No./Order-No.	MM	CL mm	T mm	D1 mm	D2 mm	g	mm	€
<b>50840600883</b>	8	25,5	10,0	12,5	12,0	20	10	<b>1,85</b>
<b>50840600983</b>	9	28,0	10,0	17,0	13,0	22	10	<b>1,85</b>
<b>50840601083</b>	10	28,0	12,0	14,5	17,0	23	10	<b>1,85</b>
<b>50840601183</b>	11	25,5	12,0	15,5	17,0	24	10	<b>1,85</b>
<b>50840601283</b>	12	25,5	10,0	17,0	17,0	25	10	<b>1,85</b>
<b>50840601383</b>	13	25,5	11,0	18,5	17,0	26	10	<b>1,85</b>
<b>50840601483</b>	14	25,5	15,0	20,0	18,0	30	10	<b>2,20</b>
<b>50840601583</b>	15	25,5	15,0	21,0	19,5	33	10	<b>2,20</b>
<b>50840601683</b>	16	25,5	16,0	22,0	19,5	34	10	<b>2,50</b>
<b>50840601783</b>	17	25,5	17,0	23,0	20,0	35	10	<b>2,50</b>
<b>50840601883</b>	18	26,0	17,0	24,5	21,0	40	10	<b>2,75</b>
<b>50840601983</b>	19	26,5	17,0	26,0	23,0	46	10	<b>2,75</b>
<b>50840602083</b>	20	32,0	18,0	27,0	24,0	68	10	<b>3,05</b>
<b>50840602183</b>	21	32,0	18,0	28,0	25,0	70	10	<b>3,05</b>
<b>50840602283</b>	22	32,0	18,0	29,5	26,5	82	10	<b>3,05</b>
<b>50840602483</b>	24	32,0	18,0	32,0	28,0	95	10	<b>3,80</b>

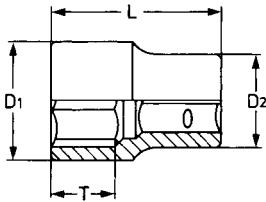

**50840-19-1/50840-19-3**  
DIN 3124 / ISO 2725

Zündkerzeneinsätze

Chrom-Vanadium, verchromt  
mit Gummisicherung

Spark plug sockets

Chrome-Vanadium, chromium plated  
with rubber insert

Bougiedopsleutel

Chroom-Vanadium, verchromd  
met rubber inleg

Douilles pour bougies

Chrome-Vanadium, chromées  
avec bague de caoutchouc

Llaves de vaso, para bujías

Cromo Vanadio, cromadas  
con injerto de goma



Bestell-No./Order-No.	MM	CL mm	T mm	D mm	MM	g	mm	€
<b>50840190183</b>	20,8	70,0	25,0	27,0	24	160	10	<b>4,80</b>
<b>50840190383</b>	16	65,0	20,0	22,5	19	100	10	<b>3,85</b>

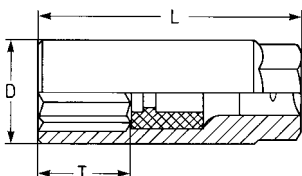



### 50840-3015

23-tlg./pcs./-dlg./pces./pzs.

#### Steckschlüsselgarnitur

Chrom-Vanadium, verchromt,  
in Kunststoffkoffer.

#### Socket set

Chrome-Vanadium, chromium plated,  
in plastic box.

#### Dopsleutelset

Chroom-Vanadium, verchromd,  
in kunststof koffer.

#### Composition de douilles

Chrome-Vanadium, chromées,  
en coffret plastique.

#### Conjunto de llaves de vaso

Cromo Vanadio, cromadas,  
en caja de plástico.



#### enthaltend/containing

	200 mm
	MM 8/9/10/11/12/ 13/14/15/16/ 17/18/19/20/21/22/24
	MM 16/20,8
	150 mm
	75 mm
	55 mm

Bestell.No./Order-No.	Art. No.	Maße - Dimensions			€
<b>50840301583</b>	50840-3015	280 x 220 x 60 mm	2000	1	<b>118,90</b>

### 50842-3015

15-tlg./pcs./-dlg./pces./pzs.

#### Steckschlüsselgarnitur

Chrom-Vanadium, verchromt,  
in Metallkasten.

#### Socket set

Chrome-Vanadium, chromium plated,  
in metal case.

#### Dopsleutelset

Chroom-Vanadium, verchromd,  
in metalen koffer.

#### Composition de douilles

Chrome-Vanadium, chromées,  
en coffret métallique.

#### Conjunto de llaves de vaso

Cromo Vanadio, cromadas,  
en caja metálica.



#### enthaltend/containing

	MM 8/10/12/13/14/15/ 17/19/21/22/24
	200 mm
	75 / 150 mm
	55 mm

Bestell.No./Order-No.	Art. No.	Maße - Dimensions			€
<b>50842301583</b>	50842-3015	250 x 150 x 40 mm	1650	1	<b>87,90</b>



Chrom-Vanadium, verchromt  
 Chrome-Vanadium, chromium plated  
 Chroom-Vanadium, verchroomd  
 Chrome-Vanadium, chromées  
 Cromo Vanadio, cromadas

### Durchstecknarre

Ratchet  
 Doorsteekratel  
 Cliquet  
 Carraca



### 50750-01 DIN 3122 C

Mit Verbindungsvierkant, 2-tlg.  
 With square coupler, 2 pcs.  
 Met verbindingsvierkant, 2 dlg.  
 Avec carré conducteur, 2 pcs.  
 Pasante de acoplamiento cuadrado 2 pzs.



Bestell-No./Order-No.	Art. No.			mm			€
<b>50750010080</b>	50750-01	1/2"		260	490	5	<b>32,75</b>

### 50750-01-1 DIN 3122 C

Ohne Verbindungsvierkant  
 Without square coupler  
 Zonder verbindingsvierkant  
 Sans carré conducteur  
 Sin cuadradillo



Bestell-No./Order-No.	Art. No.		mm			€
<b>50750010180</b>	50750-01-1		260	430	5	<b>27,75</b>

### 90050-16 DIN 3122 CV · ISO 3315

Verbindungsvierkant  
 für 1/2" Verbindungen

Square coupler  
 plated, for 1/2" connections

Verbindingsvierkant  
 voor 1/2" hulpstukken

Carré conducteur  
 pour 1/2" connexions

Adaptador  
 para 1/2" conexions



Bestell-No./Order-No.	Art. No.		mm			€
<b>90050160083</b>	90050-16	1/2"	37	45	10	<b>5,20</b>

## Hebelumschaltknarre

Lever type reversible ratchet

Omschakelbare ratel

Cliquets réversibles

Carraca reversible

### 50850-00-15

DIN 3122 D · ISO 3315

48 Zähne/teeth/tanden/dents/dientes

Mit Auswerferstift zum Schnelllösen der Steckverbindung. Mit ergonomischem 2-K Griff.

With quick release ejector button. With ergonomic 2 components handle.

Met ontgrendelstift. Met ergonomische 2 componenten greep.

Tige d'éjection pour libérer rapidement l'outil du cliquet. Avec poignée ergonomique bimatière.

Con expulsor para separación instantánea de vasos y accesorios. Con mango ergonómico de dos componentes.



Bestell-No./Order-No.	Art. No.		CL mm			€
<b>50850015083</b>	50850-00-15	1/2"	250	555	5	<b>41,40</b>

### 50850-10-16

72 Zähne/teeth/tanden/dents/dientes

Mit Auswerferstift zum Schnelllösen der Steckverbindung. Gebogener Stahlkern.

With quick release ejector button. Offset handle.

Met ontgrendelstift. Gebogen stalen kern.

Tige d'éjection pour libérer rapidement l'outil du cliquet. Poignée courbée en acier.

Con expulsor para separación instantánea de vasos y accesorios. Mango acodado.



Bestell-No./Order-No.	Art. No.		CL mm			€
<b>50850101680</b>	50850-10-16	1/2"	255	510	5	<b>45,25</b>

### 50850-10-17

60 Zähne/teeth/tanden/dents/dientes

Mit Auswerferstift zum Schnelllösen der Steckverbindung. Mit ergonomischem 2-K Griff. 30% mehr Drehmoment durch innovative Sperrfunktion.

With quick release ejector button. With ergonomic 2 components handle. Innovative locking function for 30% higher torque.

Met ontgrendelstift. Met ergonomische 2 componenten greep. 30% meer draaimoment door innovatieve blokkeerfunctie.

Tige d'éjection pour libérer rapidement l'outil du cliquet. Avec poignée ergonomique bimatière. 30% plus de couple grâce à la fonction de blocage innovante.

Con expulsor para separación instantánea de vasos y accesorios. Con mango ergonómico de dos componentes. Par de apriete aumentado en un 30% gracias a la función de bloqueo innovador.

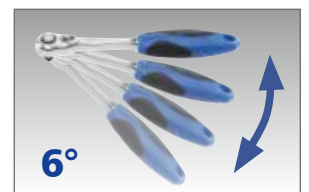

Extrem schlank, bestens geeignet für enge Bauräume.  
Extremely slim, best suited for places of hard access.



Bestell-No./Order-No.	Art. No.		CL mm			€
<b>50850101783</b>	50850-10-17	1/2"	260	555	5	<b>43,95</b>

1/2"

**50850-03**

DIN 3122 A · ISO 3315

Griff mit Gleitstück  
Sliding Thandle  
Greep met schuifstuk  
Poignée coulissante  
Mango corredizo



Bestell-No./Order-No.	Art. No.		Ø mm			€
<b>50850030083</b>	50850-03	1/2"	250	500	10	<b>15,20</b>

**50850-04/05**

DIN 3123 B · ISO 3316

Verlängerungen  
Extension bars  
Verlengstukken  
Rallonges  
Alargaderas



50850-04





50850-05



50850-05-54



50850-05-55

Bestell-No./Order-No.	Art. No.		Ø mm			€
<b>50850040083</b>	50850-04	1/2"	125	200	10	<b>6,95</b>
<b>50850050083</b>	50850-05	1/2"	250	420	10	<b>11,05</b>
<b>50850055483</b>	50850-05-54	1/2"	400	670	10	<b>28,35</b>
<b>50850055583</b>	50850-05-55	1/2"	500	850	5	<b>33,45</b>

**50850-04-5/05-5**

Schwenkbare  
Verlängerungen  
Wobble extension  
Zwenbare verlengstukken  
Rallonges articulée  
Alargaderas oscilante



50850-04-5



50850-05-5



Bestell-No./Order-No.	Art. No.		Ø mm			€
<b>50850045083</b>	50850-04-5	1/2"	125	200	10	<b>11,75</b>
<b>50850055083</b>	50850-05-5	1/2"	250	420	10	<b>18,00</b>



**1/2"****50850-06**

DIN 3123 C · ISO 3316

Kardangelen

Universal joint

Kardangewricht

Cardan universel

Articulaciones universales



Bestell-No./Order-No.	Art. No.		CLD mm			€
<b>50850060083</b>	50850-06	1/2"	75	150	10	<b>11,05</b>

**50850-14-1/50840-15**

DIN 3123 A · ISO 3316

Gleitstück für Verlängerung

Sliding Thread / Adapter

Schuifstuk voor verlengstuk

Coulisseau à adapter

Conexión corrediza para adaptador

**1/2"****3/8"**

50850-14-1

**3/8"****1/2"**

50840-15

Bestell-No./Order-No.	Art. No.			CLD mm			€
<b>50850141083</b>	50850-14-1	1/2"	3/8"	40	70	10	<b>4,50</b>
<b>50840150083</b>	50840-15	3/8"	1/2"	45	70	10	<b>4,80</b>

**50850-1401**

DIN 3123 A · ISO 3316

Adapter

Converter

Adapter

Réducteur

Reductor

**1/2"****3/8"**

Bestell-No./Order-No.	Art. No.			CLD mm			€
<b>50850140183</b>	50850-1401	3/8"	1/2"	35	46	10	<b>4,45</b>

**50850-1501**

DIN 3123 A · ISO 3316

Adapter

Converter

Adapter

Réducteur

Reductor

**1/2"****3/4"**

Bestell-No./Order-No.	Art. No.			CLD mm			€
<b>50850150183</b>	50850-1501	3/4"	1/2"	50	142	10	<b>7,95</b>

1/2"

**50850-6**  
DIN 3124 / ISO 2725

**Steckschlüsseinsätze, sechskant**

Chrom-Vanadium, verchromt

Sockets, hexagon

Chrome-Vanadium, chromium plated

Dopsleutels, zeskant

Chroom-Vanadium, verchromd

Douilles, 6 pans

Chrome-Vanadium, chromées

Llaves de vaso, boca hexagonal

Cromo Vanadio, cromadas

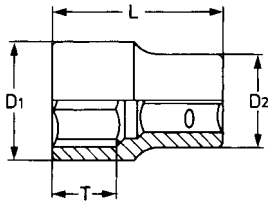

Bestell-No./Order-No.	ØMM	CLD mm	T mm	D1 mm	D2 mm	g	mm	€
50850600883	8	38,5	14,0	13,5	22,0	48	10	2,65
50850600983	9	38,5	14,0	14,5	22,0	48	10	2,65
50850601083	10	38,5	14,0	15,5	22,0	54	10	2,65
50850601183	11	38,5	14,0	16,5	22,0	51	10	2,65
50850601283	12	38,5	14,0	17,5	22,0	50	10	2,65
50850601383	13	38,5	14,0	18,5	22,0	50	10	2,65
50850601483	14	38,5	14,0	20,0	22,0	53	10	2,65
50850601583	15	38,5	14,0	21,5	22,0	55	10	3,05
50850601683	16	38,5	14,0	22,5	22,0	63	10	3,05
50850601783	17	38,5	14,0	24,0	22,5	66	10	3,05
50850601883	18	38,5	14,0	25,0	23,0	71	10	3,55
50850601983	19	38,5	20,0	25,0	24,5	74	10	3,55
50850602083	20	38,5	20,0	28,0	25,5	84	10	3,60
50850602183	21	38,5	20,0	28,0	26,5	84	10	3,60
50850602283	22	38,5	20,0	30,0	28,0	105	10	4,15
50850602383	23	40,0	20,0	32,0	28,0	116	10	4,15
50850602483	24	40,5	22,0	32,0	30,0	120	10	5,05
50850602783	27	42,5	22,0	36,0	34,0	170	10	6,15
50850603083	30	42,5	22,0	40,0	36,5	205	10	6,95
50850603283	32	45,0	25,0	42,0	38,0	235	10	7,45
50850603483	34	46,0	43,9	37,0	22,0	241	10	9,90
50850603683	36	46,0	47,9	37,8	22,0	274	10	11,95

**50850-6**  
DIN 3124 / ISO 2725

**AF-Größen**

Chrom-Vanadium, verchromt

AF-Sizes

Chrome-Vanadium, chromium plated

AF

Chroom-Vanadium, verchromd

AF

Chrome-Vanadium, chromées

AF

Cromo Vanadio, cromadas



Bestell-No./Order-No.	ØAF	CLD mm	T mm	D1 mm	D2 mm	g	mm	€
50850631983	3/8"	38,0	12,0	15,0	22,0	49	10	2,70
50850632183	7/16"	38,0	12,0	16,3	22,0	50	10	2,70
50850632383	1/2"	38,0	12,0	18,8	22,0	51	10	2,70
50850632583	9/16"	38,0	12,0	20,4	22,0	53	10	2,70
50850632783	5/8"	38,0	12,0	22,9	22,0	61	10	2,70
50850632983	11/16"	38,0	12,0	24,0	22,0	68	10	3,30
50850633183	3/4"	38,0	14,0	26,0	23,0	73	10	3,30
50850633383	13/16"	38,0	14,0	28,0	25,0	82	10	3,75
50850633483	7/8"	40,0	14,0	30,0	26,0	106	10	4,15
50850633583	15/16"	42,0	16,0	32,0	28,0	121	10	4,90
50850633783	1"	42,0	16,0	34,0	30,0	150	10	6,20
50850633883	1.1/16"	43,0	18,0	36,0	30,0	168	10	6,90
50850633983	1.1/8"	43,0	20,0	38,0	32,0	205	10	7,30
50850634083	1.3/16"	46,0	22,0	40,0	34,0	225	10	7,65
50850634183	1.1/4"	46,0	22,0	42,0	36,0	225	10	7,95

**Leiste für Steckschlüssel-einsätze**

Zur Aufnahme von zehn 1/2" Steckschlüsseleinsätzen. Die Einsätze und die Leiste werden mit Hilfe von Magnetleisten gehalten.

Rail for sockets

A strong magnet securely holds the sockets rail to ferrous metal.

Strip voor dopsleutels

Voor 10 dopsleutels 1/2". De dopsleutels worden door magneten op hun plek gehouden.

Rail pour douilles

Rangement pour 10 douilles 1/2". Fixation du rail et maintien des douilles par le puissant aimantage.

Regla para sujeción

de llaves de vaso

Barnizado. Regla sujeta por imán.

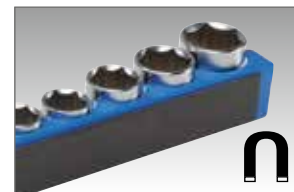
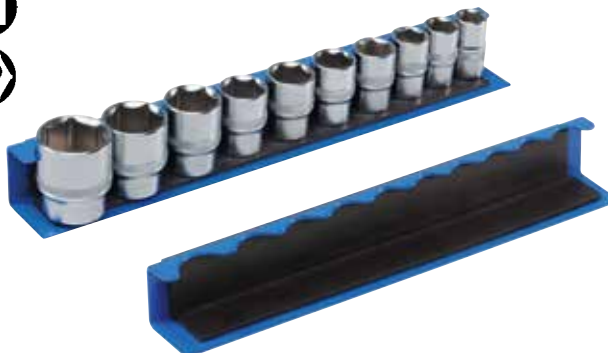

Bestell-No./Order-No.	Art. No.	ØMM	CLD mm	g	mm	€
50850790083	50850-79	10/11/12/13/15/17/19/21/22/24	320	1210	1	47,80
* 98718500000	98718-50	leer/empty	320	600	1	21,95

\* Auslauf / Discontinued

1/2"

**50850-19**  
DIN 3124 / ISO 2725

Steckschlüsseinsätze,  
extra lang

Chrom-Vanadium, verchromt

Sockets, extra deep

Chrome-Vanadium, chromium plated

Dopsleutels, verlengd

Chroom-Vanadium, verchromd

Douilles, extra longues

Chrome-Vanadium, chromées

Llaves de vaso, extra-largas

Cromo Vanadio, cromadas

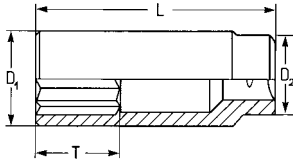

Bestell.-No./Order-No.	MM	CL mm	T mm	D1 mm	D2 mm	g		€
<b>50850191083</b>	10	77,0	35,0	14,8	22,0	86	10	<b>4,90</b>
<b>50850191383</b>	13	77,0	35,0	18,8	22,0	105	10	<b>5,45</b>
<b>50850191483</b>	14	77,0	35,0	20,5	22,0	105	10	<b>5,45</b>
<b>50850191583</b>	15	77,0	35,0	22,0	22,0	115	10	<b>5,45</b>
<b>50850191783</b>	17	77,0	35,0	24,0	22,0	130	10	<b>5,55</b>
<b>50850191983</b>	19	77,0	35,0	26,0	23,0	145	10	<b>6,15</b>
<b>50850192283</b>	22	77,0	35,0	26,0	24,0	160	10	<b>6,50</b>
<b>50850192483</b>	24	77,0	35,0	28,0	24,0	170	10	<b>7,25</b>

**50850-20**

Steckschlüsseinsätze  
für Außen-TORX®-Schrauben

Chrom-Vanadium, verchromt

Sockets for

TORX®-head screws

Chrome-Vanadium, chromium plated

Dopsleutels voor

TORX® bouten

Chroom-Vanadium, verchromd

Douilles pour vis

TORX® extérieures

Chrome-Vanadium, chromées

Llaves de vaso para tornillos

TORX® exteriores

Cromo Vanadio, cromadas

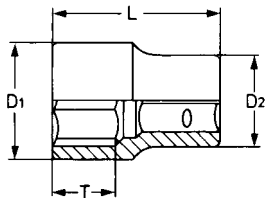

Bestell.-No./Order-No.	E	mm	CL mm	T mm	D1 mm	D2 mm	g		€
<b>50850201083</b>	E 10	9,42	38,0	14,0	15,0	22,0	53	10	<b>4,80</b>
<b>50850201183</b>	E 11	10,08	38,0	14,0	15,0	22,0	53	10	<b>4,80</b>
<b>50850201283</b>	E 12	11,17	38,0	14,0	15,0	22,0	53	10	<b>4,80</b>
<b>50850201483</b>	E 14	12,90	38,0	14,0	17,0	22,0	55	10	<b>4,80</b>
<b>50850201683</b>	E 16	14,76	38,0	14,0	19,0	22,0	55	10	<b>4,80</b>
<b>50850201883</b>	E 18	16,70	38,0	14,0	21,0	24,0	73	10	<b>5,05</b>
<b>50850202083</b>	E 20	18,49	38,0	14,0	24,0	22,0	68	10	<b>5,30</b>
<b>50850202283</b>	E 22	20,32	38,0	14,0	26,0	23,0	80	10	<b>5,30</b>
<b>50850202483</b>	E 24	22,16	38,0	14,0	28,0	24,0	96	10	<b>5,50</b>

**50850-19-1/50850-19-3**  
DIN 3124 / ISO 2725

Zündkerzeneinsätze

Chrom-Vanadium, verchromt  
mit Gummisicherung

Spark plug sockets

Chrome-Vanadium, chromium plated  
with rubber insert

Bougiedopsleutel

Chroom-Vanadium, verchromd  
met rubber inleg

Douilles pour bougies

Chrome-Vanadium, chromées  
avec bague de caoutchouc

Llaves de vaso, para bujías

Cromo Vanadio, cromadas  
con injerto de goma

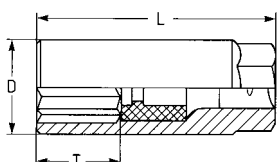

Bestell.-No./Order-No.	Art. No.	MM	AF	CL mm	T mm	D mm	MM	g		€
<b>50850190383</b>	50850-19-3	16,0	5/8"	67,0	26,0	22,0	20,0	90	10	<b>3,75</b>
<b>50850190483</b>	50850-19-4	18,0	11/16"	67,0	26,0	24,5	22,0	140	10	<b>5,55</b>
<b>50850190183</b>	50850-19-1	20,8	13/16"	67,0	26,0	27,5	24,0	130	10	<b>4,80</b>



## 50850-31 / -33

### Schraubendreher-Einsätze

Chrom-Vanadium, verchromt

Screwdriver sockets

Chrome-Vanadium, chromium plated

Schroevendraaier dopseutels

Chroom-Vanadium, verchromd

Douilles tournevis

Chrome-Vanadium, chromées

Llaves de vaso con destornillador

Cromo Vanadio, cromadas



50850-31

50850-33

XZN

NEW

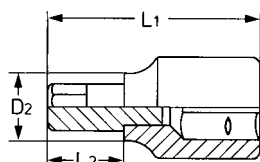

Bestell-No./Order-No.	Art. No.	MM	L1 mm	L2 mm	D2 mm	g	mm	€
<b>50850310083</b>	50850-31-0	4	62,0	24,0	18,0	85	10	<b>4,20</b>
<b>50850311383</b>	50850-31-13	4	138,0	100,0	18,0	118	5	<b>5,85</b>
<b>50850310283</b>	50850-31-2	5	62,0	24,0	18,0	87	10	<b>4,20</b>
<b>50850311483</b>	50850-31-14	5	138,0	100,0	18,0	118	5	<b>5,85</b>
<b>50850310383</b>	50850-31-3	6	62,0	24,0	18,0	88	10	<b>4,20</b>
<b>50850312283</b>	50850-31-22	6	100,0	62,0	18,0	105	5	<b>5,70</b>
<b>50850311583</b>	50850-31-15	6	138,0	100,0	18,0	118	5	<b>5,95</b>
<b>50850310183</b>	50850-31-1	7	62,0	24,0	18,0	90	10	<b>4,20</b>
<b>50850311683</b>	50850-31-16	7	138,0	100,0	18,0	120	5	<b>5,85</b>
<b>50850310483</b>	50850-31-4	8	62,0	24,0	18,0	90	10	<b>4,20</b>
<b>50850312483</b>	50850-31-24	8	100,0	62,0	18,0	107	5	<b>5,70</b>
<b>50850311283</b>	50850-31-12	8	138,0	100,0	18,0	122	5	<b>5,85</b>
<b>50850313183</b>	50850-31-31	9	62,0	24,0	18,0	90	10	<b>4,25</b>
<b>50850313283</b>	50850-31-32	9	100,0	62,0	18,0	120	5	<b>5,95</b>
<b>50850310583</b>	50850-31-5	10	62,0	24,0	18,0	93	10	<b>4,60</b>
<b>50850312583</b>	50850-31-25	10	100,0	62,0	18,0	120	5	<b>6,50</b>
<b>50850311183</b>	50850-31-11	10	138,0	100,0	18,0	144	5	<b>7,05</b>
<b>50850310683</b>	50850-31-6	12	62,0	24,0	20,0	102	10	<b>4,75</b>
<b>50850312683</b>	50850-31-26	12	100,0	62,0	20,0	142	5	<b>7,25</b>
<b>50850311883</b>	50850-31-18	12	138,0	100,0	20,0	175	5	<b>8,20</b>
<b>50850310783</b>	50850-31-7	14	62,0	24,0	22,0	120	10	<b>5,30</b>
<b>50850312783</b>	50850-31-27	14	100,0	62,0	22,0	173	5	<b>8,10</b>
<b>50850311783</b>	50850-31-17	14	138,0	100,0	22,0	217	5	<b>10,20</b>
<b>50850312883</b>	50850-31-28	16	62,0	24,0	26,0	156	10	<b>6,35</b>
<b>50850310883</b>	50850-31-8	17	62,0	24,0	26,0	158	10	<b>6,60</b>
<b>50850311083</b>	50850-31-10	17	138,0	100,0	26,0	305	5	<b>13,50</b>
<b>50850310983</b>	50850-31-9	19	62,0	24,0	26,0	168	10	<b>7,25</b>
<b>50850311983</b>	50850-31-19	19	138,0	100,0	26,0	350	5	<b>15,80</b>
<b>50850312983</b>	50850-31-29	22	62,0	24,0	26,0	188	10	<b>7,95</b>
<b>50850313083</b>	50850-31-30	24	66,0	24,0	26,0	200	10	<b>9,00</b>

Bestell-No./Order-No.	Art. No.	MM	L1 mm	L2 mm	D2 mm	g	mm	€
<b>50850330183</b>	50850-33-1	M 5	62,0	24,0	18,0	86	10	<b>5,50</b>
<b>50850332183</b>	50850-33-21	M 5	138,0	100,0	18,0	118	5	<b>7,90</b>
<b>50850330283</b>	50850-33-2	M 6	62,0	24,0	18,0	88	10	<b>5,50</b>
<b>50850331283</b>	50850-33-12	M 6	100,0	62,0	18,0	102	5	<b>5,95</b>
<b>50850332283</b>	50850-33-22	M 6	138,0	100,0	18,0	118	5	<b>7,90</b>
<b>50850330383</b>	50850-33-3	M 7	62,0	24,0	18,0	88	10	<b>5,50</b>
<b>50850332383</b>	50850-33-23	M 7	138,0	100,0	18,0	119	5	<b>7,90</b>
<b>50850330483</b>	50850-33-4	M 8	62,0	24,0	18,0	88	10	<b>5,50</b>
<b>50850331483</b>	50850-33-14	M 8	100,0	62,0	18,0	104	5	<b>5,95</b>
<b>50850332483</b>	50850-33-24	M 8	138,0	100,0	18,0	120	5	<b>7,90</b>
<b>50850330583</b>	50850-33-5	M 10	62,0	24,0	18,0	91	10	<b>5,65</b>
<b>50850331583</b>	50850-33-15	M 10	100,0	62,0	18,0	118	5	<b>6,20</b>
<b>50850332583</b>	50850-33-25	M 10	138,0	100,0	18,0	140	5	<b>9,95</b>
<b>50850330683</b>	50850-33-06	M 12	62,0	24,0	20,0	100	10	<b>6,50</b>
<b>50850331683</b>	50850-33-16	M 12	100,0	62,0	20,0	139	5	<b>8,15</b>
<b>50850332683</b>	50850-33-26	M 12	138,0	100,0	20,0	170	5	<b>11,10</b>
<b>50850330783</b>	50850-33-07	M 14	62,0	24,0	22,0	113	10	<b>7,25</b>
<b>50850332783</b>	50850-33-27	M 14	138,0	100,0	22,0	212	5	<b>13,20</b>

**50850-34/-36/-37**

**Schraubendreher-Einsätze**

Chrom-Vanadium, verchromt

Screwdriver sockets

Chrome-Vanadium, chromium plated

Schroevendraaier dopseutels

Chroom-Vanadium, verchromd

Douilles tournevis

Chrome-Vanadium, chromées

Llaves de vaso con destornillador

Cromo Vanadio, cromadas



50850-34  
RIBE

50850-36  
TORX®

50850-37  
Tamper TORX®

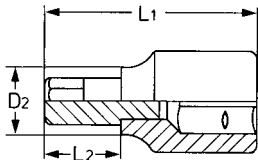

Bestell.-No./Order-No.	Art. No.		L1 mm	L2 mm	D2 mm			€
<b>50850340183</b>	50850-34-1	M 5	62,0	24,0	18,0	87	10	<b>6,10</b>
<b>50850342183</b>	50850-34-21	M 5	138,0	100,0	18,0	118	5	<b>8,70</b>
<b>50850340283</b>	50850-34-2	M 6	62,0	24,0	18,0	88	10	<b>6,20</b>
<b>50850342283</b>	50850-34-22	M 6	138,0	100,0	18,0	119	5	<b>8,70</b>
<b>50850340383</b>	50850-34-3	M 7	62,0	24,0	18,0	88	10	<b>6,10</b>
<b>50850342383</b>	50850-34-23	M 7	138,0	100,0	18,0	119	5	<b>8,70</b>
<b>50850340483</b>	50850-34-4	M 8	62,0	24,0	18,0	89	10	<b>6,10</b>
<b>50850342483</b>	50850-34-24	M 8	138,0	100,0	18,0	119	5	<b>8,70</b>
<b>50850340583</b>	50850-34-5	M 10	62,0	24,0	18,0	91	10	<b>6,10</b>
<b>50850342583</b>	50850-34-25	M 10	138,0	100,0	18,0	141	5	<b>9,15</b>
<b>50850340683</b>	50850-34-06	M 12	62,0	24,0	20,0	101	10	<b>7,90</b>
<b>50850342683</b>	50850-34-26	M 12	138,0	100,0	20,0	173	5	<b>11,95</b>
<b>50850340783</b>	50850-34-07	M 14	62,0	24,0	22,0	114	10	<b>9,80</b>
<b>50850342783</b>	50850-34-27	M 14	138,0	100,0	22,0	212	5	<b>13,70</b>

Bestell.-No./Order-No.	Art. No.			L1 mm	L2 mm	D2 mm			€
<b>50850362083</b>	50850-36-20	T 20	3,86	62,0	24,0	18,0	86	10	<b>4,80</b>
<b>50850361083</b>	50850-36-10	T 20	3,86	138,0	100,0	18,0	117	5	<b>6,60</b>
<b>50850362583</b>	50850-36-25	T 25	4,43	62,0	24,0	18,0	86	10	<b>4,80</b>
<b>50850361183</b>	50850-36-11	T 25	4,43	138,0	100,0	18,0	119	5	<b>6,60</b>
<b>50850362783</b>	50850-36-27	T 27	4,99	62,0	24,0	18,0	86	10	<b>4,80</b>
<b>50850361283</b>	50850-36-12	T 27	4,99	138,0	100,0	18,0	119	5	<b>6,60</b>
<b>50850363083</b>	50850-36-30	T 30	5,62	62,0	24,0	18,0	87	10	<b>4,80</b>
<b>50850360383</b>	50850-36-3	T 30	5,62	100,0	62,0	18,0	100	5	<b>5,75</b>
<b>50850361383</b>	50850-36-13	T 30	5,62	138,0	100,0	18,0	118	5	<b>6,60</b>
<b>50850364083</b>	50850-36-40	T 40	6,65	62,0	24,0	18,0	88	10	<b>4,80</b>
<b>50850360483</b>	50850-36-4	T 40	6,65	100,0	62,0	18,0	102	5	<b>5,75</b>
<b>50850361483</b>	50850-36-14	T 40	6,65	138,0	100,0	18,0	120	5	<b>6,60</b>
<b>50850364583</b>	50850-36-45	T 45	7,82	62,0	24,0	18,0	88	10	<b>4,80</b>
<b>50850361583</b>	50850-36-15	T 45	7,82	138,0	100,0	18,0	120	5	<b>6,60</b>
<b>50850365083</b>	50850-36-50	T 50	8,83	62,0	24,0	18,0	90	10	<b>4,80</b>
<b>50850360683</b>	50850-36-6	T 50	8,83	100,0	62,0	18,0	115	5	<b>5,75</b>
<b>50850361683</b>	50850-36-16	T 50	8,83	138,0	100,0	18,0	120	5	<b>6,60</b>
<b>50850365583</b>	50850-36-55	T 55	11,22	62,0	24,0	18,0	92	10	<b>5,15</b>
<b>50850361783</b>	50850-36-17	T 55	11,22	138,0	100,0	18,0	142	5	<b>8,50</b>
<b>50850366083</b>	50850-36-60	T 60	13,25	62,0	24,0	20,0	100	10	<b>5,85</b>
<b>50850360883</b>	50850-36-8	T 60	13,25	100,0	62,0	20,0	138	5	<b>7,90</b>
<b>50850361883</b>	50850-36-18	T 60	13,25	138,0	100,0	20,0	173	5	<b>9,80</b>
<b>50850367083</b>	50850-36-70	T 70	13,25	62,0	24,0	22,0	114	10	<b>6,50</b>
<b>50850361983</b>	50850-36-19	T 70	13,25	138,0	100,0	22,0	213	5	<b>12,45</b>

Bestell.-No./Order-No.	Art. No.			L1 mm	L2 mm	D2 mm			€
<b>50850372083</b>	50850-37-20	TT20	3,86	62,0	24,0	18,0	86	10	<b>4,80</b>
<b>50850372583</b>	50850-37-25	TT25	4,43	62,0	24,0	18,0	86	10	<b>4,80</b>
<b>50850372783</b>	50850-37-27	TT27	4,99	62,0	24,0	18,0	86	10	<b>4,80</b>
<b>50850373083</b>	50850-37-30	TT30	5,62	62,0	24,0	18,0	86	10	<b>4,80</b>
<b>50850374083</b>	50850-37-40	TT40	6,65	62,0	24,0	18,0	87	10	<b>4,80</b>
<b>50850374583</b>	50850-37-45	TT45	7,82	62,0	24,0	18,0	88	10	<b>4,80</b>
<b>50850375083</b>	50850-37-50	TT50	8,83	62,0	24,0	18,0	88	10	<b>4,80</b>
<b>50850375583</b>	50850-37-55	TT55	11,22	62,0	24,0	18,0	90	10	<b>5,35</b>
<b>50850376083</b>	50850-37-60	TT60	13,25	62,0	24,0	20,0	100	10	<b>5,95</b>

1/2"

### 50880-1

#### Einsatzspender, leer

Zur Aufbewahrung und Präsentation von Steckschlüsseinsätzen und Schraubendrehereinsätzen aller Art. Variable Einteilung durch Trennsystem. Zusammenstellung von Sortimenten nach eigenem Belieben möglich.

#### Socket dispenser, empty

For storage and presentation of sockets. Variable system of partitions permits composition of different assortments to choice.

#### Dopsleuteldisplay, leeg

Voor het opbergen en presenteren van dopsleutels en schroevendraaierdopsleutels. Variabele indeling door verdeelschotten. Assortiment naar eigen wens samen te stellen.

#### Présentoir métallique, vide

Pour la présentation de douilles et douilles tournevis. Un système variable de cloisonnement permet des compositions différentes au choix.

#### Expositor combinado, vacío

Para el almacenamiento y presentación de llaves de vaso y vasos con destornillador. Separaciones ajustables por sistema de listones que permiten componer los surtidos a elección del usuario.



Bestell-No./Order-No.	Art. No.	Maße · Dimensions			€
<b>5088000020</b>	50880-1	350 x 420 x 350 mm	9700	1	<b>290,80</b>

### 50825-65

1/4"

#### Einsatzspender

mit 1/4" Sortiment, 491-tlg.

#### Socket dispenser

with 1/4" assortment, 491 pcs.

#### Dopsleuteldisplay

met 1/4" assortiment, 491-dlg.

#### Présentoir équipé

avec assortiment 1/4", 491 pcs.

#### Expositor combinado

con 1/4" surtido, 491 pzs.

1/4"

SP



enthaltend/containing

je 10 Stk./pcs. MM 4/4,5/5/5,5/6/7/8/9/10/11/12/13	37 mm / je 10 Stk./pcs.
je 10 Stk./pcs. MM 6/7/8/9/10/11/12/13	50 mm / je 10 Stk./pcs.
je 10 Stk./pcs. E 4/5/6/7/8/10	100 mm / je 10 Stk./pcs.
je 10 Stk./pcs. 4/5,5	115 mm / je 10 Stk./pcs.
je 10 Stk./pcs. PH 1/2	150 mm / je 10 Stk./pcs.
je 10 Stk./pcs. PZ 1/2	150 mm / je 10 Stk./pcs.
je 10 Stk./pcs. MM 3/4/5/6	
je 10 Stk./pcs. TT 10/15/20/25/27/30/40	

Abbildung enthält Sonderausstattung · Picture shows extras

Bestell-No./Order-No.	Art. No.	Maße · Dimensions			€
<b>50825006583</b>	50825-65	350 x 420 x 350 mm	21300	1	<b>1.098,60</b>

1/2"

**50850-65**

1/2"

**Einsatzspender**

mit 1/2" Sortiment, 332-tlg.

**Socket dispenser**

with 1/2" assortment, 332 pcs.

**Dopsleuteldisplay**

met 1/2" assortiment, 332-dlg.

**Présentoir équipé**

avec assortiment 1/2", 332 pces.

**Expositor combinado**

con 1/2" surtido, 332 pzs.

1/2"

SP



enthaltend/containing









 je 10 Stk./pcs.	MM 8/9/10/11/12/13/14/15/16	 je 7 Stk./pcs.	MM 6/8/10/12/14
 je 10 Stk./pcs.	MM 17/18/19/20/21/22/23/24/	 je 7 Stk./pcs.	T 25/27/30/40/45
 je 7 Stk./pcs.	27/30/32	 je 7 Stk./pcs.	M 6/8/10/12
 je 7 Stk./pcs.	E 10/11/12/14/16/18		

Abbildung enthält Sonderausstattung · Picture shows extras

Bestell-No./Order-No.	Art. No.	Maße · Dimensions			€
<b>50850006583</b>	50850-65	350 x 420 x 350 mm	36600	1	<b>1.098,60</b>

**50825-5065**

1/4" + 1/2"

**Einsatzspender**

mit 1/4" + 1/2" Sortiment, 442-tlg.

**Socket dispenser**

with 1/4" + 1/2" assortment, 442 pcs.

**Dopsleuteldisplay**

met 1/4" + 1/2" assortiment, 442-dlg.

**Présentoir équipé**

avec assortiment 1/4" + 1/2", 442 pces.

**Expositor combinado**

con 1/4" + 1/2" surtido, 442 pzs.

1/4"

1/2"

SP



enthaltend/containing









 je 10 Stk./pcs.	MM 4/4,5/5/5,5/6/7/8/9/10/11/12/13/14/15	 je 10 Stk./pcs.	MM 8/9/10/11/12/13/14/15/16/17/18/19/20/21/22/23/24
 je 10 Stk./pcs.	7	 je 7 Stk./pcs.	27/30/32
 je 10 Stk./pcs.	PH 2	 je 10 Stk./pcs.	MM 6/8/10/12/14
 je 10 Stk./pcs.	MM 3/4/5/6		

Abbildung enthält Sonderausstattung · Picture shows extras

Bestell-No./Order-No.	Art. No.	Maße · Dimensions			€
<b>50825506583</b>	50825-5065	350 x 420 x 350 mm	33300	1	<b>1.098,60</b>



### 50872-3015

19-tlg./pcs./-dlg./pces./pzs.

### 50873-3015

21-tlg./pcs./-dlg./pces./pzs.

#### Steckschlüsselgarnitur

Chrom-Vanadium, verchromt, in Metallkasten.

#### Socket set

Chrome-Vanadium, chromium plated, in metal case.

#### Dopsleutelset

Chrom-Vanadium, verchromd, in metalen koffer.

#### Composition de douilles

Chrom-Vanadium, chromées, en coffret métallique.

#### Conjunto de llaves de vaso

Cromo Vanadio, cromadas, en caja metálica.



enthaltend/containing	
	250 mm
	250 mm 125 mm
	75 mm
	3/8"  1/2"
	MM 10/11/12/13/ 14/15/16/17/19/ 22/24/ 27/30/32

Bestell-No./Order-No.	Art. No.	Maße · Dimensions			€
<b>50872301583</b>	50872-3015	407 x 162 x 52 mm	3910	1	<b>184,80</b>



enthaltend/containing	
wie - as 50872-3015 +	
	MM 16/20,8

Bestell-No./Order-No.	Art. No.	Maße · Dimensions			€
<b>50873301583</b>	50873-3015	407 x 162 x 52 mm	4130	1	<b>197,75</b>

### 50870-3015

13-tlg./pcs./-dlg./pces./pzs.

#### Steckschlüsselgarnitur

Chrom-Vanadium, verchromt, in Metallkasten.

#### Socket set

Chrome-Vanadium, chromium plated, in metal case.

#### Dopsleutelset

Chrom-Vanadium, verchromd, in metalen koffer.

#### Composition de douilles

Chrom-Vanadium, chromées, en coffret métallique.

#### Conjunto de llaves de vaso

Cromo Vanadio, cromadas, en caja metálica.



enthaltend/containing	
	250 mm
	125 mm
	MM 8/10/11/13/15/ 17/18/19/22/24
	MM 20,8

Bestell-No./Order-No.	Art. No.	Maße · Dimensions			€
<b>50870301583</b>	50870-3015	318 x 119 x 49 mm	2300	1	<b>118,90</b>



1/2"

**50870-3115**

13-tlg./pcs./dlg./pces./pzs.

**Steckschlüsselgarnitur**

Chrom-Vanadium, verchromt, in Metallkasten.

Socket set

Chrome-Vanadium, chromium plated, in metal case.

Dopsleutelset

Chroom-Vanadium, verchromd, in metalen koffer.

Composition de douilles

Chrome-Vanadium, chromées, en coffret métallique.

Conjunto de llaves de vaso

Cromo Vanadio, cromadas, en caja metálica.



enthaltend/containing	
	250 mm
	125 mm
	MM 8/10/11/13/15/17/18/19/22/24
	75 mm

Bestell-No./Order-No.	Art. No.	Maße · Dimensions			€
<b>50870311583</b>	50870-3115	318 x 119 x 49 mm	2310	1	<b>125,35</b>

**50852-2016**

21-tlg./pcs./dlg./pces./pzs.

**Steckschlüsselgarnitur, AF**

Chrom-Vanadium, verchromt, mit 2-K Schaumstoffeinlage in Metallkasten.

Socket set, AF

Chrome-Vanadium, chromium plated, with 2 components foam insert in metal case.

Dopsleutelset, AF

Chroom-Vanadium, verchromd, met 2 componenten schuimleg in metalen koffer.

Composition de douilles, AF

Chrome-Vanadium, chromées, avec plateau mousse bicolore, en coffret métallique.

Conjunto de llaves de vaso, AF

Cromo Vanadio, cromadas, con material de espuma 2 compo-santes alta gama en caja metálica.



enthaltend/containing	
	255 mm
	250 mm
	125 mm
	75 mm
	AF 3/8" / 7/16" / 1/2" / 9/16" / 5/8" / 11/16" / 3/4" / 13/16" / 7/8" / 15/16" / 1" / 1.1/16" / 1.1/8" / 1.3/16" / 1.1/4"
	AF 5/8" / 13/16"

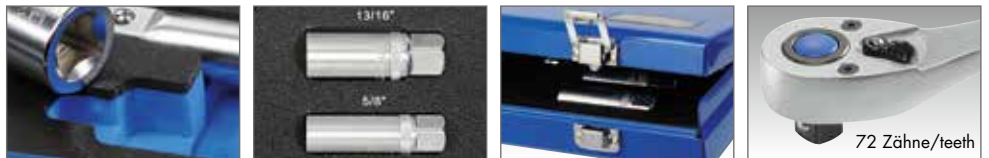

Bestell-No./Order-No.	Art. No.	Maße · Dimensions			€
* <b>50852201683</b>	50852-2016	440 x 180 x 55 mm	5180	1	<b>187,45</b>

\* Auslauf / Discontinued

**50853-3015**

39-tlg./pcs./dlg./pces./pzs.

**Steckschlüsselgarnitur**

Chrom-Vanadium, verchromt, in Kunststoffkoffer.

Socket set

Chrome-Vanadium, chromium plated, in plastic box.

Dopsleutelset

Chroom-Vanadium, verchromd, in kunststof koffer.

Composition de douilles

Chrome-Vanadium, chromées, en coffret plastique.

Conjunto de llaves de vaso

Cromo Vanadio, cromadas, en caja de plástico.



enthaltend/containing	
	250 mm
	250 mm
	125 mm
	75 mm
	MM 10/11/12/13/14/15/16/17/18/19/20/21/22/23/24/27/30/32
	MM 16/20,8
	MM 10/13/17/19
	CLD 62 mm 5/6/8/10/12/14
	CLD 62 mm TT 30/40/45/50

Bestell-No./Order-No.	Art. No.	Maße · Dimensions			€
<b>50853301583</b>	50853-3015	350 x 280 x 80 mm	5500	1	<b>205,50</b>

**1/2"****50854-3016**

28-tlg./pcs./dlg./pces./pzs.

**Steckschlüsselgarnitur**

Chrom-Vanadium, verchromt, mit 2-K Schaumstoffeinlage in Metallkasten.

## Socket set

Chrome-Vanadium, chromium plated, with 2 components foam insert in metal case.

## Dopsleutelset

Chroom-Vanadium, verchromd, met 2 componenten schuimleg in metalen koffer.

## Composition de douilles

Chrome-Vanadium, chromées, avec plateau mousse bicolore, en coffret métallique.

## Conjunto de llaves de vaso

Cromo Vanadio, cromadas, con material de espuma 2 compo-santes alta gama en caja metálica.

**1/2"**

SP



enthaltend/containing



255 mm



250 mm



125 mm



75 mm

MM 10/11/12/13/14/15/16/17/18/19/  
20/21/22/23/24/27/30/32

MM 16/20,8



MM 10/13/17/19

Bestell-No./Order-No.	Art. No.	Maße · Dimensions			€
<b>50854301683</b>	50854-3016	440 x 180 x 55 mm	5670	1	<b>205,50</b>

**50883-3016**

61-tlg./pcs./dlg./pces./pzs.

**Steckschlüsselgarnitur**

Chrom-Vanadium, verchromt, mit 2-K Schaumstoffeinlage in Metallkasten.

## Socket set

Chrome-Vanadium, chromium plated, with 2 components foam insert in metal case.

## Dopsleutelset

Chroom-Vanadium, verchromd, met 2 componenten schuimleg in metalen koffer.

## Composition de douilles

Chrome-Vanadium, chromées, avec plateau mousse bicolore, en coffret métallique.

## Conjunto de llaves de vaso

Cromo Vanadio, cromadas, con material de espuma 2 compo-santes alta gama en caja metálica.

**1/2"****1/4"**

SP



enthaltend/containing



150 + 255 mm



250 mm



115 + 250 mm



150 mm



50 + 125 mm



37 + 75 mm

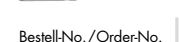

MM 16/20,8

**1/4"**

MM 4/4,5/5/5,5/6/7/8/9/10/11/12/13

**1/2"**MM 14/15/16/17/18/19/20/21/22/23/  
24/27/30/32

PH 1/2/3



3/4/5/6



4/5,5/7



TT 8/10/15/20/25/27/30/40



E 4/5/6/7/8/10

Bestell-No./Order-No.	Art. No.	Maße · Dimensions			€
<b>50883301683</b>	50883-3016	430 x 250 x 65 mm	6000	1	<b>252,05</b>



Manchmal sind es die Kleinigkeiten, die unsere Werkzeuge so einzigartig machen. Doch gerade diese Details sorgen für den Unterschied, wenn es um Arbeitserleichterung, längere Lebensdauer und Zuverlässigkeit geht. Hier zeigt sich einmal mehr, dass wir an alles denken, damit Sie von unseren Werkzeugen begeistert sind.

Sometimes, it is the smallest things that make our tools so unique. But, when it comes to reducing the workload, extending service life and ensuring reliability, these are the details that make the difference. This is one more example that shows that we think of everything to make sure you are delighted by our tools.

1/2"

### 50825-5015

105-tlg./pcs./-dlg./pces./pzs.

#### Steckschlüsselgarnitur

Chrom-Vanadium, verchromt, in Kunststoffkoffer.

#### Socket set

Chrome-Vanadium, chromium plated, in plastic box.

#### Dopsleutelset

Chroom-Vanadium, verchromd, in kunststof koffer.

#### Composition de douilles

Chrome-Vanadium, chromées, en coffret plastique.

#### Conjunto de llaves de vaso

Cromo Vanadio, cromadas, en caja de plástico.

1/2"

1/4"

SP



enthaltend/containing	
	150 mm
	50 / 100 mm
	115 mm
	37 mm
	150 mm
	MM 4/4,5/5/5,5/6/7/8/9/10/11/12/13/14
	MM 6/7/8/9/10/11/12/13
	250 mm
	125 / 250 mm
	3/8" 1/2"
	75 mm
	MM 10/11/12/13/14/15/16/17/18/19/20/21/22/23/24/27/30/32
	MM 14/15/17/19
	MM 16/20,8
	PZ 1 / PZ 2
	3/4/5/6
	4/5,5/7
	PH 1 / PH 2
	TT 8/10/15/20/25/27/30
	R1 - R2
	PH1 - 3
	3,5 - 8
	PZ 1 - 3
	2 - 8
	TT 9 - 40

**HEYTEC**  
BESTSELLER



Bestell-No./Order-No.	Art. No.	Maße · Dimensions			€
<b>50825501583</b>	50825-5015	420 x 320 x 75 mm	6500	1	<b>295,30</b>



1/2"

### Schraubendreher-einsatz-Sortiment

Screwdriver socket set

Schroevendraaier  
dopsleutelset

Composition de douilles-  
tournevis

Surtido de llaves de vaso  
con destornillador

#### 50850-53

33-tlg./pcs./dlg./pces./pzs.

Chrom-Vanadium, verchromt,  
in Kunststoffkoffer.

Chrome-Vanadium, chromium plated,  
in plastic box.

Chroom-Vanadium, verchroomd,  
in kunststof koffer.

Chrome-Vanadium, chromées,  
en coffret plastique.

Cromo Vanadio, cromadas,  
en caja de plástico.

1/2"



enthaltend/containing			
	CLD 62 mm	MM 5/6/7/8/10/12/14/17	
	CLD 62 mm	TT 25/27/30/40/45/50/55/60	
	CLD 62 mm	M 5/6/8/10	
	CLD 100 mm	MM 6/8/10/12/14	
	CLD 100 mm	T 30/40/50/60	
	CLD 100 mm	M 6/8/10/12	

← 62 mm →



← 100 mm →



Bestell-No./Order-No.	Art. No.	Maße · Dimensions			€
* 50850530083	50850-53	350 x 280 x 80 mm	4400	1	175,30

\* Auslauf / Discontinued

#### 50850-54

28-tlg./pcs./dlg./pces./pzs.

Chrom-Vanadium, verchromt, für  
Schrauben mit Innen-RIBE und Vielzahn  
XZN-Köpfen, in Kunststoffkoffer.

Chrome-Vanadium, chromium plated, in  
plastic box, for fluted socket screws RIBE  
for multi-spline socket screws XZN.

Chroom-Vanadium, verchroomd, voor  
schroeven met interne-RIBE en meertands  
XZN-koppen, in kunststof koffer.

Chrome-Vanadium, chromées, en coffret  
plastique, pour vis RIBE int. pour vis XZN  
int. multi-dents.

Cromo Vanadio, cromadas, en caja de  
plástico, para tornillos RIBE y XZN.

1/2"



enthaltend/containing			
	CLD 62 mm	M 5/6/7/8/10/12/14	
	CLD 62 mm	M 5/6/7/8/10/12/14	
	CLD 138 mm	M 5/6/7/8/10/12/14	
	CLD 138 mm	M 5/6/7/8/10/12/14	

← 138 mm →

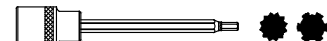

← 62 mm →



Bestell-No./Order-No.	Art. No.	Maße · Dimensions			€
* 50850540083	50850-54	350 x 280 x 80 mm	4230	1	175,30

\* Auslauf / Discontinued

#### 50850-55

18-tlg./pcs./dlg./pces./pzs.

Chrom-Vanadium, verchromt,  
in Metallkasten.

Chrome-Vanadium, chromium plated,  
in metal case.

Chroom-Vanadium, verchroomd,  
in metalen koffer.

Chrome-Vanadium, chromées,  
en coffret métallique.

Cromo Vanadio, cromadas,  
en caja metálica.

1/4"

1/2"



enthaltend/containing			
	CLD 62 mm	T 20/25/27/30/40/45/50/55/60/70	
	CLD 37 mm	TT 8/10/15/20/25/27/30/40	

Bestell-No./Order-No.	Art. No.	Maße · Dimensions			€
50850550083	50850-55	220 x 120 x 40 mm	1500	1	98,35

1/2"

## Schraubendreher-einsatz-Sortiment

Screwdriver socket set

Schroevendraaier dopsleutelset

Composition de douilles-tournevis

Surtido de llaves de vaso con destornillador

### 50850-56

7-tlg./pcs./dlg./pces./pzs.

Chrom-Vanadium, verchromt, in Metallkasten.

Chrome-Vanadium, chromium plated, in metal case.

Chroom-Vanadium, verchromd, in metalen koffer.

Chrome-Vanadium, chromées, en coffret métallique.

Cromo Vanadio, cromadas, en caja metálica.

1/2"



enthaltend/containing

CL 62 mm 6/7/8/10/12/14/17



Bestell-No./Order-No.	Art. No.	Maße · Dimensions			€
<b>50850560283</b>	50850-56	250 x 150 x 40 mm	1570	1	<b>62,45</b>

### 50850-58

14-tlg./pcs./dlg./pces./pzs.

Chrom-Vanadium, verchromt, in Metallkasten.

Chrome-Vanadium, chromium plated, in metal case.

Chroom-Vanadium, verchromd, in metalen koffer.

Chrome-Vanadium, chromées, en coffret métallique.

Cromo Vanadio, cromadas, en caja metálica.

1/4"

1/2"



enthaltend/containing

1/2" CL 62 mm 4/5/6/7/8/10/12/14/17/19

1/4" CL 36 mm 3/4/5/6

Bestell-No./Order-No.	Art. No.	Maße · Dimensions			€
<b>50850580083</b>	50850-58	220 x 120 x 40 mm	1590	1	<b>87,00</b>

### 50850-59

9-tlg./pcs./dlg./pces./pzs.

Chrom-Vanadium, verchromt, in Metallkasten, für Tamper-TORX®-Schrauben.

Chrome-Vanadium, chromium plated, in metal case, for Tamper-TORX®-screws.

Chroom-Vanadium, verchromd, in metalen koffer, voor inwendige TORX® schroeven met stift.

Chrome-Vanadium, chromées, en coffret métallique, pour vis RESISTORX®.

Cromo Vanadio, cromadas, en caja metálica, para tornillos Tamper TORX®.

1/2"



enthaltend/containing

CL 62 mm TT 20/25/27/30/40/45/50/55/60



Bestell-No./Order-No.	Art. No.	Maße · Dimensions			€
* <b>50850590083</b>	50850-59	250 x 150 x 40 mm	1650	1	<b>85,75</b>

\* Auslauf / Discontinued



### 50850-55-12

20-tlg./pcs./-dlg./pces./pzs.

#### Schraubendreher-einsatz-Sortiment

Chrom-Vanadium, verchromt, für Innensechskantschrauben, in Kunststoffkoffer.

#### Screwdriver socket set

Chrome-Vanadium, chromium plated, in plastic box, for hexagon socket screws.

#### Schroevendraaier dopsleutelset

Chroom-Vanadium, verchromd, voor binnezesantbouten, in kunststof koffer.

#### Composition de douilles-tournevis

Chrome-Vanadium, chromées, en coffret plastique pour vis hexagonales int.

#### Surtido de llaves de vaso con destornillador

Cromo Vanadio, cromado, en caja de plástico para tornillos Allen.



#### enthaltend/containing

	CLD 62 mm	4/5/6/7/8/10/ 12/14/17/19
	CLD 138 mm	4/5/6/7/8/10/ 12/14/17/19

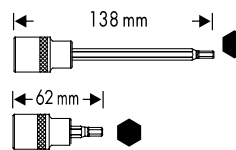

Bestell-No./Order-No.	Art. No.	Maße · Dimensions			€
<b>50850551283</b>	50850-55-12	350 x 280 x 80 mm	3765	1	<b>168,05</b>

### 50851-3015

18-tlg./pcs./-dlg./pces./pzs.

#### Steckschlüsselgarnitur

Chrom-Vanadium, verchromt, in Kunststoffkoffer.

#### Socket set

Chrome-Vanadium, chromium plated, in plastic box.

#### Dopsleutelset

Chroom-Vanadium, verchromd, in kunststof koffer.

#### Composition de douilles

Chrome-Vanadium, chromées, en coffret plastique.

#### Conjunto de llaves de vaso

Cromo Vanadio, cromadas, en caja de plástico.



#### enthaltend/containing

	250 mm
	250 mm
	125 mm
	75 mm
	MM 10/11/12/13/14/ 15/17/19/21/24/27/30/32

Bestell-No./Order-No.	Art. No.	Maße · Dimensions			€
<b>50851301583</b>	50851-3015	350 x 280 x 80 mm	3500	1	<b>134,10</b>

### 50860-3015

33-tlg./pcs./-dlg./pces./pzs.

#### Kombinierte Steckschlüssel- und Ringmaulschlüsselgarnitur

Chrom-Vanadium, verchromt, in Metallkasten.

#### Combined set of sockets and combination wrenches

Chrome-Vanadium, chromium plated, in metal case.

#### Gecombineerde dopsleutel- en ringsteeksleutelset

Chroom-Vanadium, verchromd, in metalen koffer.

#### Composition de douilles et clés mixtes

Chrome-Vanadium, chromées, en coffret métallique.

#### Juego combinados de llaves de vaso y llaves combinados

Cromo Vanadio, cromadas, en caja metálica.



#### enthaltend/containing

	250 mm
	250 mm
	125 mm
	70 mm
	MM 10/11/12/13/14/ 15/17/18/19/22/24/ 27/30/32
	MM 16/20,8
	MM 6/7/8/10/11/12/ 13/14/15/17/19/21/22

Bestell-No./Order-No.	Art. No.	Maße · Dimensions			€
<b>50860301580</b>	50860-3015	450 x 187 x 52 mm	5600	1	<b>200,35</b>



Chrom-Vanadium, verchromt  
 Chrome-Vanadium, chromium plated

### 508100-00-6

DIN 3122 D · ISO 3315

#### Umschaltknarre

Mit Druckbetätigung zum Schnellösen und zur Arretierung der Steckverbindung, 72 Zähne.

Lever type reversible ratchet  
 With quick release ejector button, 72 teeth.

Omschakelbare ratel  
 Met ontgrendelstift, 72 tanden.

Cliquet réversible  
 Tige d'éjection pour libérer rapidement l'outil du cliquet, 72 dents.

Carraca reversible  
 Con expulsor para separación instantánea de vasos y accesorios, 72 dientes.



Bestell-No./Order-No.	Art. No.		 mm			€
<b>50810000680</b>	508100-00-6	3/4"	510	1700	2	<b>157,70</b>

### 508100-13

DIN 3122 C

#### Durchsteckknarre

Mit Verbindungsvierkant, 2-tlg.

Ratchet  
 With square coupler, 2 pcs.

Doorsteekratel  
 Met verbindingsvierkant, 2 dlg.

Cliquet  
 Avec carré conducteur, 2 pcs.

Carraca  
 Pasante de acoplamiento cuadrado 2 pzs.



Bestell-No./Order-No.	Art. No.		 mm			€
<b>50810011380</b>	508100-13	3/4"	472	1485	1	<b>122,80</b>

### 508100-03

DIN 3122 A · ISO 3315

#### Griff mit Gleitstück

Sliding Thandle

Greep met schuifstuk

Poignée coulissante

Mango corredizo



Bestell-No./Order-No.	Art. No.		 mm			€
<b>50810003080</b>	508100-03	3/4"	455	1360	2	<b>43,95</b>



**3/4"****508100-04/04-1/05**  
DIN 3123 B · ISO 3316Verlängerungen  
Extension bars  
Verlengstukken  
Rallonges  
Alargaderas**HEYTEL**  
TOOLS

508100-04-1



508100-04



508100-05

Bestell-No./Order-No.	Art. No.		CLD mm			€
<b>50810004180</b>	508100-04-1	3/4"	100	440	2	<b>27,10</b>
<b>50810004080</b>	508100-04	3/4"	200	840	2	<b>34,90</b>
<b>50810005080</b>	508100-05	3/4"	400	1560	2	<b>45,25</b>

**508100-6**  
DIN 3124 / ISO 2725Steckschlüsseleinsätze,  
sechskant

Chrom-Vanadium, verchromt

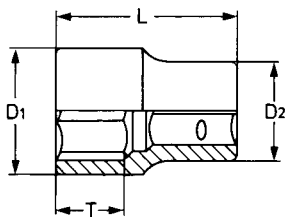
Sockets, hexagon  
Chrome-Vanadium, chromium platedDopsleutels, zeskant  
Chroom-Vanadium, verchromdDouilles, 6 pans  
Chrome-Vanadium, chroméesLlaves de vaso, boca hexagonal  
Cromo Vanadio, cromadas**SP**

Bestell-No./Order-No.		CLD mm	T mm	D1 mm	D2 mm			€
<b>50810061980</b>	19	50	15	29	33	168	5	<b>11,15</b>
<b>50810062180</b>	21	50	15	31	33	172	5	<b>11,15</b>
<b>50810062280</b>	22	50	15	33	36	211	5	<b>11,15</b>
<b>50810062380</b>	23	50	15	33	36	211	5	<b>11,15</b>
<b>50810062480</b>	24	50	15	34	36	225	5	<b>11,15</b>
<b>50810062680</b>	26	52	26	37	36	223	5	<b>12,00</b>
<b>50810062780</b>	27	52	26	38	36	224	5	<b>12,15</b>
<b>50810062980</b>	29	52	26	40	38	262	5	<b>12,80</b>
<b>50810063080</b>	30	54	26	42	38	285	5	<b>12,80</b>
<b>50810063280</b>	32	56	28	44	38	305	5	<b>15,10</b>
<b>50810063480</b>	34	56	26	47	36	390	5	<b>15,10</b>
<b>50810063580</b>	35	58	30	48	42	395	5	<b>15,10</b>
<b>50810063680</b>	36	58	30	50	42	434	5	<b>18,70</b>
<b>50810063880</b>	38	60	30	52	45	472	5	<b>18,70</b>
<b>50810064180</b>	41	64	36	56	45	550	5	<b>20,15</b>
<b>50810064680</b>	46	68	36	62	48	685	5	<b>23,55</b>
<b>50810065080</b>	50	72	40	68	48	800	5	<b>26,55</b>
<b>50810065580</b>	55	76	38	74	45	860	5	<b>29,55</b>
<b>50810066080</b>	60	78	42	80	45	1020	5	<b>33,85</b>

**50810-1401**  
DIN 3123 A · ISO 3316Adapter  
Converter  
Adapter  
Réducteur  
Reductor**3/4"****1/2"**

Bestell-No./Order-No.	Art. No.			CLD mm			€
<b>50810140180</b>	50810-1401	1/2"	3/4"	50	206	10	<b>10,30</b>



**508101-310**

Im robusten Kasten, im stabilen Koffer oder in der pflegeleichten Transporttasche. Mit unseren Sortimenten sind Sie immer optimal ausgestattet.

In robust boxes, resilient cases or easily cleanable carrying bags. Our tool ranges ensure that you always have exactly the tools you need.



**508101-310**

21-tlg./pcs./dlg./pcs./pzs.



**Steckschlüsselgarnitur**

Chrom-Vanadium, verchromt,  
in Kunststoffkoffer.

**Socket set**

Chrome-Vanadium, chromium plated,  
in plastic box.

**Dopsleutelset**

Chroom-Vanadium, verchromd,  
in kunststof koffer.

**Composition de douilles**

Chrome-Vanadium, chromées,  
en coffret plastique.

**Conjunto de llaves de vaso**

Cromo Vanadio, cromadas,  
en caja de plástico.



enthaltend/containing

	510 mm
	MM 19/21/22/23/24/26/27/29/30/32/35/36/38/41/46/50
	100 / 200 / 400 mm
	455 mm



Bestell-No./Order-No.	Art. No.	Maße · Dimensions			€
<b>50810131080</b>	508101-310	580 x 400 x 90 mm	14000	1	<b>523,95</b>





**5081129**

**Werkstattwagen, leer**

- in stabiler Metallkonstruktion verwindungssteif und hochbelastbar
- 5 Schubfächer mit Kugelführungen
- inkl. großem Staufach für Geräte, Maschinen u.ä.
- Zentralverriegelung mit Zylinderschloss

**Workshop trolley, empty open jaw wrenches**

- rigid metal construction, resisting torsional forces, for high loads
- 5 drawers with ball bearings
- large stowage room for machines and equipment
- central locking with cylinder lock

**Gereedschapswagen, leeg**

- Stabiele metalen constructie, torsiebestendig en geschikt voor zware belasting
- 5 kogelgelagerde schuifladen
- groot opbergvak voor apparaten, machines etc.
- centrale vergrendeling met cilinderslot

**Servante d'atelier, vide**

- de construction métallique robuste, haute résistance et grande capacité de charge
- 5 tiroirs avec roulements à bille
- grand casier pour outils, machines etc.
- verrouillage central avec serrure à cylindre

**Carro de herramientas, vacío**

- sólida construcción en chapa metálica, rígida y resistente
- 5 cajones con guías sobre rodamientos
- con amplio espacio para aparatos voluminosos, máquinas etc.
- cierre central con cerradura



Abmessungen inkl. Räder und Griff  
Dimensions incl. wheels and handle

Breite / width  
550 mm

Länge / length  
700 mm

Höhe / height  
980 mm



Zubehör/Accessories/Toebehoren/Accessoires/Accessorios:  
www.heyco-qualitaetswerkzeuge.de  
HEYCO Art.-No. 1129-8-1 bis 12

- 5 Schubladen/Drawers
- ① 3 Schubladen 440 x 350 x 60 mm
  - ② 1 Schublade 440 x 350 x 140 mm
  - ③ 1 Schublade 440 x 350 x 300 mm

- ca. 30 kg Belastbarkeit pro Schublade
- Leergewicht ca. 54 kg
- Tragfähigkeit bis 400 kg
- Ablagefläche 600 x 430 mm

- approx. 30 kg loading capacity for each drawer
- weight empty approx. 54 kg
- load capacity up to 400 kg
- work surface 600 x 430 mm

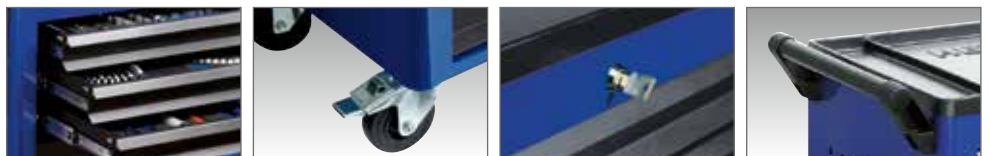

Bestell-No./Order-No.	Art. No.	Maße · Dimensions			€
<b>50811290120</b>	5081129	(L) 700 x (B) 550 x (H) 980 mm	54000	1	<b>730,35</b>

## 5081130

### Werkstattwagen, leer

- in stabiler Metallkonstruktion verwindungssteif und hochbelastbar
- 8 Schubfächer mit Kugelführungen
- inkl. großem Staufach für Geräte, Maschinen u.ä.
- Zentralverriegelung mit Zylinderschloss

### Workshop trolley, empty open jaw wrenches

- rigid metal construction, resisting torsional forces, for high loads
- 8 drawers with ball bearings
- large stowage room for machines and equipment
- central locking with cylinder lock

### Gereedschapswagen, leeg

- Stabiele metalen constructie, torsiebestendig en geschikt voor zware belasting
- 8 kogelgelagerde schuifladen
- groot opbergvak voor apparaten, machines etc.
- centrale vergrendeling met cilinderslot

### Servante d'atelier, vide

- de construction métallique robuste, haute résistance et grande capacité de charge
- 8 tiroirs avec roulements à bille
- grand casier pour outils, machines etc.
- verrouillage central avec serrure à cylindre

### Carro de herramientas, vacío

- sólida construcción en chapa metálica, rígida y resistente
- 8 cajones con guías sobre rodamientos
- con amplio espacio para aparatos voluminosos, máquinas etc.
- cierre central con cerradura



Abmessungen inkl. Räder und Griff  
Dimensions incl. wheels and handle

Breite / width  
550 mm

Länge / length  
700 mm

Höhe / height  
980 mm



Zubehör/Accessories/Toebehoren/Accessoires/Accessorios:  
www.heyco-qualitaetswerkzeuge.de  
HEYCO Art.-No. 1129-8-1 bis 12

#### 8 Schubladen/Drawers

- ① 7 Schubladen 440 x 350 x 60 mm
- ② 1 Schublade 440 x 350 x 140 mm

- ca. 30 kg Belastbarkeit pro Schublade
- Leergewicht ca. 60 kg
- Tragfähigkeit bis 400 kg
- Ablagefläche 600 x 430 mm

- approx. 30 kg loading capacity for each drawer
- weight empty approx. 60 kg
- load capacity up to 400 kg
- work surface 600 x 430 mm



Bestell-No./Order-No.	Art. No.	Maße · Dimensions			€
<b>50811300120</b>	5081130	(L) 700 x (B) 550 x (H) 980 mm	60000	1	<b>836,20</b>

## 5081129-...

Werkstattwagen  
mit Modulen

Workshop trolley  
with modules

Gereedschapswagen  
met modules

Servante d'atelier  
avec modules

Carro de herramientas  
con módulos



## 5081129-25

90-tlg./pcs./-dlg./pces./pzs.

90-tlg. in 5 Modulen

90 pcs. in 5 modules

90 delig in 5 modules

90 pces. en 5 modules

90 pzs. en 5 módulos

Details siehe Seite  
Details see page  
Details zie pagina  
Presentoirs voir page  
Expositores,  
véase página

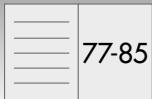

M 50829-4



M 50829-3



M 50829-12



M 50829-13



M 50829-14

Bestell-No./Order-No.	Art. No.	Maße · Dimensions					€
<b>50811292500</b>	5081129-25	M 50829-3	M 50829-4	M 50829-12	64900	1	<b>1.153,75</b>
		M 50829-13	M 50829-14				

## 5081129-26

106-tlg./pcs./-dlg./pces./pzs.

106-tlg. in 2 Modulen

106 pcs. in 2 modules

106 delig in 2 modules

106 pces. en 2 modules

106 pzs. en 2 módulos

Details siehe Seite  
Details see page  
Details zie pagina  
Presentoirs voir page  
Expositores,  
véase página

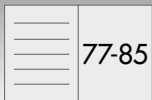

M 50829-50



M 50829-51

Bestell-No./Order-No.	Art. No.	Maße · Dimensions				€
<b>50811292600</b>	5081129-26	M 50829-50	M 50829-51	63210	1	<b>1.216,20</b>



**5081129-27**

132-tlg./pcs./-dlg./pces./pzs.

132-tlg. in 4 Modulen  
132 pcs. in 4 modules  
132 delig in 4 modules  
132 pces. en 4 modules  
132 pzs. en 4 módulos

Details siehe Seite  
Details see page  
Details zie pagina  
Presentoirs voir page  
Expositores,  
véase página

77-85



M 50829-50



M 50829-54



M 50829-51



M 50829-56

Bestell-No./Order-No.	Art. No.	Maße · Dimensions				€
<b>50811292700</b>	5081129-27	M 50829-50	M 50829-51	69580	1	<b>1.534,85</b>
		M 50829-54	M 50829-56			

**5081129-28**

100-tlg./pcs./-dlg./pces./pzs.

100-tlg. in 8 Modulen  
100 pcs. in 8 modules  
100 delig in 8 modules  
100 pces. en 8 modules  
100 pzs. en 8 módulos

Details siehe Seite  
Details see page  
Details zie pagina  
Presentoirs voir page  
Expositores,  
véase página

77-85



M 50829-4



M 50829-13



M 50829-5



M 50829-14

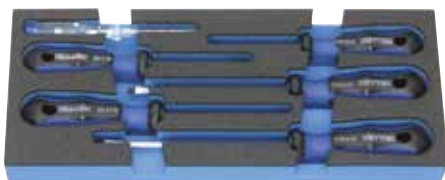

M 50829-8

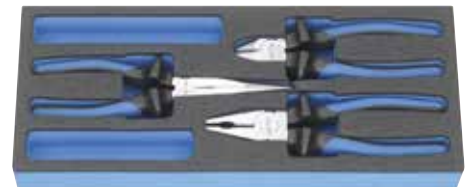

M 50829-15



M 50829-12



M 50829-16

Bestell-No./Order-No.	Art. No.	Maße · Dimensions					€
<b>50811292800</b>	5081129-28	M 50829-4	M 50829-5	M 50829-8	66910	1	<b>1.264,90</b>
		M 50829-12	M 50829-13	M 50829-14			
		M 50829-15	M 50829-16				

M 50829-50

M 50829-51 [www.heyco-qualitaetswerkzeuge.de](http://www.heyco-qualitaetswerkzeuge.de) **73**

## 5081130-...

Werkstattwagen  
mit Modulen

Workshop trolley  
with modules

Gereedschapswagen  
met modules

Servante d'atelier  
avec modules

Carro de herramientas  
con módulos



## 5081130-26

106-tlg./pcs./-dlg./pces./pzs.

106-tlg. in 2 Modulen

106 pcs. in 2 modules

106 delig in 2 modules

106 pces. en 2 modules

106 pzs. en 2 módulos

Details siehe Seite  
Details see page  
Details zie pagina  
Presentoirs voir page  
Expositores,  
véase página

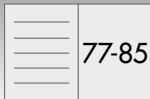

M 50829-50



M 50829-51

Bestell-No./Order-No.	Art. No.	Maße · Dimensions				€
<b>50811302600</b>	5081130-26	M 50829-50	M 50829-51	63800	1	<b>1.322,05</b>

## 5081130-27

132-tlg./pcs./-dlg./pces./pzs.

132-tlg. in 4 Modulen

132 pcs. in 4 modules

132 delig in 4 modules

132 pces. en 4 modules

132 pzs. en 4 módulos

Details siehe Seite  
Details see page  
Details zie pagina  
Presentoirs voir page  
Expositores,  
véase página

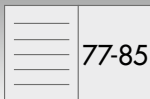

M 50829-50



M 50829-54



M 50829-51



M 50829-56

Bestell-No./Order-No.	Art. No.	Maße · Dimensions				€
<b>50811302700</b>	5081130-27	M 50829-50	M 50829-51	70180	1	<b>1.640,70</b>
		M 50829-54	M 50829-56			



**ZUBEHÖR**

- Papierkorb
- Papierrollenhalter
- Trennblech / Satz
- Fachteiler / Satz
- Ablageschale
- Dosenhalter

**ACCESSORIES**

- Waste-paper basket
- Paper roll holder
- Divider set for drawers
- Slotted divider set for drawers
- Storage box
- Tin holder



[www.heyco-qualitaetswerkzeuge.de](http://www.heyco-qualitaetswerkzeuge.de)  
HEYCO Art.-No. 1129-8-1 bis 12

**5081129-15**  
210 D PU Nylon

**Abdeckhaube  
für Werkstattwagen**

Preis und Lieferung ohne Werkstattwagen.

Nylon cover for  
workshop trolley

Price and delivery exclusive of tool trolley.

Afdekhoes voor  
gereedschapswagen

Prijs en levering zonder  
gereedschapswagen.



Protection pour  
servante d'atelier

Prix et livraison sans servante d'atelier.

Protección para  
carro de taller

Precio y suministro no incluyen el carro  
de taller.



Bestell-No./Order-No.	Art. No.	Maße · Dimensions			€
★ <b>50811291500</b>	5081129-15	(L) 730 x (B) 500 x (H) 850 mm	345	1	<b>23,20</b>

★ Auslauf / Discontinued

**1128-8-5**

6-tlg./pcs./-dlg./pces./pzs.

**Adapterset /  
Einlegetrennleisten**

Für HEYCO Werkstattwagen 1127  
+ 1128 zur Anpassung an HEYTEC  
Schaumstoffmodule.

Adaptor set /  
separation profiles

For HEYCO workshop trolleys 1127 +  
1128 for adaptation to HEYTEC-Foam  
modules.

Adapterset /  
verdeelschotten

Voor Heyco gereedschapswagens 1127  
+ 1128 voor aanpassing naar HEYTEC  
schuimstof module.



Assortiment d'adaptateurs/  
sectionneurs

Pour servantes d'atelier HEYCO 1127 +  
1128, pour l'adaptation des modules en  
mousse HEYTEC.

Juego de adaptadores/  
listones separadores

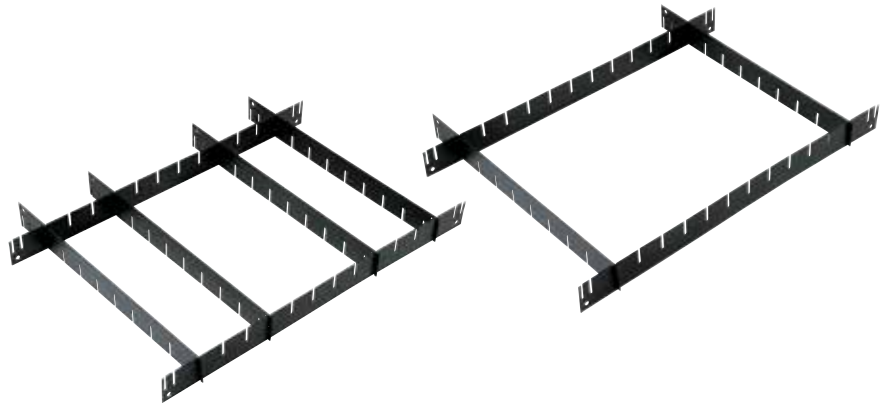
Para carro de taller HEYCO 1127 +  
1128, para adaptar a los módulos de  
poliuretano HEYTEC.



Bestell-No./Order-No.	Art. No.	Maße · Dimensions			€
<b>01128110200</b>	1128-8-5	560 x 410 x 45 mm	1410	1	<b>39,05</b>

### 5081129/5081130

Variable Bestückung  
der Schubladen  
mit Modulen

Variable assembly alternatives  
with modules

Variabele indeling  
van de schuifladen  
met modules

Equipement des tiroirs  
avec modules

Equipamiento de cajones  
con módulos

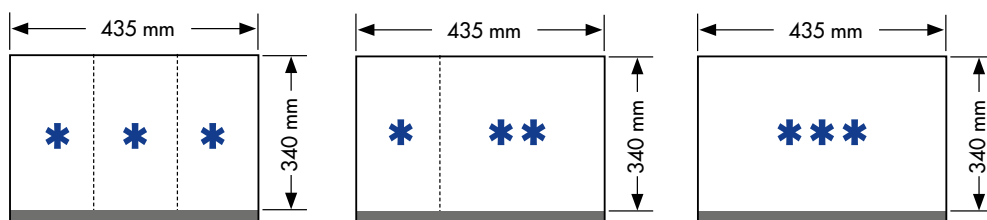

Hochwertiger 2-K Schaumstoff.  
High grade 2 components foam material.  
Hoogwaardig 2 componenten schuimstof.  
Module mousse de haute qualité bicolore.  
Plástico expandido de calidad 2-K.

### Modul \*\* M 50829-4

17-tlg./pcs./dlg./pces./pzs.

Ringmaulschlüssel-Satz

Mit Schonprofil, Doppelmodul.

Combination wrenches set  
With SP-profile, double module.

Ringsteeksleutelset

Met profiel bescherming, dubbele  
module.

Jeu de clés mixtes

Avec profil de protection, module double.

Juego de llaves combinadas

Con perfil especial SP, módulo doble.



enthaltend/containing



MM 6/7/8/9/10/11/  
12/13/14/15/16/  
17/18/19/20/21/22

Bestell-No./Order-No.	Art. No.	Maße · Dimensions			€
<b>50829000480</b>	M 50829-4	340 x 290 x 40 mm	4400	1	<b>98,30</b>

### Modul \* M 50829-3

10-tlg./pcs./dlg./pces./pzs.

Doppelmaulschlüssel-Satz

Double open ended jaw  
wrenches set

Ringsleutelset

Jeu de clés à fourche

Juego de llaves fijas de boca  
abierta



enthaltend/containing



MM 8x9 / 10x11 /  
12x13 / 14x15 /  
16x17 / 18x19 /  
20x22 / 21x23 /  
24x27 / 30x32

Bestell-No./Order-No.	Art. No.	Maße · Dimensions			€
<b>50829000380</b>	M 50829-3	340 x 145 x 40 mm	1832	1	<b>73,15</b>

**Modul \*  
M 50829-16**

8-tlg./pcs./dlg./pces./pzs.

**Doppelringschlüssel-Satz**

Tief gekröpft, mit Schonprofil.

Double ended ring wrenches set

Deep offset, profile saver.

Ringsleutelset

Diep gebogen, met profiel bescherming.

Clés polygonales coudées

Avec profil de protection des têtes de vis.

Llaves boca estrella acodadas  
Codo profundo, dentado con perfil SP.



enthaltend/containing



MM 6x7 / 8x9 /  
10x11 / 12x13 /  
14x15 / 16x17 /  
18x19 / 20x22

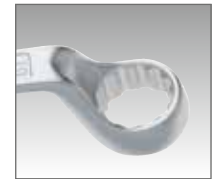

Bestell-No./Order-No.	Art. No.	Maße · Dimensions			€
<b>50829001680</b>	M 50829-16	340 x 145 x 40 mm	1250	1	<b>61,75</b>

**Modul \*  
M 50829-2**

13-tlg./pcs./dlg./pces./pzs.

**Knarren-Ringmaulschlüssel-Satz, umschaltbar**

Combination ratchet wrenches set, reversible

Ringratelsleutelset, omschakelbaar

Jeu de clés mixtes à cliquet réversible

Juego de llaves combinadas con carraca reversible



enthaltend/containing



MM 8/10/12/13/  
14/15/16/17/19/22



1/4" / 3/8" / 1/2"



Bestell-No./Order-No.	Art. No.	Maße · Dimensions			€
<b>50829000280</b>	M 50829-2	340 x 145 x 40 mm	1536	1	<b>276,10</b>

**Modul \*  
M 50829-9**

13-tlg./pcs./dlg./pces./pzs.

**Knarren-Ringmaulschlüssel-Satz**

Combination ratchet wrenches set

Ringratelsleutelset

Jeu de clés mixtes à cliquet

Juego de llaves combinadas con carraca



enthaltend/containing



MM 8/9/10/12/13/  
14/15/16/17/19



1/4" / 3/8" / 1/2"



Bestell-No./Order-No.	Art. No.	Maße · Dimensions			€
<b>50829000980</b>	M 50829-9	340 x 145 x 40 mm	1319	1	<b>217,05</b>

**Modul \*  
M 50829-13**

7-tlg./pcs./dlg./pces./pzs.

**Betätigungswerkzeug-Satz**

Accessories set

Hulpstukken set

Jeu d'accessoires

Juego de accesorios de accionamiento



enthaltend/containing



250 mm



250 mm



125 mm



75 mm



MM 16/20,8

Bestell-No./Order-No.	Art. No.	Maße · Dimensions			€
<b>50829001383</b>	M 50829-13	340 x 145 x 40 mm	1670	1	<b>96,40</b>

**Modul \*  
M 50829-12**

20-tlg./pcs./-dlg./pces./pzs.

**Steckschlüssel-Satz**

Socket set

Dopsleutelset

Jeu de douilles

Juego de llaves de vaso



enthaltend/containing	
$\varnothing$ 40 mm	MM 10/11/12/13/ 14/15/16/17/ 18/ 19/20/21/22/24/ 27/30/32
$\varnothing$ 75 mm	MM 13/17/19

Bestell-No./Order-No.	Art. No.	Maße · Dimensions			€
<b>50829001283</b>	M 50829-12	340 x 145 x 40 mm	1974	1	<b>96,40</b>

**Modul \*  
M 50829-10**

IEC 60900

DIN 7437 · DIN 7438 PZ

6-tlg./pcs./-dlg./pces./pzs.

**VDE-Schraubendreher-Satz**

Mit umspritzter Klinge-isolierung

VDE-Screwdriver set

Insulation of blade and handle injection moulded as one unit.

VDE schroevendraaierset

Met klingenspoten isolatie.

Jeu de tournevis VDE

Avec isolation de la lame par injection.

Juego de destornilladores VDE

Varillas con aislamiento inyectado.

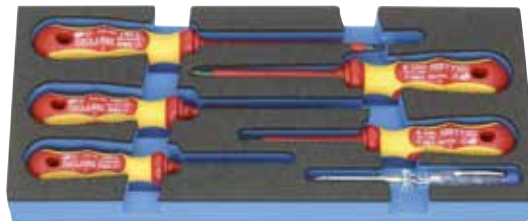

enthaltend/containing	
	150 - 250 V
	MM 2,5x75 / 4x100 / 5,5x125
	PZ 1 / PZ 2

mit 2K-Griff  
with 2 components plastic handles  
met 2 componenten greep  
avec poignée à 2 composantes  
con mango de dos componentes

Bestell-No./Order-No.	Art. No.	Maße · Dimensions			€
<b>50829001033</b>	M 50829-10	340 x 145 x 40 mm	583	1	<b>61,75</b>

**Modul \*  
M 50829-14**

36-tlg./pcs./-dlg./pces./pzs.

**Steckschlüssel-Satz**

Socket set

Dopsleutelset

Jeu de douilles

Juego de llaves de vaso



enthaltend/containing	
	150 mm
	150 mm
	50 + 100 mm
	37 mm
$\varnothing$ 25 mm	MM 4/4,5/5/6/7/ 8/ 9/10/11/12/13
$\varnothing$ 50 mm	MM 6/7/8/9/10/ 11/12/13
	PZ 1 / PZ 2
	3/4/5/6
	0,8x4 / 1x5,5
	TT15 / TT20 / TT25 / TT30

Bestell-No./Order-No.	Art. No.	Maße · Dimensions			€
<b>50829001483</b>	M 50829-14	340 x 145 x 40 mm	1025	1	<b>110,00</b>

**Modul \*  
M 50829-17**

24-tlg./pcs./-dlg./pces./pzs.

**Schraubendrehereinsatz-  
Sortiment**

Screwdriver socket set

Schroevendraaiet dopsleutelset

Composition de douilles-  
tournevis

Conjunto de llaves de vaso  
con destornillador

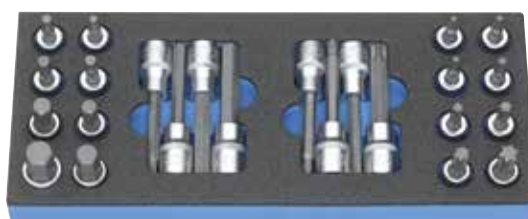

enthaltend/containing	
$\varnothing$ 62 mm	5/6/7/8/10/12/14/17
$\varnothing$ 62 mm	T 25/27/30/40/45/50/55/60
$\varnothing$ 100 mm	6/8/10/12
$\varnothing$ 100 mm	T 30/40/50/60

Bestell-No./Order-No.	Art. No.	Maße · Dimensions			€
<b>50829001783</b>	M 50829-17	340 x 145 x 40 mm	2525	1	<b>142,10</b>

**Modul \*  
M 50829-11**

5-tlg./pcs./-dlg./pces./pzs.



**Radwechsel-Satz**

Bestehend aus 3 Impact-Einsätzen mit Kugelfangbohrung, inkl. Kunststoffhülsen zum Schutz von Alufelgen, Kunststoffschaber.

Tools for wheel changing set  
Consisting of 3 impact sockets with ball retaining groove, including plastic sleeves for protecting alloy rims, plastic scraper.

**Wielmoersleutelset**

Bestaande uit 3 krachtdoppen met kogelvangsleuf, incl. kunststof hulzen, ter bescherming van aluminium velgen, kunststof schraper.

**Jeu pour écrous de roues**

Composé de 3 douilles impact avec trou pour bille et manchon plastique de protection des jantes en aluminium, racloir en plastique.

**Juego de herramientas para cambio de ruedas**

Con 3 llaves de vaso de impacto con agujero para fijación, incluidos protectores de plástico para no dañar llantas de aluminio, rascador de plástico.



enthaltend/containing	
	85 mm MM 17/19/21
	280 mm
	285 mm

Bestell-No./Order-No.	Art. No.	Maße · Dimensions			€
<b>50829001100</b>	M 50829-11	340 x 145 x 40 mm	842	1	<b>66,30</b>

**Modul \*  
M 50829-5**

3-tlg./pcs./-dlg./pces./pzs.

**Zangenmodul mit Schlosserhammer**

Pliers and hammer set

Tangenmodule met bankhamer

Pince multiprise et pince-étou

Juego de 3 pzs.



enthaltend/containing	
	300 g
	250 mm
	235 mm

Bestell-No./Order-No.	Art. No.	Maße · Dimensions			€
<b>50829000500</b>	M 50829-5	340 x 145 x 40 mm	1325	1	<b>55,40</b>

**Modul \*  
M 50829-15**

3-tlg./pcs./-dlg./pces./pzs.

**Zangen-Satz**

Kombinationszange, gerade Flachrundzange, Seitenschneider schwedische Form, mit Kunststoffhandschutz.

Pliers set

Combination plier, snipe nose plier, diagonal cutting nipper, with plastic handle.

Zangenset

Combinatietang, telefoontang recht, zijsnijtang zweeds model, met kunststof greep.

Jeu de pinces

Pince universelle, pince à becs demi-ronds, droite, pince coupante diagonale modèle suédois, avec gaine plastique.

Conjunto de 3 alicates

Alicate universal alicate de radio recto cortalambres modelo sueco, con fundas de plástico.

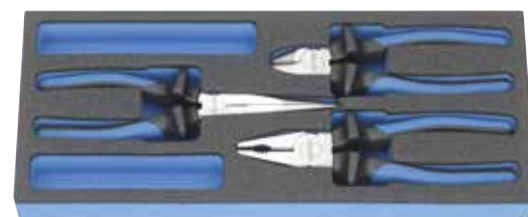

enthaltend/containing	
	180 mm
	200 mm
	160 mm

Bestell-No./Order-No.	Art. No.	Maße · Dimensions			€
<b>50829001542</b>	M 50829-15	340 x 145 x 40 mm	715	1	<b>62,70</b>



**Modul \***  
**M 50829-8**

6-tlg./pcs./-dlg./pces./pzs.

**Schraubendreher-Satz  
mit 2K-Griff**

Screwdriver set

Schroevendraaierset met  
2 componenten greep

Jeu de tournevis avec poignée  
bimatière

Juego de destornilladores con  
mango de dos componentes



enthaltend/containing	
	150 - 250 V
	MM 4x75 5,5x125 6,5x150
	PH 1 / PH 2

Bestell-No./Order-No.	Art. No.	Maße - Dimensions			€
<b>50829000880</b>	M 50829-8	340 x 145 x 40 mm	553	1	<b>46,95</b>

**Modul \***  
**M 50829-19**

IEC 900/DIN EN 60900  
3-tlg./pcs./-dlg./pces./pzs.

**VDE-Zangen-Satz**

Köpfe geschliffen und lackiert, Griffe  
mit 2-K Isoliergriffen. Schneide für  
mittelharten Draht.

VDE Pliers set

Heads ground and lacquered with 2 K  
insulated handle, cutting edges for  
middlehard wire.

VDE tangenset

Kop gepolijst en gelakt, grepen met  
2 componenten isolatiegreep, knipt  
middelharde draad.

Jeu de pinces VDE

Chromées et laquées, poignées gainées  
isolées bimatière, pour fil de dureté  
moyenne.

Conjunto de 3 alicates, VDE  
Cabeza amolada y barnizada, mangos  
con fundas aislantes 2K, cortante para  
alambre semi-duro.



enthaltend/containing	
	180 mm
	200 mm
	160 mm

Bestell-No./Order-No.	Art. No.	Maße - Dimensions			€
<b>50829001986</b>	M 50829-19	340 x 145 x 40 mm	710	1	<b>96,40</b>

**Modul \*\*\***  
**M 50829-18**

IEC 60900,  
DIN 7437/DIN 7438 PZ  
12-tlg./pcs./-dlg./pces./pzs.

**VDE-Werkzeugsortiment**

In 2-K Schaumstoffeinlage.

VDE Tool set

With 2 components foam insert.

VDE schroevendraaierset

Met 2 componenten greep.

Sélection d'outillage VDE

Sur plateau mousse bicolore.

Conjunto de herramientas VDE

Con material de espuma 2 componentes  
alta gama.



enthaltend/containing	
	180 mm
	160 mm
	200 mm
	160 mm
	200 mm
	115 - 195 mm
	150 - 250 V
	MM 0,4 x 2,5 x 75 / 0,8 x 4,0 x 100 / 1,0 x 5,5 x 125
	PZ 1 / PZ 2

mit 2K-Griff  
with 2 components plastic handles

Bestell-No./Order-No.	Art. No.	Maße - Dimensions			€
<b>50829001800</b>	M 50829-18	435 x 340 x 35 mm	2910	1	<b>239,80</b>

**Modul \*\*\*  
M 50829-50**

36-tlg./pcs./-dlg./pces./pzs.

**Schlüssel-Satz**

Mit Schonprofil, Doppelmodul.

Combined wrenches set  
With SP-profile, double modul.

Leutelset

Met profiel bescherming, dubbele module.

Jeu de clés mixtes

Avec profil de protection, module double.

Juego de llaves combinadas

Con perfil especial SP, módulo doble.



enthaltend/containing	
	MM 6/7/8/9/10/11/12/ 13/14/15/16/17/18/ 19/20/21/22/24
	MM 6x7/ 8x9 / 10x11 / 12x13 / 14x15 / 16x17 / 18x19 / 20x22
	MM 6x7 / 8x9 / 10x11 / 12x13 / 14x15 / 16x17 / 18x19 / 20x22 / 24x27
	205 mm / 0 - 30 mm

Bestell-No./Order-No.	Art. No.	Maße · Dimensions			€
<b>50829005000</b>	M 50829-50	435 x 340 x 35 mm	4500	1	<b>233,50</b>

**Modul \*\*\*  
M 50829-51**

70-tlg./pcs./-dlg./pces./pzs.

**Kombinierter Steckschlüssel-Satz**

Combined socket set

Gecombineerde Dopsleutelset

Composition de douilles

Conjunto de llaves de vaso



enthaltend/containing	
	150 + 250 mm
	150 mm
	37 + 75 mm
	250 mm
	50 + 100 + 125 mm
CL 25 mm	MM 4/4,5/5/5,5/6/ 7/8/ 9/10/11/12/13
CL 50 mm	MM 6/7/8/9/10/ 11/12/13
CL 40 mm	MM 10/11/12/13/14/ 15/16/17/18/19/20/ 21/22/24/27/30/32
CL 75 mm	MM 10/13/14/15/ 17/19/22
CL 65 mm	MM 16/20,8
PZ 1 / PZ 2  3/4/5/6  0,8x4 / 1x5,5	
	TT 10/15/20/25/ 27/30/40

Bestell-No./Order-No.	Art. No.	Maße · Dimensions			€
<b>50829005100</b>	M 50829-51	435 x 340 x 35 mm	4710	1	<b>315,15</b>

**Modul \*\*\*  
M 50829-52**

48-tlg./pcs./-dlg./pces./pzs.

**Schraubendrehereinsatz  
Sortiment**

Screwdriver socket set

Schroevendraaier dopsleutelset

Composition de douilles-  
tournevis

Conjunto de llaves de vaso  
con destornillador



enthaltend/containing	
CL 62 mm	5/6/7/8/10/12/14/17
CL 100 mm	6/8/10/12/14
CL 62 mm	M5 / M6 / M8 / M10
CL 62 mm	T 20/25/27/30/40/45/ 50/55/60
CL 100 mm	M 6/8/10/12
CL 100 mm	T 30/40/50/60
CL 38 mm	E 10/11/12/14/16/18/ 20/22/24
CL 62 mm	M5 / M6 / M8 / M10 / M12

Bestell-No./Order-No.	Art. No.	Maße · Dimensions			€
<b>50829005200</b>	M 50829-52	435 x 340 x 35 mm	4630	1	<b>284,20</b>



**Modul \*\*\***  
**M 50829-53**

17-tlg./pcs./dlg./pces./pzs.

**Steckschlüssel-Satz**

Socket set

Dopsleutelset

Jeu de douilles

Juego de llaves de vaso



enthaltend/containing	
	510 mm
	455 mm
	3/4" - 1/2"
	100 + 200 + 400 mm
	40 mm MM 19/22/24/27/30/32/36
	HW 14/17/19/22

Bestell-No./Order-No.	Art. No.	Maße · Dimensions			€
<b>50829005300</b>	M 50829-53	435 x 340 x 35 mm	8800	1	<b>414,00</b>

**Modul \*\*\***  
**M 50829-54**

10-tlg./pcs./dlg./pces./pzs.

**Zangen-Satz**

Pliers set

Zangenset

Jeu de pinces

Conjunto de 10 alicates



enthaltend/containing	
	250 mm
	230 mm
	260 mm
	235 mm
	200 mm
	180 mm
	200 mm
	160 mm
	Gr. 18 mm inkl. Ersatzklingen / incl. Spare blades

Bestell-No./Order-No.	Art. No.	Maße · Dimensions			€
<b>50829005400</b>	M 50829-54	435 x 340 x 35 mm	2870	1	<b>219,45</b>

**Modul \*\*\***  
**M 50829-55**

35-tlg./pcs./dlg./pces./pzs.

**Schraubendreher-Satz  
mit 2K-Griff**

Screwdriver set

Schroevendraaierset met  
2 componenten greep

Jeu de tournevis avec poignée  
à 2 composants

Juego de destornilladores con  
mango de dos componentes



enthaltend/containing	
	150 - 250 V
	MM 4x75 / 5,5x125 / 6,5x150
	PH 1 / PH 2
	T 15/20/25/27/30/40 MM 8/6/5/4/3
	T 10/15/20/25/27 30/40/45/50 MM 1,5/2/2,5/3/ 4/5/6/8/10

Bestell-No./Order-No.	Art. No.	Maße · Dimensions			€
<b>50829005500</b>	M 50829-55	435 x 340 x 35 mm	1800	1	<b>191,60</b>

**Modul \*\*\*  
M 50829-56**

16-tlg./pcs./dlg./pces./pzs.

**Kombinierter Werkzeug-Satz**

Combination tool set

Gecombineerde gereedschapset

Ensemble d'outils combinés

Set de herramientas combinadas



enthaltend/containing	
	1000 g
	300 g
	Ø 35
	200 mm
	Ø 3 x 120 mm
	Ø 5 x 150 mm
	Ø 3 x 120 mm
	5 x 130 mm
	12 x 130 mm
	14 x 150 mm

Bestell-No./Order-No.	Art. No.	Maße · Dimensions			€
<b>50829005600</b>	M 50829-56	435 x 340 x 35 mm	3500	1	<b>203,85</b>

**Modul \*\*\*  
M 50829-57**

17-tlg./pcs./dlg./pces./pzs.

**Werkzeug-Satz „KFZ“**

Vehicle tool set

Gereedschapset "KFZ",

Composition automobile

Conjunto de herramientas "KFZ"



enthaltend/containing	
	CL 85 mm MM 17/19/21
	CL 150 mm MM 17/19/21
	280 mm
	400 mm
	290 mm
	CL 75 mm MM 16/20,8
	84 mm
	0-60 mm
	260 mm
	40 - 200 Nm

Bestell-No./Order-No.	Art. No.	Maße · Dimensions			€
<b>50829005700</b>	M 50829-57	435 x 340 x 35 mm	4200	1	<b>431,30</b>





## 50881-6

28-tlg./pcs./-dlg./pces./pzs.

### Werkzeugkasten „JUNIOR“

Mit Sortiment, 28-tlg.  
Stahlblech, lackiert.

### Tool box „JUNIOR“

With 28 pcs. assortment  
sheet steel, lacquered.

### Gereedschapskist „JUNIOR“

Met assortiment, 28-delig.  
Plaatstaal, gelakt.

### Boîte à outils „JUNIOR“

Avec assortiment d'outils 28 pces.  
en tôle d'acier, peint.



### Caja herramientas „JUNIOR“

Con surtido de 28 pzs.  
en chapa de acero lacado.



enthaltend/containing

	MM 6x7/ 8x9 / 10x11 / 12x13 / 14x15 / 16x17 / 18x19 / 20x22		500 g
	MM 4,0 x 75 5,5 x 125 / 6,5 x 150		MM 1,5/2/2,5/3/ 4/5/6/8/10
	PH 1 / 2		TX 10/15/20/25/ 27/30/40/45/50
	150 - 250 V		155 mm / 6" Nonius 1/20 mm / 1/128"
	160 mm		Gr. 18 mm
	230 mm		3 m
	250 mm		230 mm
	200 mm		
	200 mm		CE/EN 388-4131

Bestell-No./Order-No.	Art. No.	Maße · Dimensions			€
<b>50881000600</b>	50881-6	430 x 185 x 200 mm	8400	1	<b>263,55</b>

## 98076-08

5-tlg./pcs./-dlg./pces./pzs.

### Montage-Werkzeugkasten, leer

Stahlblech, in Hammerschlagblau.

Tool box, cantilever type,  
empty

Sheet steel, hammertone blue.

### Gereedschapskist, leeg

Plaatstaal, in blauw hamerslag lak.



### Boîte à outils, vide

En tôle d'acier couleur bleu martelé.

### Caja de herramientas, vacío

En chapa de acero, pintada en azul.



Bestell-No./Order-No.	Art. No.	Maße · Dimensions			€
<b>98076080020</b>	98076-08	530 x 200 x 200 mm	3250	1	<b>73,05</b>





**508076-945**

96-tlg./pcs./-dlg./pces./pzs.

**Montage-Werkzeugkasten mit 5 Modulen**

Tool box, cantilever type with 5 modules

Gereedschapskist met 5 modules

Boîte à outils avec 5 modules

Caja de herramientas con 5 módulos



**HEYTEC**  
BESTSELLER

enthaltend/containing

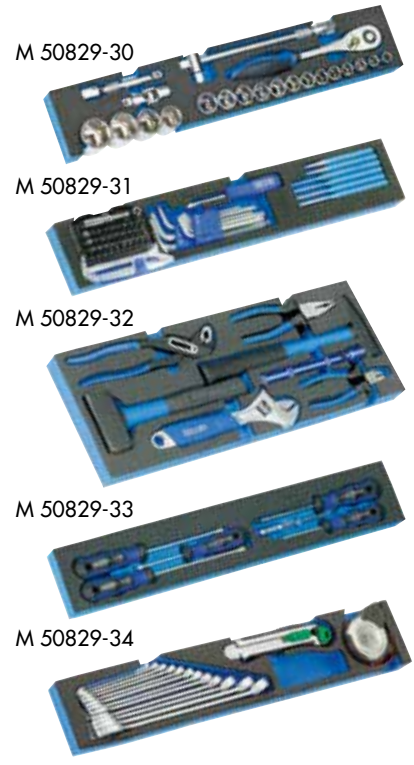

Bestell-No./Order-No.	Art. No.	Module - Modules					€
<b>50807694500</b>	508076-945	M 50829-30	M 50829-31	M 50829-32	14430	1	<b>523,95</b>
		M 50829-33	M 50829-34				

**M 50829-30**

21-tlg./pcs./-dlg./pces./pzs.

**Werkzeugmodul**

Tool module

Gereedschapsmodule

Module avec outils

Módulo con herramientas

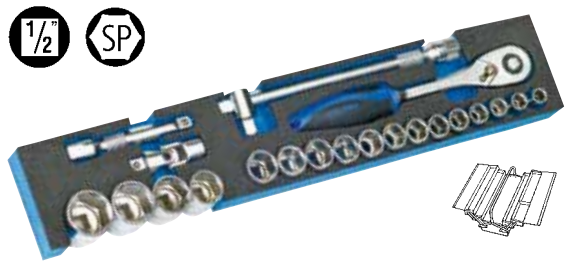

enthaltend/containing



Bestell-No./Order-No.	Art. No.	Module - Modules			€
<b>50829003083</b>	M 50829-30	528 x 98 x 35 mm	2954	1	<b>135,70</b>

**M 50829-31**

48-tlg./pcs./-dlg./pces./pzs.

**Werkzeugmodul**

Tool module

Gereedschapsmodule

Module avec outils

Módulo con herramientas

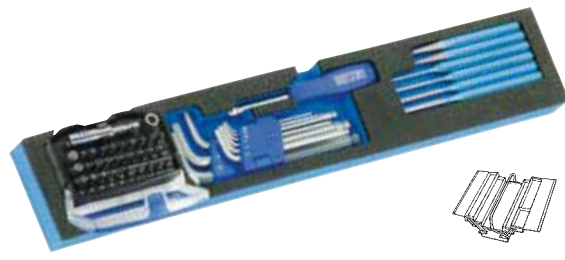

enthaltend/containing



50833-2  
siehe Seite 36/  
see page 36

Bestell-No./Order-No.	Art. No.	Module - Modules			€
<b>50829003100</b>	M 50829-31	528 x 98 x 35 mm	1063	1	<b>85,75</b>



### M 50829-32

7-tlg./pcs./dlg./pces./pzs.

#### Werkzeugmodul

Tool module

Gereedschapsmodul

Module avec outils

Módulo con herramientas

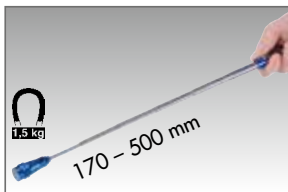

enthaltend/containing

	1000 g
	300 g
	170 - 500 mm
	180 mm
	250 mm
	160 mm
	255 mm

Bestell-No./Order-No.	Art. No.	Module - Modules			€
<b>50829003200</b>	M 50829-32	528 x 195 x 35 mm	3040	1	<b>138,70</b>

### M 50829-33

6-tlg./pcs./dlg./pces./pzs.

#### Werkzeugmodul

Tool module

Gereedschapsmodul

Module avec outils

Módulo con herramientas

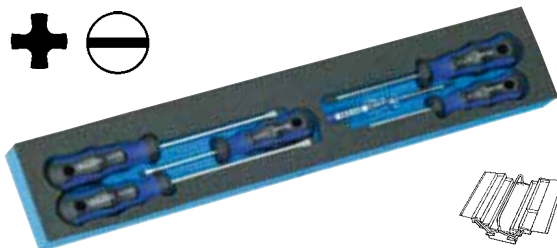

enthaltend/containing

	0,75 x 3,0 x 60 mm
	4,0 x 75 mm
	5,5 x 125 mm
	6,5 x 150 mm
	PH 1 / PH 2

Bestell-No./Order-No.	Art. No.	Module - Modules			€
<b>50829003380</b>	M 50829-33	528 x 98 x 35 mm	483	1	<b>53,00</b>

### M 50829-34

14-tlg./pcs./dlg./pces./pzs.

#### Werkzeugmodul

Tool module

Gereedschapsmodul

Module avec outils

Módulo con herramientas

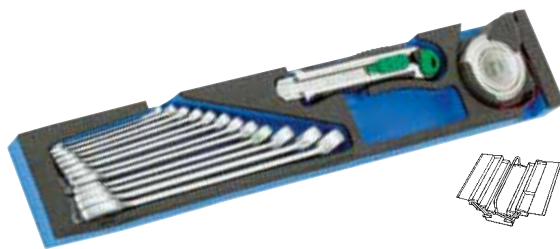

enthaltend/containing

	MM 8/10/11/12/ 13/14/15/16/17/ 19/22/24
	170 mm
	5 m

Bestell-No./Order-No.	Art. No.	Module - Modules			€
<b>50829003480</b>	M 50829-34	528 x 98 x 35 mm	1888	1	<b>85,75</b>

### M 50829-35

16-tlg./pcs./dlg./pces./pzs.

#### Austauschmodul für Montage-Werkzeugkasten

Exchange modul  
for tool box set

Extra module voor  
mantage gereedschapskist

Module alternatif pour  
boîte à outils pour monteurs

Módulo intercambiable  
para caja de herramientas

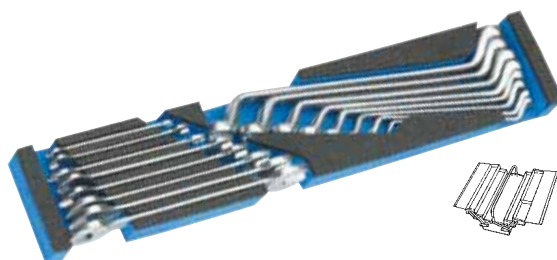

enthaltend/containing

	MM 6x7/8x9/10x11/ 12x13/14x15/16x17/ 18x19/20x22
	MM 6x7/8x9/10x11/ 12x13/14x15/16x17/ 18x19/20x22

Bestell-No./Order-No.	Art. No.	Module - Modules			€
<b>50829003580</b>	M 50829-35	528 x 98 x 35 mm	1960	1	<b>80,70</b>

**508201-762**

Einfache Klickverbindung. Modularer Innenraum. Einzigartiges Mobilitätssystem. Beliebig erweiterbar. Crashesicherer Transport. Aus schlag- und stoßfestem ABS-Kunststoff. Ergonomisch geformten Griffe, zusätzliche seitliche Griffschalen sowie praktische Schlaufen garantieren ein flexibles und komfortables Handling. Der Deckel ist bis 100 kg belastbar, spritzwassergeschützt.

Robust click mechanism. Modular interior. Expandable as desired. Unique mobility system. Crash Safe transport. Made of impact and shock resistant ABS plastic. Ergonomically shaped handles and additional side grips for flexible and convenient handling. The lid can hold a load of up to 100 kg, spray-water protected.



**508201-762**

97-tlg./pcs./dlg./pces./pzs.

**Montage-Werkzeugsortiment**

L-BOXX® Module mit 97 Werkzeugen.  
Beladungskapazität pro Box bis zu 25 kg. Transport der Boxen im Verbund bis 40 kg.

Construction tool set  
L-BOXX® Modules with 97 tools.  
Loading capacity of up to 25 kg.  
Transported in bundles up to 40 kg.

Montage gereedschapset  
L-BOXX® modulemet 97 stuks gereedschap. Koffer belastbaar tot 25 kg. Bij gekoppelde koffers belastbaar tot 40 kg.

Assortiment d'outils  
d'assemblage

Module L-BOXX® avec 97 outils.  
Capacité de chargement par boîte jusqu'à 25 kg. Transport des boîtes en cumulé jusqu'à 40 kg.

Conjunto de herramientas de  
montaje

L-BOXX® Módulos con 97 herramientas.  
Capacidad de carga por conjunto hasta 25 kg. Transporte de las cajas en conjunto hasta 40 kgs.



Bestell-No./Order-No.	Art. No.	Maße - Dimensions	Module - Modules	g	g	€
<b>50820176200</b>	508201-762	442 x 357 x 151 mm	50807696100 50807696200	11690	1	<b>676,40</b>

**50876-961**

77-tlg./pcs./dlg./pces./pzs.

**Montage-Werkzeugsortiment für L-BOXX®**

Construction tool set for  
L-BOXX®

Montage gereedschapset  
voor L-BOXX®

Assortiment d'outils de montage  
pour L-BOXX®

Caja herramientas para  
L-BOXX®



enthaltend/containing

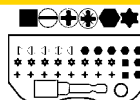

50833-2  
siehe Seite 36/see page 36

- 255 mm
- 250 mm     125 mm
- 250 mm
- 75 mm
- MM 1,5/2/2,5/3/4/5/6/8/10
- 200 mm     230 mm
- MM 8/10/11/12/13/14/  
15/16/17/19/22/24
- MM 10/11/12/13/14/15/16/17/  
18/19/20/21/22/24/27/30/32

Bestell-No./Order-No.	Art. No.	Maße - Dimensions	g	g	€
<b>50807696100</b>	50876-961	405 x 310 x 50 mm	5910	1	<b>350,50</b>

**50876-962**

20-tlg./pcs./dlg./pces./pzs.

**Montage-Werkzeugsortiment für L-BOXX®**

Construction tool set for  
L-BOXX®

Montage gereedschapset  
voor L-BOXX®

Assortiment d'outils de montage  
pour L-BOXX®

Caja herramientas para  
L-BOXX®



enthaltend/containing

- 150 - 250 V
- 0,8 x 4,0 x 75 mm / 1,0 x 5,5 x 125 mm  
/ 1,2 x 6,5 x 150 mm
- PH 1 / PH 2
- 3 m     Gr. 18 mm
- 1000 g     300 g
- 250 mm
- 180 mm     160 mm
- 170 - 500 mm

Bestell-No./Order-No.	Art. No.	Maße - Dimensions	g	g	€
<b>50807696200</b>	50876-962	405 x 310 x 40 mm	5110	1	<b>218,15</b>

508675

134-tlg./pcs./dlg./pces./pzs.



### Montage-Werkzeugkoffer

Mit 4 Modulen.

Hochwertiger ABS-Schalenkoffer mit Werkzeugtafeln und 2-K Schaumstoffeinlage.

**Ausstattungsmerkmale:**

- Schlagfestes ABS-Material
- Umlaufender Stoßkantenschutz
- Hochwertige Metallschlösser
- Stabiler und gehärteter Aluminiumrahmen
- Ergonomischer Tragegriff
- Drei Metallscharniere
- Stabiler Deckelhalter

### Construction tool case

With 4 modules.

Premium-quality ABS-Shell case with tool- and 2-K foam inlays.

**Features:**

- Impact-proof ABS-material
- Circumferential abutting edge-protection
- Premium-quality metal locks
- Stable and hardened aluminium frame
- Ergonomic carrying handle
- Three metal hinges
- Stable lid holder



### Montage gereedschapskoffer

Met 4 modules.

Hoogwaardige ABS koffer met gereedschapbladenen 2 componenten schuimstofinleg.

**Uitgerust met:**

- Slagvast ABS
- rondom uitgevoerd met beschermerand
- hoogwaardige metalen sloten
- robuust en gehard aluminium frame
- ergonomische greep
- drie metalen scharnieren
- robuuste dekselscharnieren

### Valise à outils

Avec 4 modules.

Boîtier ABS de haute qualité avec plateau d'outils et deux inserts en mousse 2 composants.

**Caractéristiques:**

- Matériel ABS autour de la valise
- Pare-chocs autour du coffret
- Serrures métalliques de haute qualité
- Cadre en aluminium stable et dur
- Poignée ergonomique
- Trois charnières métalliques
- Support à couvercle robuste



### Cofre de herramientas para montadores

Con 4 módulos.

Maleta de plástico ABS con bandejas de herramientas y forro de dos componentes.

**Características del equipamiento:**

- Plástico tipo ABS- cantos protegidos
- Umlaufender Stoßkantenschutz
- Cerraduras metálicas de calidad
- Armazón robusto y templado de aluminio
- Asa hergónómica
- 3 bisagras metálica
- Sujeción de la tapa reforzada

enthaltend/containing	
	MM 8/10/11/12/13/14/15/16/17/19/22/24
	Geprüft nach DIN EN 166 F
	9" / CE/EN 388-4131
	150 - 250 V
	170 - 500 mm
	MM 4,0 x 75 / 5,5 x 125 / 6,5 x 150
	PH 1 / 2
	200 mm
	200 mm Gr. 18 mm
	250 mm
	180 mm
	160 mm
	MM 1,5/2/2,5/3/4/5/6/8/10
	TX 10/15/20/25/27/30/40/45/50
	205 mm
	3 m
	200 mm
	500 g
	230 mm
	200 mm
	200 mm
	250 mm
	250 mm
	125 mm
	MM 10/11/12/13/14/15/16/17/18/19/20/21/22/24/27/30/32
	75 mm
	■ R1 - R2    ⊖ 3,5 - 8    ● 2 - 8
	+ PH 1 - 3    * PZ 1 - 3    * TT 9 - 40
	115 mm    100 mm    125 mm
	* TT 10-40    + PH 2    ● 5/6    * PZ 2
	MM 4/4,5/5,5/6/7/8/9/10/11/12/13
	∅ 3 x 120 mm    5 x 130 mm
	∅ 5 x 150 mm    12 x 130 mm
	∅ 3 x 120 mm    14 x 150 mm

Bestell-No./Order-No.	Art. No.	Maße · Dimensions			€
5086750000	508675	460 x 370 x 170 mm	13300	1	792,80

### 50807-92

92-tlg./pcs./dlg./pcs./pzs.



## Montage-Werkzeugsortiment in Umhängetasche

Hochwertige Aufbewahrungstasche mit Klemmhaltesystem sowie Einsteckfächern für Werkzeuge aller Art.

#### Ausstattungsmerkmale:

- Gepolsterter Trageriemen
- Robuster Tragegriff
- Ausklappbarer Stellfuß für sicheren Stand
- Kleinteilmagazin
- Geschütztes, gepolstertes Laptop-Fach
- Zusätzliches Fach für Dokumente

## Tool assortment in shoulder bag

Premium-quality storage bag with locking system and compartments for all kinds of tools.

#### Features:

- Cushioned carrying strap
- Robust carrying handle
- Fold-out foot for a secure stand
- Small parts magazine
- Protected, cushioned laptop-compartment
- Additional compartment for documents

## Gereedschapstas

Hoogwaardige gereedschapstas met gereedschapsklemmen en insteekvakken voor allerhande gereedschappen.

#### Uitgerust met:

- Gepolsterde draagriem
- Robuuste draaggreep
- Uitklapbare stelvoet
- Vakkeendoos voor kleine materialen
- Beschermd, gepolsterd laptopvak
- Extra vak voor documenten

## Sélection d'outils en sacoche textile

Sacoche de rangement de haute qualité avec système de serrage, ainsi que des poches pour tous types d'outils.

#### Caractéristiques:

- Bandoulière rembourrée
- Poignée de transport robuste
- Béquille intégrée pour plus de stabilité
- Pour petites pièces
- Protégé, compartiment rembourré pour ordinateur portable
- Compartiments à documents

## Conjunto de herramientas en cartera para herramientas

Cartera de calidad, con pinzas y bolsillos para guardar herramientas de todo tipo.

#### Características del equipamiento:

- Correa acolchada
- Asa robusta
- Pie plegable para una colocación segura
- Recipiente para piezas pequeñas
- Compartimento acolchado para lap-top
- Compartimento adicional para documentos



**HEYTEC**  
BESTSELLER

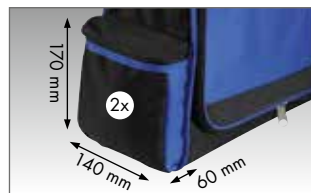
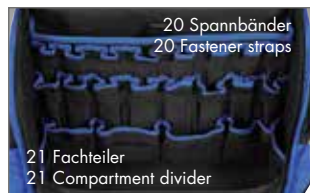

#### enthaltend/containing

5 m	170 - 500 mm
250 mm	Geprüft nach DIN EN 166 F
MM 8/9/10/11/13/14/17/19	230 mm
180 mm	MM 4,0 x 75 / 5,5 x 125 / 6,5 x 150
160 mm	PH 1 / 2
MM 1,5/2/2,5/3/4/5/6/8/10	150 mm
150 - 250 V	R1 - R2 3,5 - 8 2 - 8
300 g	PH 1 - 3 PZ 1 - 3 TT 9 - 40
150 mm	205 mm
150 mm, Stahl, 10 Stk./pcs.	250 mm
Gr. 18 mm	125 mm
	MM 8/10/11/13/ 15/17/18/19/22/24
	MM 20,8

Bestell-No./Order-No.	Art. No.	Maße · Dimensions			€
<b>50807892000</b>	50807-92	555 x 410 x 180 mm	9500	1	<b>566,30</b>

508201-762

Robuster Tragegrif. Zusätzlicher Deckel zum Schutz vor Nässe. Rutschfeste, gummierte Bodenplatte. Sicherheitsreflektoren, robuste Aufhängeösen. Rückenbereich ergonomisch gepolstert.

Robust carrying handle. Additional wetness protection cover. Gummed non-slip bottom slab. Safety reflectors, robust suspension hooks. Ergonomically cushioned back.





## 5081052

### Rucksack für Werkzeugsortimente, leer

Hochwertiger Rucksack mit separater Innentasche für Werkzeuge aller Art.

**Ausstattungsmerkmale:**

- Gepolsterte Schultergurte mit Handytasche
- Netz-Außentaschen
- Seitentasche mit Fach für Visitenkarten
- Elastische Halteriem
- Separate Werkzeugtasche
- Viele Einsteck- und Klemmhaltemöglichkeiten
- Innenfächer für Schreibunterlagen/ Laptop/Tablet
- Robuste und stabile Bauform mit vielen Extras
- Hoher Tragekomfort, ergonomische Form

### Backpack for tool set, empty

High quality backpack with separate inner pocket for all kinds of tools.

**Features:**

- Upholstered shoulder belts with cell phone pocket
- Outside mesh pockets at the front and on one side
- Side pocket with business card holder
- Elastic holding straps
- Separate tool bag for convenient removal
- Multiple storage- and locking-compartments
- Interior compartments for writing pads/ laptop/tablet PC
- Robust and sturdy design with various extras
- Excellent wearing comfort, ergonomic shape



### Rugzak voor gereedschapsets, leeg

Hoogwaardige rugzak met apart binnenvak voor diverse gereedschappen.

**Uitgerust met:**

- Gepolsterde schouderbanden met gsm-vakje
- Gaas-vakken aan de buitenkant
- Zijvak met ruimte voor visitekaartjes
- Elastische sluitriemen
- Aparte gereedschapstas
- Veel insteek- en klemmogelijkheden
- Binnenvakken voor schrijfbenodigdheden/ laptop/tablet
- Robuust ontwerp met vele extra's
- Uitstekend draagcomfort, ergonomische vorm



### Sac à dos vide pour assortiment d'outillage

Sac à dos de haute qualité avec poche intérieure séparée pour toutes sortes d'outils.

**Caractéristiques:**

- Bretelles rembourrées avec poche pour téléphone cellulaire
- Poches extérieures devant et sur un côté
- Poche latérale pour cartes de visite
- Alvéoles élastiques
- Sac à outils séparé pour enlèvement facile
- Plusieurs compartiments de stockage et de verrouillage
- Compartiment intérieur pour ordinateur portable/tablette PC
- Design robuste avec de nombreux extras
- Confort excellent et forme ergonomique



### Mochila para juego de herramientas, vacía

Mochila de alta calidad con bolsillo interior separado, para herramientas de todo tipo.

**Características del equipamiento:**

- Tirantes acolchados con bolsillo para móvil
- Bolsillos de redicilla delanteros y a un lateral
- Bolsillo lateral para guardar tarjetas de visita
- Tirantes elásticos de sujeción
- Bolsa de herramientas separada y extraíble
- Compartimentos múltiples para almacenaje
- Compartimentos interiores para anotaciones pads/laptop/tablet PC
- Diseño robusto y resistente con varios extras
- Muy comfortable para llevar, con diseño ergonómico



Bestell-No./Order-No.	Art. No.	Maße · Dimensions			€
50810520000	5081052	460 x 350 x 180 mm	2500	1	200,50

**5081052-9**

92-tlg./pcs./dlg./pcs./pzs.



**Montage-Werkzeugsortiment im Rucksack**

Hochwertiger Rucksack mit separater Innentasche für Werkzeuge aller Art.

Tool assortment in backpack  
High quality backpack with separate inner pocket for all kinds of tools.

Montage gereedschapset in rugzak

Hoogwaardige rugzak met apart binnenvak voor diverse gereedschappen.

Assortiment d'outils en sac à dos

Sac à dos de haute qualité avec poche intérieure séparée pour toute sorte d'outils.

Juego de herramientas en mochila

Mochila de alta calidad con bolsillo interior separado para herramientas de todo tipo.



enthaltend/containing

- 5 m
- 250 mm
- 180 mm
- 180 mm
- 150 - 250 V
- 300 g
- 150 mm
- 10 Stk./pcs.
- Gr. 18 mm
- 170 - 500 mm
- 230 mm
- 205 mm
- 250 mm
- MM 8/9/10/11/13/14/17/19
- MM 1,5/2/2,5/3/4/5/6/8/10
- Geprüft nach DIN EN 166 F
- MM 4,0 x 75 / 5,5 x 125 / 6,5 x 150
- PH 1 / 2
- 150 mm
- R1 - R2
- 3,5 - 8
- 2 - 8
- PH 1 - 3
- PZ 1 - 3
- TT 9 - 40
- 125 mm
- MM 8/10/11/13/15/17/18/19/22/24
- MM 20,8

Bestell-No./Order-No.	Art. No.	Maße · Dimensions			€
<b>50810529200</b>	5081052-9	460 x 350 x 180 mm	10600	1	<b>559,95</b>

## 5081052-5

50-tlg./pcs./-dlg./pces./pzs.

### Dachdecker-Sortiment im Rucksack

Hochwertiger Rucksack mit separater  
Innentasche für Werkzeuge aller Art.

Slater assortment in backpack

High quality backpack with separate  
inner pocket for all kinds of tools.

Dakdekkers gereedschapset  
in rugzak

Hoogwaardige rugzak met apart  
binnenvak voor diverse gereedschappen.

Assortiment pour couvreur  
en sac à dos

Sac à dos de haute qualité avec poche  
intérieure séparée pour toute sorte  
d'outils.

Juego de herramientas para  
trabajos en tejados

Mochila de alta calidad con bolsillo  
interior separado para herramientas de  
todo tipo.



enthaltend/containing



5 m



195 - 570 mm



230 mm



200 mm



260 mm

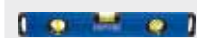

400 mm



200 mm



200 mm



200 mm / 8"

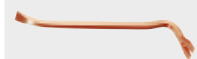

400 mm



Geprüft nach  
DIN EN 166 F



CE/EN 388-4131



Gr. 18 mm



600 g



300 mm / 11,8"



17+22er  
Zahnung  
teeth per inch



315 mm  
19 x 22



Bestell-No./Order-No.

**50810525000**

Art. No.

5081052-5

Maße · Dimensions

460 x 350 x 180 mm



8100



1

€

**496,45**

Einfaches Verschrauben von Bewehrungsstäben und Muffenverbindungen für Stahlbetonanwendungen. Die Einhand-Spannzange ist bestens geeignet für runde, ovale und eckige Geometrien. Für alle namhaften Hersteller von Bewehrungstechniken (z.B. Lenton, Halfen etc.). Die gehärtete Stellmutter und die Spannzange verhindern mit der Federzentrierung ein ungewolltes Verstellen und sorgen für höchste Sicherheit bei der Selbstklemmung.

- Drehmomenteinstellung von 40-210 Nm, Spannbereich 5-40 mm
- Drehmomenteinstellung von 70-350 Nm, Spannbereich 10-60 mm

Easy screwing of reinforcing rods and socket joints for reinforced concrete applications. The one-hand clamp is best suited for round, oval and square shapes. For application with products of all renowned manufacturers of reinforcement gear (e.g. Lenton, Halfen etc.). The hardened adjusting nut and the clamp in combination with the spring centering prevent an unintended mechanical shift of the wrench ensuring utmost safety of the self-clamping.

- Torque adjustment range 40-210 Nm, clamping range 5-40 mm
- Torque adjustment range 70-350 Nm, clamping range 10-60 mm



**50888021080**  
**50888035080**

**Drehmomentschlüssel,  
verstellbar  
mit Einhand-Spannzange**

Aufgrund der Stillson Einhand Zange ist der Drehmomentschlüssel bestens geeignet für runde, ovale und eckige Geometrien, die außerhalb von gängigen DIN Normen liegen. Die gehärtete Stellmutter verhindert mit der Federung ein ungewolltes Verstellen und sorgt für höchste Selbstklemmung. Besonders geeignet im Bauhandwerk für Eisenflechter und Stahlbetonbauer sowie im Maschinen- und Anlagenbau.

**Adjustable torque wrench  
with one-hand clamp**

Due to the Stillson one-handed pliers, the torque spanner is ideally suited for round, oval and angular geometries that lie outside common DIN standards. The hardened adjusting nut with the spring prevents unintentional adjustment and ensures maximum self-clamping. Particularly suitable in the building trade for ironworkers and reinforced concrete builders as well as in mechanical and plant engineering.

**Verstelbare momentsleutel  
met eenhand pijptang**

Dankzij de Stillson eenhandige tang is de momentsleutel bij uitstek geschikt voor ronde, ovale en hoekige geometrieën die buiten de gangbare DIN-normen vallen. De geharde stelmoer met veer voorkomt onbedoelde verstelling en zorgt voor maximale zelfklemming. Bijzonder geschikt in de bouwsector voor ijzerwerkers en bouwers van gewapend beton, alsook in de machinebouw en de installatietechniek.

**Clé dynamométrique, réglable  
avec clé à tuyau**

Grâce à la pince Stillson à une main, la clé dynamométrique est parfaitement adaptée aux géométries rondes, ovales et angulaires qui se situent en dehors des normes DIN courantes. L'écrou de réglage trempé avec le ressort empêche tout réglage involontaire et assure un auto-serrage maximal. Convient particulièrement bien dans le bâtiment pour les monteurs de charpentes métalliques et les constructeurs de béton armé, ainsi que dans la construction de machines et d'installations.

**Llave dinamométrica, ajustable  
con pinza de una mano**

Gracias a los alicates de una mano Stillson, la llave dinamométrica es ideal para geometrías redondas, ovaladas y angulares que quedan fuera de las normas DIN comunes. La tuerca de ajuste endurecida con el muelle evita el ajuste involuntario y garantiza la máxima autofijación. Especialmente adecuado en el sector de la construcción para los ferrallistas y los constructores de hormigón armado, así como en la ingeniería mecánica y de instalaciones.

**NEW**

**HEYCO  
GARANTIE  
GUARANTEE**

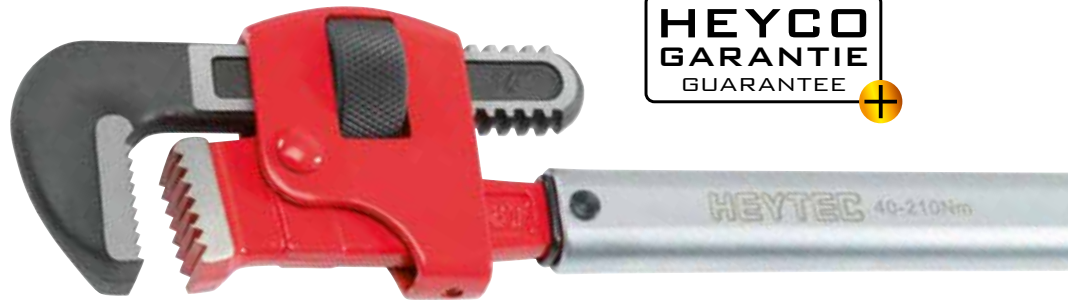

Bestell-No./Order-No.	Cl mm	Nm	: mm	g		€
<b>50888021080</b>	600	40-210	5-40	2200	1	<b>312,25</b>
<b>50888035080</b>	730	70-350	10-60	3700	1	<b>365,20</b>



Lieferung in gepolsterter Umhängetasche mit Trageriemen zum sicheren Transport zum Einsatzort, schützt vor Schmutz und Nässe.  
Supplied in a cushioned bag with carrying strip for safe transport to the building site, optimum dirt and moisture protection.

50879  
50880  
50882  
50885  
50886

1/4" 3/8" 1/2" 3/4"

Drehmomentschlüssel  
mit Hebelumschaltknarre  
Chrom-Vanadium in Kunststoffbox.

Torque wrenches  
with reversible ratchet  
Chrome-Vanadium in plastic box.

Momentsleutel  
met omschakelpal  
Chroom-Vanadium in kunststof koffer.

Clé dynamométrique  
avec cliquet réversible  
Chrome-Vanadium en coffret plastique.

Llaves dinamométrica  
con carraca reversible  
Cromo Vanadio en estuche de  
polipropileno.

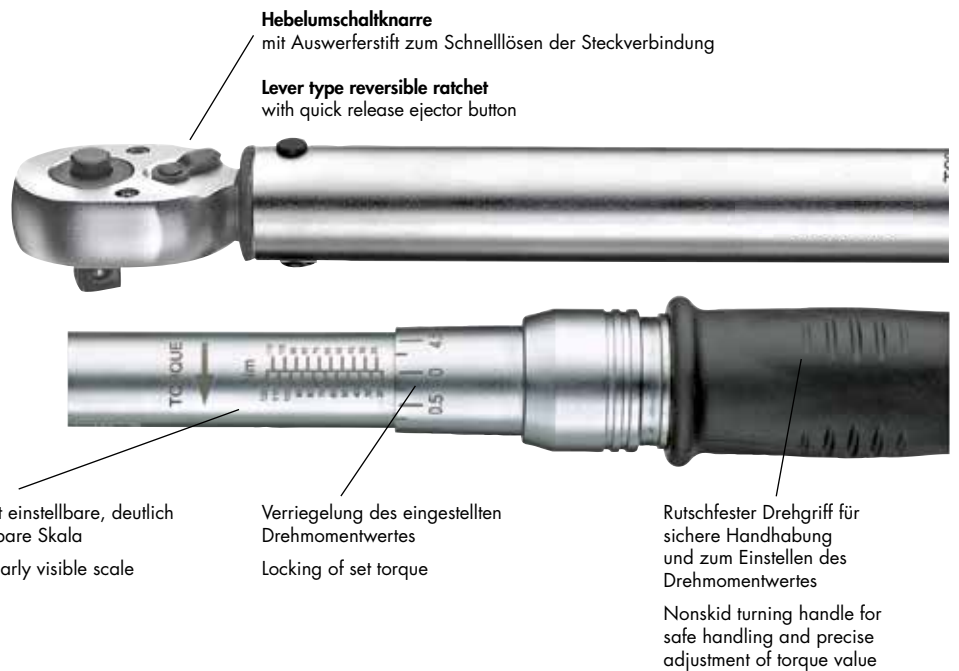

**Hebelumschaltknarre**  
mit Auswerferstift zum Schnelllösen der Steckverbindung

**Lever type reversible ratchet**  
with quick release ejector button

Gut einstellbare, deutlich  
lesbare Skala  
Clearly visible scale

Verriegelung des eingestellten  
Drehmomentwertes  
Locking of set torque

Rutschfester Drehgriff für  
sichere Handhabung  
und zum Einstellen des  
Drehmomentwertes

Nonskid turning handle for  
safe handling and precise  
adjustment of torque value

Bestell-No./Order-No.	Art. No.	■	Nm	CLD mm	⚖️	📦	€
<b>50879000080</b>	50879	1/4"	3-15	190-210	290	1	<b>128,95</b>
<b>50880000080</b>	50880	1/4"	4-20	300-320	865	1	<b>141,20</b>
<b>50882000080</b>	50882	3/8"	20-120	405-435	1665	1	<b>173,60</b>
<b>50885000080</b>	50885	1/2"	40-200	485-510	2020	1	<b>178,90</b>
<b>50886000080</b>	50886	3/4"	100-600	1035-1052	5047	1	<b>712,55</b>

**508201-614**

140 Nm

1/2"

Drehmomentschlüssel

Torque wrench

Draaimomentsleutel

Clé dynamométrique

Llave dinamométrica fija



Bestell-No./Order-No.	Art. No.	Nm	CLD mm	g	g	€
* <b>50820161483</b>	508201-614	140	410	1021	1	<b>49,15</b>

\* Auslauf / Discontinued

**50895-1**

72 Zähne/teeth/tanden/dents/dientes

Einstecknarre

Chrom-Vanadium, verchromt,  
umschaltbar.

Reversible ratchet heads

Chrome-Vanadium, chromium plated,  
with reversible ratchet.

Insteekratel

Chroom-Vanadium, verchromd,  
omschakelbaar.

Cliquet à emmanchement

Chrome-Vanadium, chromé,  
avec cliquet réversible.

Cabezal de carraca

Cromo Vanadio, cromada con  
carraca reversible.



Bestell-No./Order-No.	Art. No.	■	L3 mm	D mm	H mm	für • for	g	g	€
<b>50895100080</b>	50895-1	1/2"	25,00	37,00	43,00	50895	250	1	<b>41,30</b>

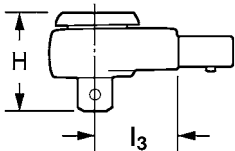

**50895-31**

Einsteckmaulschlüssel

Open ended jaw wrench  
insert tools

Insteeksteeksleutel

Clé à fourche à  
emmanchement

Llave de boca abierta



Chrom-Vanadium  
Chrome-Vanadium

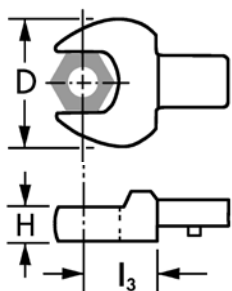

Bestell-No./Order-No.	Art. No.	MM	L3 mm	D mm	H mm	für • for	g	g	€
* <b>50895311380</b>	50895-31	13	25,0	30,0	7,0	50895	125	1	<b>18,95</b>
* <b>50895311480</b>	50895-31	14	25,0	32,0	7,0	50895	130	1	<b>18,95</b>
* <b>50895311780</b>	50895-31	17	25,0	37,0	9,0	50895	130	1	<b>18,95</b>
* <b>50895311880</b>	50895-31	18	25,0	39,0	9,0	50895	145	1	<b>18,95</b>
* <b>50895311980</b>	50895-31	19	25,0	41,0	9,0	50895	145	1	<b>18,95</b>
* <b>50895312280</b>	50895-31	22	25,0	47,0	11,0	50895	165	1	<b>21,45</b>
* <b>50895312480</b>	50895-31	24	25,0	51,0	11,0	50895	170	1	<b>25,25</b>
* <b>50895312780</b>	50895-31	27	32,5	58,5	13,0	50895	215	1	<b>27,75</b>
* <b>50895313080</b>	50895-31	30	32,5	63,0	13,0	50895	245	1	<b>27,75</b>

\* Auslauf / Discontinued







**5082016**

8-tlg./pcs./-dlg./pces./pzs.

**Radwechsel-Werkzeugsatz**

Für den schnellen und einfachen Radwechsel am PKW, zur Aufbewahrung in der Ersatzradmulde im Kofferraum.

**Wheel changing tool set**

For quick application to remove a tyre, insert for storage in the trunk.

**Wielwissel gereedschapset**

Gereedschapset voor het snel en eenvoudig wisselen van wielen bij personenauto's.





**Kit démontage de roues**

Kit pour changement rapide et facile de roues de voitures..

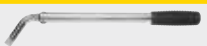

**Juego de herramientas para cambio de rueda**

Facilita un cambio rápido de neumáticos, para guardar en el maletero.

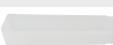

enthaltend/containing	
	CL ⇨ 410 mm Drehmomentschlüssel / Torque wrench, 140 Nm
	CL ⇨ 75 mm MM 15/17/19/21/22
	CL ⇨ 160 mm 
	CL ⇨ 200 mm Radmutternbox / Wheel nut box



Bestell-No./Order-No.	Art. No.	Maße · Dimensions			€
* <b>50820160900</b>	5082016	L 550 x B 470 x H 40 mm	2500	1	<b>104,80</b>

\* Auslauf / Discontinued

**5082016**

- Drehmomentschlüssel, Festwert 140 Nm, 1/2" - Antrieb
- Extra lange Steckschlüsseleinsätze, Chrom-Vanadium Stahl
- Aufbewahrungsbox leer, für Felgenschloss/Radschrauben
- Umsteckschraubendreher
- Lichtstreifen 18 LED mit Schalter, spritzwassergeschützt
- 4 Batterien 1,5 V AA inklusive
- Sicherheitsreflektor, beidseitig
- Integriertes Kniebrett
- Batteriefach rückseitig, spritzwassergeschützt
- Hochwertiger 2-K Schaumstoff
- Fixed torque wrench, 140 Nm, 1/2" drive
- Extra deep chrome Vanadium sockets
- Empty storage box for rim lock/wheel bolt
- Reversible screwdriver
- Light pad with 18 LED, splash-proof
- 4 batteries 1.5 V AA included
- Reflective strips on front/back side
- Integrated kneeboard
- Battery compartment on the back, splash-proof
- High grade 2 components foam



## 5086300 - 5086300-19

### Impact-Steckschlüssel

Chrom-Molybdän-Stahl, mit Kunststoffhülse und Kunststoffeinsteck zum Schutz von Alufelgen. Mit Kugelfangrinne und Bohrung, für Hand- und Schlagschraubetrieb.

### Impact sockets

Chrome-molybdenum steel for protection of alloy wheels, with ball retaining groove and bore hole for manual operation or impact and power driven tools.

### Kracht dop

Chroom-Molybdeenstaal, met kunststof huls en kunststof inleg ter bescherming van aluminium velgen met kogelvanggroef en boring, hand- en slagschroevendraaiergebruik.

### Douilles impact

Chrome-Molybdène, avec gaine plastique de protection des jantes en aluminium, avec élément de retenue de la bille, pour utilisation à main et à choc.

### Llaves de vaso de impacto

Acero al cromo molibdeno, con protectores de plástico para no dañar llantas de aluminio, con ranura y agujero para su fijación, para apriete manual y a máquina.



5086300



5086300-19



Bestell-No./Order-No.	Art. No.	MM	mm	g		€
<b>50863001760</b>	5086300	17	85	216	1	<b>9,45</b>
<b>50863001960</b>	5086300	19	85	227	1	<b>9,45</b>
<b>50863002160</b>	5086300	21	85	255	1	<b>9,45</b>

Bestell-No./Order-No.	Art. No.	MM	mm	g		€
<b>50863191760</b>	5086300-19	17	150	375	1	<b>20,15</b>
<b>50863191960</b>	5086300-19	19	150	400	1	<b>20,15</b>
<b>50863192160</b>	5086300-19	21	150	440	1	<b>20,15</b>

## Impact-Steckschlüsselsatz

Impact sockets set

Kracht dopsleutelset

Composition de douilles impact

Llaves de vaso de impacto

### 5086300-3

3-tlg./pcs./-dlg./pces./pzs.

Mit Kunststoffhülse in Box.

In box, with plastic sleeves and plastic inserts.

Met kunststof hulzen in box.

Avec gaine plastique en boîte.

Con protectores de plástico, en estuche.



Bestell-No./Order-No.	Art. No.	MM	mm	g		€
<b>50863000300</b>	5086300-3	17/19/21	85	820	1	<b>30,25</b>

### 5086300-19-3

6-tlg./pcs./-dlg./pces./pzs.

Mit Kunststoffhülse in Box, extra lang für Tiefbetfelgen, SW 17, 19, 21 mm + 3 Ersatz Kunststoffschonhülsen.

In box, including, 3 spare sleeves, extra long for full drop center rims, 17, 19, 21 mm.

Met kunststof hulzen in box, extra lang voor brede velgen SW 17, 19, 21 mm + drie reserve kunststof hulzen.

Avec gaine plastique en boîte, extra-longues pour jantes à base creuse 17, 19, 21 mm et 3 gaines plastiques de rechange.

Con protectores de plástico, en estuche, extra largas para llantas con asientos de tornillo profundos, bocas exagonales de 17, 19 y 21 mm, con 3 protectores de plástico de recambio.



Bestell-No./Order-No.	Art. No.	MM	mm	g		€
<b>50863190300</b>	5086300-19-3	17/19/21	150	1460	1	<b>69,40</b>

## 50253

### Wasserpumpenzange

Mit durchgestecktem Gleitgelenk, Chrom-Vanadium, lackiert, teilweise geschliffen, Griffe kunststoffbeschichtet.

### Water pump pliers

With box joints, Chrome-Vanadium, lacquered, partly ground, plastic coated handles.

### Waterpomptang

Met doorgestoken scharnier Chrom-Vanadium, gelakt, gedeeltelijk geslepen, grepen met kunststof overtrokken.

### Pince multiprise

Charnière entrepassée et glissière, Chrome-Vanadium, laquée partiellement meulée, poignées gainées plastique.

### Tenaza para bombas de agua

Unión machihembrada, Cromo Vanadio, pintada, parcialmente pulida, mangos plastificados.



Bestell-No./Order-No.	Art. No.	Clamp mm	Weight g	Length mm	€
<b>5025320834</b>	50253	250	385	1	<b>13,85</b>

## 5081330/5081331

### Eckrohrzangen

Kopf induktiv gehärtet und poliert, pulverbeschichtet, Rolle unverlierbar.

### Elbow pipe wrenches

Face inductive hardened and polished, powder coated, roll captive.

### Hoekpijptang

Chroom-Vanadium, kop inductief gehard en gepolijst, poedergecoat.

### Clé à tube

Tête trempée par induction et polie, revêtement par pulvérisation, roulette imperdable.

### Llaves para apretar los tubos en ángulos

Cabezal inductivo templado y pulido, con recubrimiento pulvimetalúrgico, rollo imperdible.



5081330



5081331

Bestell-No./Order-No.	Art. No.	Clamp mm	Clamp "	Weight g	Length mm	€
<b>50813301020</b>	5081330	320	1	800	1	<b>24,00</b>
<b>50813301520</b>	5081330	425	1.1/2	1450	1	<b>35,30</b>
<b>50813311020</b>	5081331	320	1	760	1	<b>24,00</b>
<b>50813311520</b>	5081331	425	1.1/2	1450	1	<b>35,30</b>

- Griffe mit 2-K Kunststoffhandschutz
- 2K plastic handle
- greep uit 2 componenten kunststof
- Poignées revêtues bimatière
- mangos con funda de plástico 2K

### 5081209

DIN ISO 5745

#### Flachrundzange, gerade

Kopf geschliffen und lackiert,  
Schneide für mittelharten Draht.

Snipe nose plier, straight  
Head ground and lacquered,  
cutting edges for middlehard wire.

#### Telefoontang, recht

Kop gepolijst en gelakt,  
knipt middelharde draad.

#### Pince à becs demi-ronds, droits

Tête chromée et laquée,  
pour fil de dureté moyenne.

#### Alicate de radio, recto

Cabeza amolada y barnizada,  
cortante para alambre semi-duro.

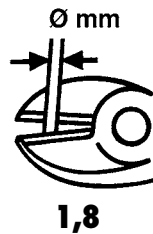

Bestell-No./Order-No.	Art. No.	CLD mm	g	1	€
50812082042	5081208	200	185	1	15,75

### 5081209

DIN ISO 5745

#### Flachrundzange, 45° abgewinkelt

Kopf geschliffen und lackiert,  
Schneide für mittelharten Draht.

Snipe nose plier, 45° angle  
Head ground and lacquered,  
cutting edges for middlehard wire.

#### Telefoontang, 45° gebogen

Kop gepolijst en gelakt,  
knipt middelharde draad.

#### Pince à becs demi-ronds, coudés à 45°

Tête chromée et laquée,  
pour fil de dureté moyenne.

#### Alicate de radio, curvo a 45°

Cabeza amolada y barnizada,  
cortante para alambre semi-duro.

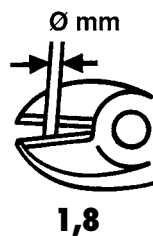

Bestell-No./Order-No.	Art. No.	CLD mm	g	1	€
50812092042	5081209	200	185	1	16,85

### 5081200

DIN ISO 5746

#### Kombinationszange

Kopf geschliffen und lackiert,  
Schneide für mittelharten Draht.

Combination plier  
Head ground and lacquered,  
cutting edges for middlehard wire.

#### Combinatietang

Kop gepolijst en gelakt,  
knipt middelharde draad.

#### Pince universelle

Tête chromée et laquée,  
pour fil de dureté moyenne.

#### Alicate universal

Cabeza amolada y barnizada,  
cortante para alambre semi-duro.

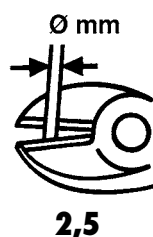

Bestell-No./Order-No.	Art. No.	CLD mm	g	1	€
50812001842	5081200	180	260	1	15,75

- Griffe mit 2-K Kunststoffhandschutz
- 2K plastic handle
- greep uit 2 componenten kunststof
- Poignées revêtues bimatière
- mangos con funda de plástico 2K

**5081212**  
DIN ISO 5749

**Kraftseitenschneider**  
Spezialstahl, Kopf geschliffen und lackiert,  
Schneide für harten Draht (Piano Draht).

Diagonal cutting nipper  
Head ground and lacquered,  
cutting edges for piano wire.

Kracht zijsnijtang  
Speciaalstaal, kop gepolijst en gelakt,  
knipt harde draad (pianodraad).

Pince coupante diagonales  
Acier spécial, tête chromée et laquée,  
pour fil dur (corde à piano).

Alicate cortalambr  
Acero especial, Cabeza amolada y  
barnizada, cortante para alambre  
cuerda de piano.

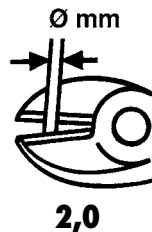

Bestell-No./Order-No.	Art. No.	CLD mm	g	1	€
<b>50812121842</b>	5081212	180	255	1	<b>16,85</b>

**5081213**  
DIN ISO 5749

**Seitenschneider,  
schwedische Form**  
Kopf geschliffen und lackiert,  
Schneide für mittelharten Draht.

Diagonal cutting nipper,  
swedish pattern  
Head ground and lacquered,  
cutting edges for middlehard wire.

Zijsnijtang, zweeds model  
Kop gepolijst en gelakt,  
knipt middelharde draad.

Pincés coupante diagonales  
modèle suédois  
Tête chromée et laquée,  
pour fil de dureté moyenne.

Alicate cortalambr  
modelo sueco  
Cabeza amolada y barnizada,  
cortante para alambre semi-duro.

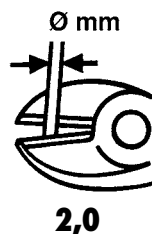

Bestell-No./Order-No.	Art. No.	CLD mm	g	1	€
<b>50812131642</b>	5081213	160	220	1	<b>15,75</b>

**5081241**  
DIN ISO 9242A

**Kneif-/Rabitzzange**  
Mattschwarz lackiert mit polierten  
Backen, tauchisoliert, Schneide für  
mittelharten Draht.

Tower pincers  
Satin black lacquered finish with  
polished jaws, plastic coated handles.

Moniertang  
Matzwart gelakt met gepolijste bekken,  
dompelisolatie.

Tenaille  
Laquée noir mat avec becs polis,  
poignées isolées.

Tenaza rusa  
Pintada en negro mate,  
bocas pulidas, mangos plastificados.

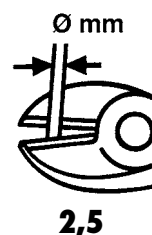

Bestell-No./Order-No.	Art. No.	CLD mm	g	1	€
<b>50812412213</b>	5081241	230	330	1	<b>11,55</b>
<b>50812412513</b>	5081241	250	410	1	<b>13,65</b>

## 5081242

DIN 5241

### Kantenzange

Mattschwarz lackiert  
mit polierten Backen, tauchisoliert.

### End cutting plier

Satin black lacquered finish with  
polished jaws, plastic coated handles.

### Nijptang

Matzwart gelakt  
met gepolijste bekken, dompelsolatie.

### Tenaille de menuisier

Laquée noir mat  
avec becs polis, poignées isolées.

### Tenaza de corte frontal

Pintada en negro mate,  
bocas pulidas, mangos plastificados.



Bestell-No./Order-No.	Art. No.	ClO mm	g	mm	€
50812422013	5081242	200	430	10	12,60

## 50812501750

4-tlg./pcs./-dlg./pces./pzs.

### Montagezangen-Satz

Chrom-Vanadium, vernickelt. Griffe kunststoffbeschichtet, gerade und abgewinkelt, für Innen- und Außensicherungen, Zangenspitze Ø 2,0 mm.

### Circlip plier set

Chrome-Vanadium steel, nickel plated, non-slip cushion grip handles, straight and bent tips, for internal and external circlips, pliers tip Ø 2,0 mm.

### Borgringtangenset

Chroom-Vanadium, vernikkeld. Greep met dompelsolatie. Recht en haaks, voor binnen- en buitenborgringen. Punt Ø 2,0 mm.

### Jeu de pinces circlip

Chrome-Vanadium nickelé. Poignées revêtues. Droites et courbées, pour les circlip internes et externes. Pointes Ø 2,0 mm.

### Juego de alicates de montaje

Cromo vanadio, niquelado. Mangos recubiertos de plástico, rectas y en ángulo para anillos de seguridad internos y externos. Punta del alicate Ø 2,0 mm.

**NEW**



In stabiler Kunststoffmappe.  
Solid vinyl wallet.

Bestell-No./Order-No.	ClO mm	Maße · Dimensions	g	mm	€
50812501750	175	200 x 150 x 40 mm	760	1	23,90

## 5081670

### Profi Universal-Schere

Edelstahl Klingen mit feinsten Sägezahnprofilierung für hohe Standzeiten und beste Schneideergebnisse, einhändige Verriegelung.

### Professional universal scissors

Stainless steel blades with finest saw tooth tread design for high durability and best cutting results, single-handed locking.

### Professionele universeelschaar

RVS bek met zeer fijne vertanding voor hoge standtijd en beter snijresultaat, eenhands vergrendeling.

### Ciseaux universels professionnels

Lame en acier inoxydable avec dents de scie très fin pour une longue vie et meilleurs résultats de coupe, blocage d'une seule main.

### Tijera universal profesional

Hojas de acero inoxidable con perfil dentado para alta resistencia y perfectos cortes, bloqueo a una sola mano.

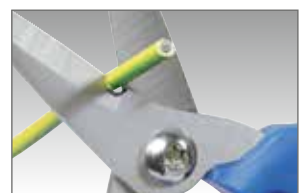

Ergonomischer 2-K Griff.  
Ergonomic 2-K handle.

Bestell-No./Order-No.	Art. No.	ClO mm	g	mm	€
50816700800	5081670	200	180	1	24,25





#### 5081670

- Abisolierung von Drähten mit den Durchmessern  
1 mm<sup>2</sup>, 1,5 mm<sup>2</sup>, 2 mm<sup>2</sup>
- Ideal geeignet zum Schneiden von Drähten, Kunststoffen,  
Leder und Teppichen
- Einkerbung in der Klinge erleichtert das Schneiden  
von runden Materialien
- Automatische Öffnung durch innenliegende Feder
  
- Stripping of wires with  
1.0 mm<sup>2</sup>, 1.5 mm<sup>2</sup>, 2.0 mm<sup>2</sup> wire cross section
- Ideal for cutting wires, plastics, leather and carpets
- A notch in the blade simplifies cutting of round materials
- Automatic opening by internal spring

## 5081259

### Multifunktionszange

2-K-Griff aus hochwertigem Luffahrt-Aluminium mit Kunststoffeinlage, Flachrundzange, Standardzange, Drahtschneider, Säge, Dosenöffner, kleiner Schraubendreher, Kreuzschlitz-Schraubendreher, Messer, Feile mit Schraubendreher, Fischentschupper, Hakenlöser, Flaschenöffner.

### Multifunction plier

With 2-K handle, made of high grade aircraft aluminium with plastic inlay. Long nose plier. Standard plier. Wire cutter. Saw. Can opener. Mini-screwdriver. Philips Screwdriver. Knife, File with screwdriver. Fish scaler with ruler. Hook remover. Bottle opener.

### Mini Multitool

Met 2 componentengreep uit hoogwaardig luchtvaartaluminium met kunststof inleg. Telefoon tang. Draadknipper. Zaag. Blikopener. Schroevendraaier voor zaagsnede. Kruikschroevendraaier. Mes. Vijl. Gekarteld mes. Flesopener.

### Pince multifonction

Avec poignée en 2K, fabriqué en aluminium de haute qualité aéronautique et avec insert en plastique. Pince à bec demi rond. Pince universelle à béc demi-ronds. Coupe fil. Scie. Ouvre-boîte. Petit-tournevis. Tournevis Philips. Couteau. Lime avec tournevis. Ecaillage à poisson. Dégorgeoir. Ouvre bouteille.

### Alicate multiusos

De aluminio aeronáutico de gran calidad, con injerto de plástico y fundas de plástico 2-K. Alicata de radio. Alicata universal. Cortalambres. Sierra. Abrelatas. Mini-destornillador. Destornillador Phillips. Navaja. Lima con destornillador. Limpiaescamas. Extractor de anzuelo. Abridor de botella.

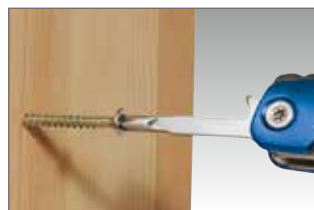

Bestell-No./Order-No.	Art. No.	CLD mm	g	mm	€
<b>50812590000</b>	5081259	160	180	1	<b>16,85</b>
* <b>50812591200</b>	5081259-12	160	2160	1	<b>168,30</b>

\*Lieferung im Verkaufdisplay • Delivery in sale display

## 5081259-1

### Multifunktionszange mit Gürteltasche

Multifunction plier with belt pouch

Mini multitool met riemtas

Pince multi usage avec sac de ceinture

Alicata multiuso con cinturón portaherramientas

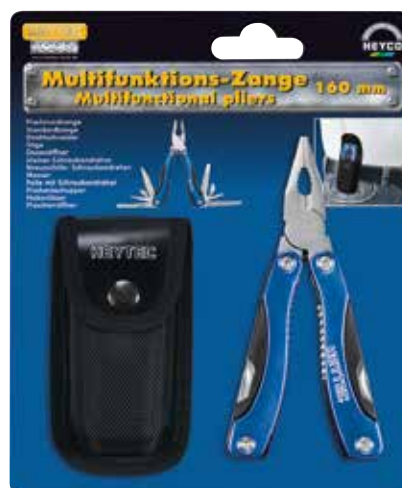

Bestell-No./Order-No.	Art. No.	CLD mm	g	mm	€
<b>50812590100</b>	5081259-1	160	195	1	<b>23,20</b>

Lieferung in Blisterverpackung / Supplied in blister packing

## 5081280

### Gripzange

Lösehebel mit Kunststoffhülle.

Grip pliers

Plastic coated release lever.

Griptang

Ontspanhendel met kunststof overtrokken.

Pince-étai

Levier de déclenchement gainé plastique.

Tanazas grip

Palanca de desbloqueo con funda de plástico.

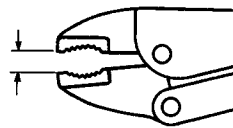

**max. 45 mm**



Bestell-No./Order-No.	Art. No.	GLD mm			€
<b>50812802550</b>	5081280	235	440	1	<b>17,70</b>

## 5081621-1

### Hebelblechschere, gerade und rechtsschneidend

Geschmiedete Schneiden aus Chrom-Vanadium, gezahnt, Kunststoffhüllen mit Gleitschutz.

Lever plate shear,  
straight, right hand cutting

Forged Chrome-Vanadium cutting edges,  
gogged, plastic handle with slip guard.

Blikschaar, recht, rechts

Gesmede bekken van Chrom-Vanadium,  
getand, kunststof grepen met anti-slip.

Cisailles à tôle démultipliées  
chantourneuse à droite

Tranchant forgé en Chrome-Vanadium,  
denté, gaines plastique avec protection  
antiféropante.

Tijeras cortachapas corte recto  
y a derecha

Cortantes forjados de acero al Cromo  
Vanadio, dentadas, fundas de plástico  
con tope protejamosos.



Bestell-No./Order-No.	Art. No.	GLD mm			€
<b>50816210132</b>	5081621-1	260	490	1	<b>24,60</b>

## 5081647-35

### Schlauchschneidezange

Zum einfachen Schneiden und Durchtrennen von Schläuchen aus PVC und Gummi. Griff mit PVC-Isolierung für optimale Handhabung.

Hose cutting pliers

For cutting and separating of PVC- and  
rubber-tubes. Handle with PVC insulation  
for optimum handling.

Slangknipper

Voor het eenvoudig en recht snijden van  
slangen van PVC en rubber. Greep met  
PVC-isolatie voor stevig grip.

Pince coupe tuyau

Pour couper et diviser facilement des  
tubes en PVC et caoutchouc. Poignée  
avec isolation PVC pour une manipulation  
optimale.

Tenaza cortamangueras

Para cortar toda clase de mangueras de  
PVC y goma. Mangos recubiertos de PVC  
para un óptimo manejo.

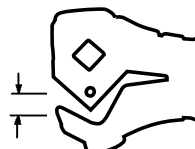

**Ø 6-35 mm**



Doppelte Standzeit/Lebensdauer, aufgrund von  
Doppelklingenfunktion, Halterung lösen und  
Klinge um 90° drehen.

Double life cycle, because of double blade  
function, remove the bracket and rotate the  
blade by 90 degrees.

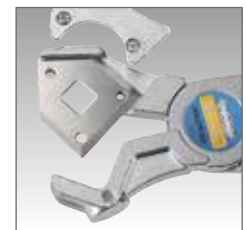

Bestell-No./Order-No.	Art. No.	GLD mm			€
<b>50816473500</b>	5081647-35	255	440	1	<b>51,85</b>
* <b>50816470000</b>	5081647		20	1	<b>16,80</b>

\*Ersatzmesser • Spare blade

## 5081720

### Stablampe mit LED-Licht

Stufenlos ausziehbar, mit magnetischem Leuchtkopf, inkl. Batterien.

#### LED Torchlight

Progressively extensible, with lighting magnetic head, incl. batteries.

#### Zaklantaarn met LED licht

Traploos uitschuifbaar, met magnetische kop, incl. batterijen.

#### Lampe torche „LED“

Extensible, avec tête magnétique éclairante. Piles incluses.

#### Linterna LED

Extensible sin escalones, con cabezal luminoso magnético, incluyendo baterías.



Bestell-No./Order-No.	Art. No.	CLD mm	U	g		€
<b>5081720000</b>	5081720	170 - 500	600 g	100	1	<b>15,75</b>

## 50817210300

### Arbeitslampe

Zur optimalen Ausleuchtung von dunklen Arbeitsbereichen. Gehäuse aus ABS-Kunststoff mit gummierter Oberfläche für sicheren Halt in der Hand, inkl. Batterien.

#### Working lamp

For perfect illumination of dark areas, weight 200 g. ABS-plastic housing with rubberised surface, incl. batteries.

#### Werklamp

Voor het optimaal belichten van donkere werkplekken. Behuizing van ABS met rubberen oppervlak voor stevige grip, incl. batterijen.

#### Lampe d'atelier

Pour un éclairage optimal des coins sombres. Boîtier en ABS avec revêtement soft grip pour une meilleure haptique. Piles incluses.

#### Lámpara de trabajo

Para una iluminación óptima de las zonas de trabajo oscuras. Carcasa de plástico ABS con superficie de goma para un agarre seguro en la mano, incluye pilas.



**NEW** +

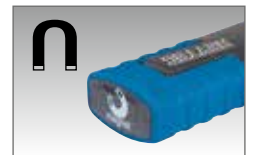

Bestell-No./Order-No.	Maße · Dimensions	g		€
<b>50817210300</b>	220 x 55 x 32 mm	200	1	<b>13,65</b>

## 5081730

### Stirnleuchte mit LED-Licht

3 Helligkeitsstufen schaltbar, zusätzlich Blinklicht bei Volllicht, verstellbare elastische Haltebänder, inkl. Batterien.

#### LED Headlamp

3 lighting degree, as well winking at full intensity, adjustable elastic support, incl. batteries.

#### Hoofdlamp met LED licht

3 lichtsterktes instelbaar, knipperfunctie bij volledige sterkte, verstellbare, elastische helmband, inkl. Batterien.

#### Lampe frontale „LED“

3 intensités d'éclairage, en plus, lumière clignotante en position maximale, support élastique réglable. Piles incluses.

#### Linterna para casco LED

3 intensités d'éclairage, fonction clignotant en position maximale, sangles élastiques réglables, piles incluses.



Lieferung ohne Helm  
Delivery without safety helmet  
Levering zonder helm  
Livrée sans casque de chantier  
Suministro sin casco

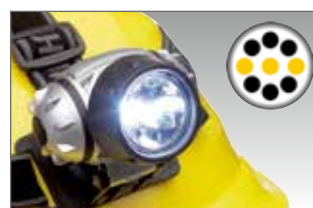
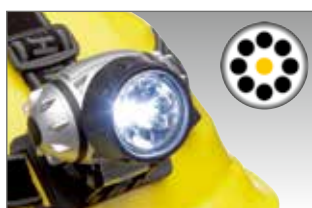

Bestell-No./Order-No.	Art. No.	g		€
<b>5081730000</b>	5081730	120	1	<b>8,35</b>

**50817210300**

- Zur optimalen Ausleuchtung von dunklen Arbeitsbereichen
  - Gehäuse aus ABS-Kunststoff mit gummierter Oberfläche für sicheren Halt in der Hand
  - 180° schwenkbares Griffstück, selbstarretierend
  - Starker Magnet am Fußteil
  - Umschaltbar von Haupt- auf Frontlicht
  - COB LED Hauptlicht (400 lm)
  - SMD LED Frontlicht (120 lm)
  - inkl. Batterien (3 x AA 1,5 V)
- 
- for perfect illumination of dark areas, weight 200 g
  - ABS-plastic housing with rubberised surface
  - adjustable handle
  - with strong magnet
  - top and main light
  - COB LED main light (400 lm)
  - SMD LED top light (120 lm)
  - incl. batteries (3 x AA 1,5 V)



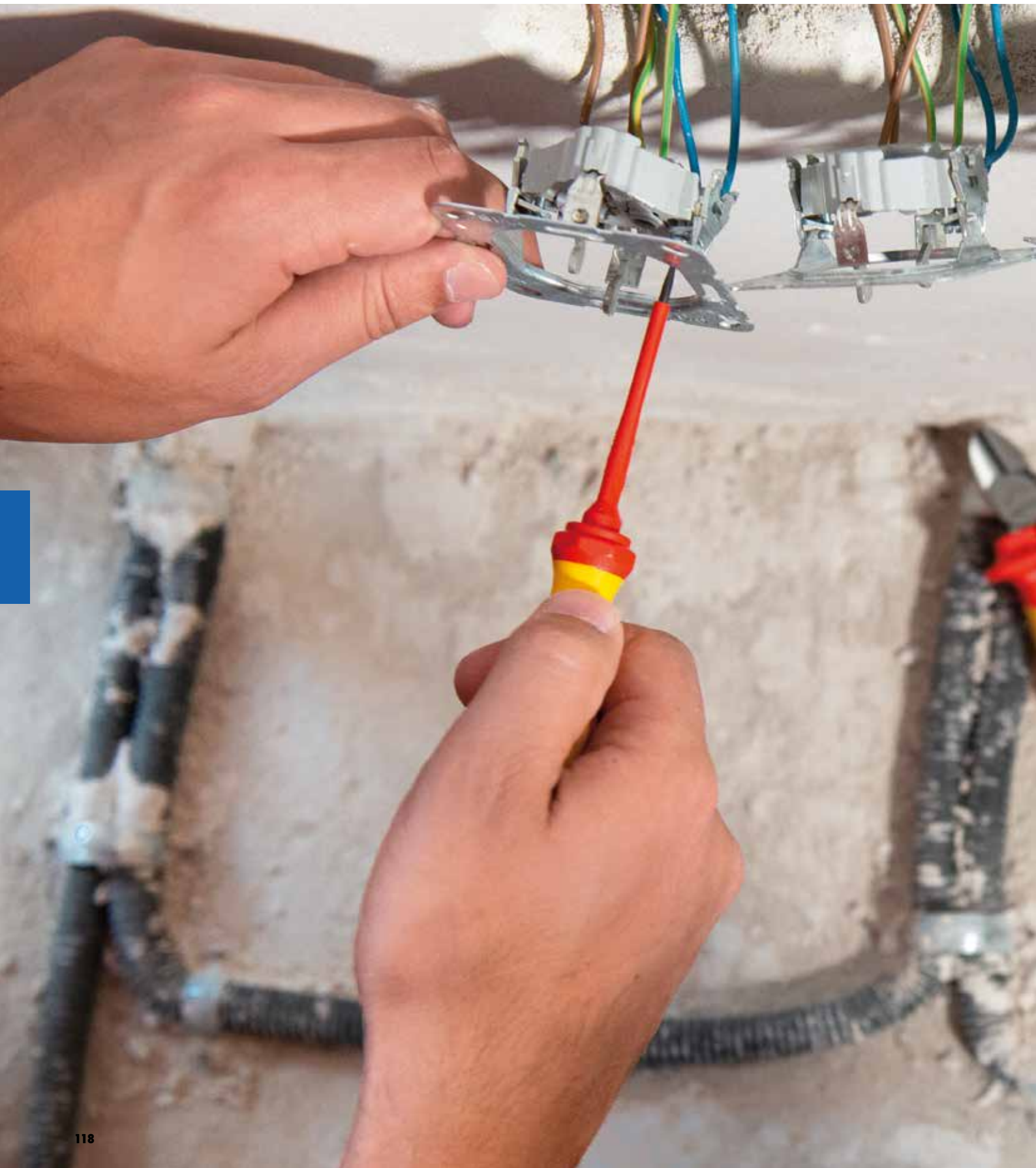



**5081052-27**

IEC 60900  
 DIN 7437 / DIN 7438 PZ  
 26-tlg./pcs./-dlg./pces./pzs.



**Elektriker Rucksack mit VDE-Werkzeugsortiment**

Hochwertiger Rucksack mit separater Innentasche für Werkzeuge aller Art.

Electricians backpack with VDE tool set

High quality backpack with separate inner pocket for all kinds of tools.

Electriciēns rugzak met VDE gereedschapset

Hoogwaardige rugzak met apart binnenvak voor diverse gereedschappen.

Sac à dos pour électricien avec ensemble d'outils VDE

Sac à dos de haute qualité avec poche intérieure séparée pour toute sorte d'outils.

Mochila para electricista, con juego de herramientas VDE

Mochila de alta calidad con bolsillo interior separado para herramientas de todo tipo.

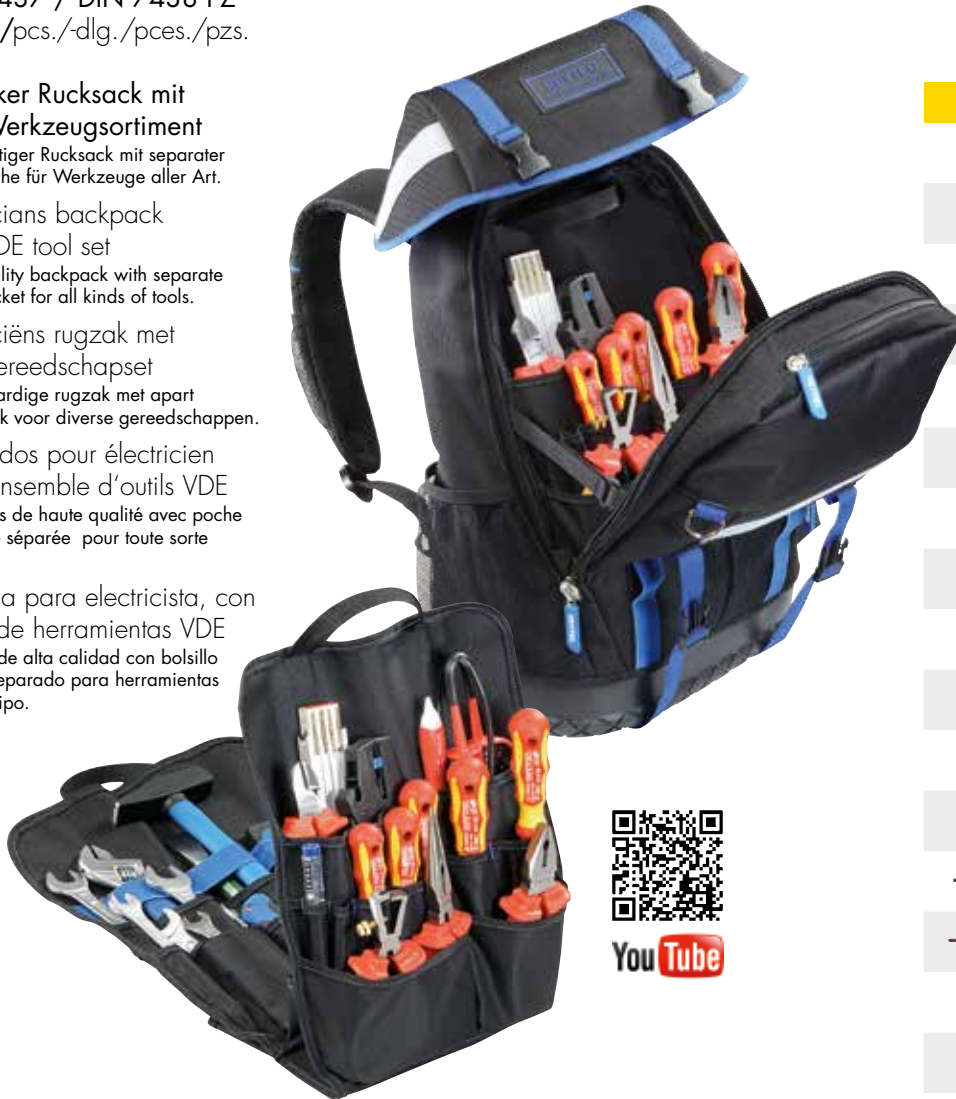

enthaltend/containing

	180 mm
	160 mm
	200 mm
	160 mm
	200 mm
	150 - 250 V
	115 - 195 mm
	110 mm
	200 mm
	205 mm
	MM 8/9/10/11/13/14/17/19
	230 mm
	MM 4,0 x 100 / 5,5 x 125 / 2,5 x 75
	PZ 1 / 2
	300 g
	24 x 250 mm



<b>5081052</b>	
Rucksack	
Backpack	
Rugzak	
Sac	
Mochila	
	<b>83-90</b>

Bestell-No./Order-No.	Art. No.	Maße · Dimensions			€
<b>50810522700</b>	5081052-27	460 x 350 x 180 mm	6600	1	<b>465,30</b>

**5081052-28**

IEC 60900  
 DIN 7437 / DIN 7438 PZ  
 28-tlg./pcs./-dlg./pces./pzs.



**Elektriker Rucksack mit VDE-Werkzeugsortiment**

Electricians backpack with VDE tool set

Electriciēns rugzak met VDE gereedschapset

Sac à dos pour électricien avec ensemble d'outils VDE

Mochila para electricista, con juego de herramientas VDE



enthaltend/containing  
 wie/as 508105227, jedoch/but

	12 - 690 V
	12 - 1000 V



Bestell-No./Order-No.	Art. No.	Maße · Dimensions			€
<b>50810522800</b>	5081052-28	460 x 350 x 180 mm	6900	1	<b>540,95</b>



## 50848-1

### Umhängetasche für Werkzeuge, leer

Hochwertige Aufbewahrungstasche mit Klemmhaltesystem sowie Einsteckfächern für Werkzeuge aller Art.

#### Ausstattungsmerkmale:

- Gepolsterter Trageriemen
- Robuster Tragegriff
- Ausklappbarer Stellfuß für sicheren Stand
- Kleinteilmagazin
- Geschütztes, gepolstertes Laptop-Fach
- Zusätzliches Fach für Dokumente

### Shoulder bag for tools, empty

Premium-quality storage bag with locking system and compartments for all kinds of tools.

#### Features:

- Cushioned carrying strap
- Robust carrying handle
- Fold-out foot for a secure stand
- Small parts magazine
- Protected, cushioned laptop-compartment
- Additional compartment for documents

### Leren gereedschapstas

Hoogwaardige gereedschapstas met gereedschapsklemmen en insteekvakken voor allerhande gereedschappen.

#### Uitgerust met:

- Gepolsterde draagriem
- Robuuste draaggreep
- Uitklapbare stelvoet
- Vakkendoos voor kleine materialen
- Beschermd, gepolsterd laptopvak
- Extra vak voor documenten

### Sacoché à outils, vide

Alvéoles de rangement de haute qualité avec système de serrage, ainsi que des poches pour tous types d'outils.

#### Caractéristiques:

- Bandoulière rembourrée
- Poignée de transport robuste
- béquille pour plus de stabilité
- Compartiment pour petites pièces
- Compartiment rembourré pour ordinateur portable
- Compartiments à documents



### Cartera para herramientas, vacío

Cartera de calidad, con pinzas y bolsillos para guardar herramientas de todo tipo.

#### Características del equipamiento:

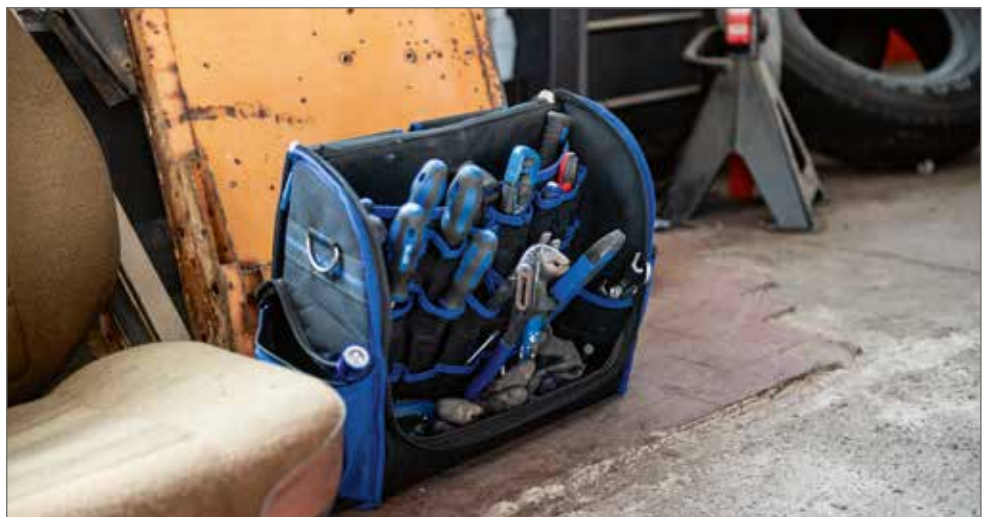
- Correa acolchada
- Asa robusta
- Pie plegable para una colocación segura
- Recipiente para piecero pequeño
- Compartimento acolchado para lap-top
- Compartimento adicional para documentos



Bestell-No./Order-No.	Art. No.	Maße · Dimensions			€
50848010000	50848-1	555 x 410 x 180 mm	2400	1	168,30

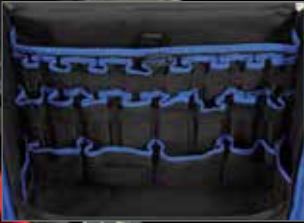

**50848-26**  
IEC 60900  
DIN 7437 / DIN 7438 PZ  
26-tlg./pcs./-dlg./pces./pzs.



**Elektrikertasche mit  
VDE-Werkzeugsortiment**

Electricians bag  
with VDE tool set

VDE Elektriçiens-gereedschap-  
set in tas

Sacoche à outils d'électricien,  
équipée VDE

Bolsa de electricistas con  
conjunto de herramientas



enthaltend/containing	
	180 mm
	160 mm
	200 mm
	160 mm
	200 mm
	150 - 250 V
	115 - 195 mm
	110 mm
	200 mm
	205 mm
	MM 8/9/10/11/ 13/14/17/19
	230 mm
	MM 4,0 x 100 / 5,5 x 125 / 2,5 x 75
	PZ 1 / 2
	300 g
	24 x 250 mm



Bestell-No./Order-No.	Art. No.	Maße · Dimensions			€
<b>50848002600</b>	50848-26	555 x 410 x 180 mm	6105	1	<b>422,45</b>

**50848-27**  
IEC 60900  
DIN 7437 / DIN 7438 PZ  
28-tlg./pcs./-dlg./pces./pzs.

**Elektrikertasche mit  
VDE-Werkzeugsortiment**

Electricians bag  
with VDE tool set

VDE Elektriçiens-gereedschap-  
set in tas

Sacoche à outils d'électricien,  
équipée VDE

Bolsa de electricistas con  
conjunto de herramientas



enthaltend/containing wie/as 50848002600, jedoch/but	
	12 - 690 V
	12 - 1000 V

Bestell-No./Order-No.	Art. No.	Maße · Dimensions			€
<b>50848002700</b>	50848-27	555 x 410 x 180 mm	6380	1	<b>507,00</b>

### 50846-33

IEC 60900:2004  
270 1000V11   
18-tlg./pcs./-dlg./pces./pzs.



#### VDE-Elektrikersatz

In Rolltasche mit Gürtelschlaufe.

#### VDE Electricians-set

In wallet with belt loop.

#### VDE Električiens-set

In roltas met riemlus.

#### Outils pour électricien VDE

En trousse avec coulant pour ceinture.

#### Set eléctrico VDE

En bolsa enrollable con riñonera.



#### enthaltend/containing

MM 0,4 x 2,5 x 100  
MM 0,6 x 3,5 x 100  
MM 0,8 x 4,0 x 100  
MM 1,0 x 5,5 x 100

TX 10 x 100  
TX 15 x 100  
TX 20 x 100

PZ 1 x 100  
PZ 2 x 100

PH 1 x 100  
PH 2 x 100

150 - 250 V

5 mm / 7 - 8 mm

9 mm

3 - 5 mm

115 mm



Bestell-No./Order-No.	Art. No.	Maße · Dimensions			€
<b>50846000033</b>	50846-33	220 x 130 x 70 mm	575	1	<b>73,05</b>

### 50847-33

IEC 60900:2004  
270 1000V11   
8-tlg./pcs./-dlg./pces./pzs.



#### VDE-Elektrikersatz

In Rolltasche mit Gürtelschlaufe.

#### VDE Electricians-set

In wallet with belt loop.

#### VDE Električiens-set

In roltas met riemlus.

#### Outils pour électricien VDE

En trousse avec coulant pour ceinture.

#### Set eléctrico VDE

En bolsa enrollable con riñonera.



#### enthaltend/containing

MM 0,4 x 2,5 x 100  
MM 0,6 x 3,5 x 100  
MM 0,8 x 4,0 x 100  
MM 1,0 x 5,5 x 100

PH 1 x 100  
PH 2 x 100

115 mm



Bestell-No./Order-No.	Art. No.	Maße · Dimensions			€
<b>50847000033</b>	50847-33	220 x 100 x 50 mm	350	1	<b>47,65</b>

**50849-14**  
IEC 60900  
DIN 7437 / DIN 7438 PZ  
13-tlg./pcs./dlg./pces./pzs.



**VDE-Elektrikersatz**

In Gürteltasche.  
VDE Electricians-set  
In belt pouch.  
VDE Električiens-set  
In ríemtas.

Outils pour électricien VDE  
En porte-outils de ceinture.

Set eléctrico VDE  
En cinturón porta-herramientas.



enthaltend/containing	
	180 mm
	160 mm
	200 mm
	200 mm
	115 - 195 mm
	195 - 570 mm
	12 - 690 V
	150 - 250 V
	MM 0,4 x 2,5 x 75/ 0,8 x 4,0 x 100/ 1,0 x 5,5 x 125
	PZ 1 / 2

Bestell-No./Order-No.	Art. No.	Maße · Dimensions			€
<b>50849001400</b>	50849-14	380 x 300 x 100 mm	2225	1	<b>263,55</b>

**Modul \*\*\***  
**M 50829-18**  
IEC 60900  
DIN 7437 / DIN 7438 PZ  
12-tlg./pcs./dlg./pces./pzs.



**VDE-Werkzeugsortiment\***

In 2-K Schaumstoffeinlage.  
VDE Tool set\*  
With 2 components foam insert.  
VDE Gereedschapset\*  
In 2 componenten schuiminleg.

Sélection d'outillage VDE\*  
En plateau mousse bicolore.

Conjunto de herramientas VDE\*  
Con material de espuma 2 componentes alta gama.



enthaltend/containing	
	180 mm
	160 mm
	200 mm
	160 mm
	200 mm
	115 - 195 mm
	195 - 570 mm
	12 - 690 V
	150 - 250 V
	MM 0,4 x 2,5 x 75/ 0,8 x 4,0 x 100/ 1,0 x 5,5 x 125
	PZ 1 / 2

Bestell-No./Order-No.	Art. No.	Maße · Dimensions			€
<b>50829001800</b>	M 50829-18	435 x 340 x 35 mm	2910	1	<b>239,80</b>

\* Passend für HEYTEC-Werkstattwagen 5081129 · For HEYTEC workshop trolley 5081129

- Griffe mit 2-K Isoliergriffen
- Kopf geschliffen und lackiert
- Schneide für mittelharten Draht
- 2K insulated handle
- head ground and lacquered
- cutting edges for middlehard wire

- 2 componenten isolatiegreep
- kop gepolijst en gelakt
- grepen knipt middelharde draad
- Poignées gainées et isolées bimatières
- chromées et laquées branches
- pour fil de dureté moyenne
- mangos con fundas aislantes 2K
- cabeza amolada y barnizada
- cortante para alambre semi-duro



### 5081200

IEC 900/DIN EN 60900  
DIN ISO 5746

VDE Kombinationszange  
VDE Combination plier  
VDE Combinatietang  
VDE Pince universelle  
VDE Alicata universal

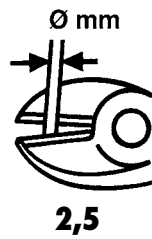

Bestell-No./Order-No.	Art. No.	Ø mm	g	mm	€
<b>50812001888</b>	5081200-VDE	180	260	1	<b>25,95</b>

### 5081208

IEC 900/DIN EN 60900  
DIN ISO 5745

VDE Flachrundzange, gerade  
VDE Snipe nose plier, straight  
VDE Telefoontang, recht  
VDE Pince à becs demi-ronds, droits  
VDE Alicata de radio, recto

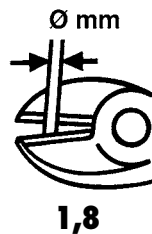

Bestell-No./Order-No.	Art. No.	Ø mm	g	mm	€
<b>50812082088</b>	5081208-VDE	200	185	1	<b>25,95</b>

### 5081209

IEC 900/DIN EN 60900  
DIN ISO 5745

VDE Flachrundzange,  
45° abgewinkelt  
VDE Snipe nose plier,  
45° angle  
VDE Telefoontang,  
45° gebogen  
VDE Pince à becs demi-ronds,  
coudés à 45°  
VDE Alicata de radio,  
curvo a 45°

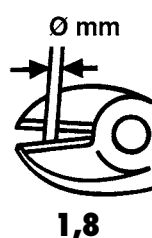

Bestell-No./Order-No.	Art. No.	Ø mm	g	mm	€
<b>50812092088</b>	5081209-VDE	200	185	1	<b>28,60</b>

- Griffe mit 2-K Isoliergriffen
- Kopf geschliffen und lackiert
- 2K insulated handle
- head ground and lacquered
- 2 componenten isolatiegreep
- kop gepolijst en gelakt
- Poignées gainées et isolées bimatière
- Tête chromée et laquée
- mangos con fundas aislantes 2K
- cabeza amolada y barnizada



### 5081212

IEC 900/DIN EN 60900  
DIN ISO 5749

#### VDE Kraftseitenschneider

Spezialstahl, Schneide für harten Draht (Piano Draht).

#### VDE Diagonal cutting nipper

Special steel, cutting edges for piano wire.

#### VDE Kracht zijsnijtang

Speciaalstaal, knipt harde draad (piano draad).

#### Pince coupante VDE

Acier spécial, pour fil dur (corde à piano).

#### VDE Alicata cortalambre

Acero especial, cortante para alambre cuerda de piano.

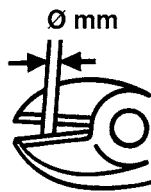

2,0



Bestell-No./Order-No.	Art. No.	CLD mm			€
<b>50812121888</b>	5081212-VDE	180	255	1	<b>28,60</b>

### 5081213

IEC 900/DIN EN 60900  
DIN ISO 5749

#### VDE Seitenschneider, schwedische Form

Schneide für mittelharten Draht.

#### VDE Diagonal cutting nipper, swedish pattern

Cutting edges for middlehard wire.

#### VDE Zijsnijtang, zweeds model

Knipt middelharde draad.

#### Pince coupante VDE, modèle suédois

Pour fil de dureté moyenne.

#### VDE Alicata cortalambre, modelo sueco

Cortante para alambre semi-duro.

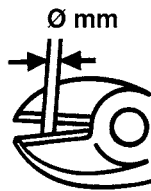

2,0



Bestell-No./Order-No.	Art. No.	CLD mm			€
<b>50812131688</b>	5081213-VDE	160	220	1	<b>25,95</b>

### 5081220

IEC 900/DIN EN 60900

#### VDE Abisolierzange

Mit Stellschraube und Öffnungsfeder.

#### VDE Wire stripping pliers

With adjusting screw and spring.

#### VDE Kabelstriptang

Met stelschroef en veer.

#### Pince à dénuder VDE

Avec vis de réglage de butée et ressort d'ouverture.

#### VDE Alicates pelacables

Con tornillo de ajuste y muelle de operatura.



Bestell-No./Order-No.	Art. No.	CLD mm			€
<b>50812201688</b>	5081220-VDE	160	203	1	<b>28,60</b>

### 50849-9

IEC 60900

9-tlg./pcs./dlg./pces./pzs.

#### VDE-Werkzeugsatz

Mit hochwertiger Schaumstoffeinlage in hochwertigem Kunststoffkoffer.

#### VDE Tool set

With foam insert in high grade plastic case.

#### VDE Gereedschapset

Met schuiminleg in hoogwaardige kunststof koffer.

#### Sélection d'outillage VDE

Avec intérieur mousse en coffret plastique.

#### Conjunto de herramientas VDE

Con material de espuma alta gama en caja de plástico.

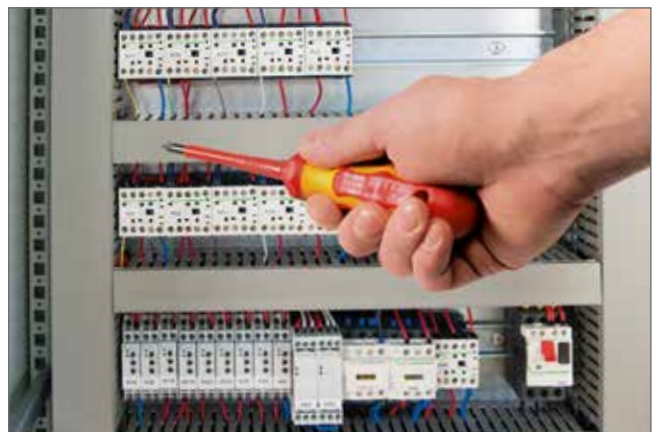
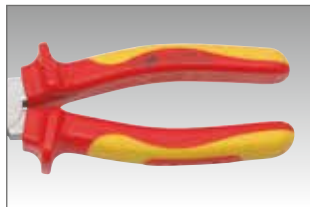

#### enthaltend/containing



160 mm



150 - 250 V



200 mm

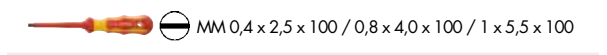

MM 0,4 x 2,5 x 100 / 0,8 x 4,0 x 100 / 1 x 5,5 x 100

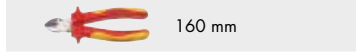

160 mm

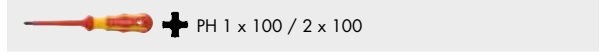

PH 1 x 100 / 2 x 100

Bestell-No./Order-No.

**50849000900**

Art. No.

50849-9

Maße · Dimensions

340 x 275 x 83 mm



1550



1

€

**157,70**



## 5081265

### Crimpzange

Profi Crimpzange mit Hebelübersetzung. Geschraubtes Gelenk, hohe Stabilität und gleichmäßiger Lauf. Hochfester Spezialstahl. Ergonomischer 2-K Griff für ermüdungsfreies Arbeiten. Zum Kabelschneiden, Abisolieren von Kabeln und Crimpen von isolierten und unisolierten Kabelschuhen und Steckverbindern. Top-Qualität, Multifunktion 5 in 1, Kapazität: 0,75 - 5,5 mm.



### Crimping tool

Professional crimping tool with lever transmission. Bolted hinge, high stability and smooth operation. High-tensile special steel. Ergonomic 2-K handle for fatigue-proof working. For cutting of cables, stripping of wires and crimping of insulated/ non-insulated cable lugs and connectors. Premium quality, multifunction 5 in 1, Capacity: 0.75 - 5.5 mm.

### VDE Kracht zijnsnijtang

Professionele krimp tang met hefboom overbrenging. Geschoefd scharnier, hoge stabiliteit en gelijkmatige bediening. Hoogsterkte staal. Ergonomische 2-k greep voor comfortabel werken. Kabelschaar, verwijderen van kabelisolatie, Krimpen van geïsoleerde kabelschoentjes, Krimpen van ongeïsoleerde kabelschoentjes. Top kwaliteit, multifunctioneel 5 in 1, capaciteit: 0,75 - 5,5 mm.

### Pince à sertir

Pince à sertir professionnelle avec effet de levier. Charnière boulonnée, grande stabilité et bon fonctionnement. Acier de haute résistance. Manche ergonomique à 2 composants pour travail antifatigue. Cutter de cables, dénudage des cables, sertissage des cosses de câble isolées, sertissage des cosses de câble non-isolées. Qualité top, multifonction 5 en 1, capacité: 0,75 - 5,5 mm.

### Tenaza para terminales

Tenaza para terminales, calidad profesional con multiplicación de fuerza. Unión con tornillo, buena estabilidad y suave accionamiento. De acero especial. Mango ergonómico con fundas de 2 componentes para un trabajo sin esfuerzo. Cortacables, para pelar cables, para comprimir terminales con aislamiento, para comprimir terminales sin aislamiento. Calidad Premium, Multifunción 5 en 1, capacidad 0.75 - 5.5 mm.

Farbkodierte Querschnittzuordnung. Gewindelöcher zum Abschneiden von Gewindestiften. Colour coded coordination of cross section. Threaded holes for cutting of grub screws.

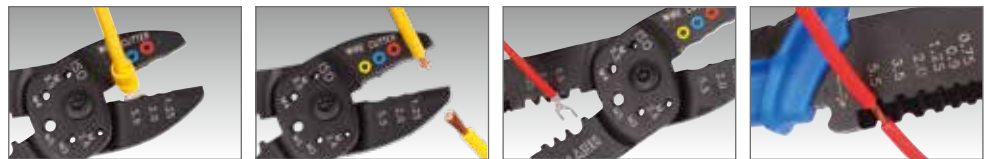

Bestell-No./Order-No.	Art. No.	CLD mm	g	Stk.	€
<b>50812650000</b>	5081265	200	270	1	<b>26,35</b>



enthaltend/containing

Isolierte Flachsteckhülsen  
Insulated Receptacles  
10 St./pcs. AWG 22-16 / 16-14

Isolierte Flachstecker  
Insulated Tabs (Spade Terminals)  
10 St./pcs. AWG 22-16 / 16-14

Stoßverbinder  
Butt Connectors  
40 St./pcs. AWG 22-16 / 16-14 / 12-10

Unisolierte Ringkabelschuhe  
Non-Insulated Ring Terminals  
40 St./pcs. AWG 22-16 / 16-14 / 12-10; M3 - M4 - M5

Unisolierte Gabelkabelschuhe  
Non-Insulated Fork Terminals  
40 St./pcs. AWG 22-16 / 12-10; M3 - M4 - M5

Isolierte Ringkabelschuhe  
Insulated Ring Terminals  
25 St./pcs. AWG 22-16 / 16-14 / 12-10; M3 - M4 - M5

Isolierte Gabelkabelschuhe  
Insulated Fork Terminals  
25 St./pcs. AWG 22-16 / 16-14 / 12-10; M3 - M4 - M5

Kabelklemmen/Cable Clamps  
10 St./pcs. 1/4" - 1/8"

Gummi-Kabeldurchführungen  
Grommets  
15 St./pcs. 3/16" - 1/4" - 3/8"

Blindstecker  
Blind Plugs  
5 St./pcs. AWG 22-16

NiederspannungsAutosicherungen  
Low Voltage Car Fuses  
20 St./pcs. 5/10/15/25 A

Kabelschnellverbinder  
Quick Splice Connectors  
8 St./pcs. AWG 22-16 / 16-14

## 5081267

249-tlg./pcs./-dlg./pces./pzs.

### Crimpzangen-Set

Crimping tool-set

Krimptangen set

Assortiment pinces à sertir

Set de tenazas para terminales

Bestell-No./Order-No.	Art. No.	Maße - Dimensions	g	Stk.	€
<b>50812670000</b>	5081267	305 x 215 x 50 mm	930	1	<b>78,15</b>

## 5081426

12 - 690 Volt

### Spannungsprüfer

LEDs für europäische Spannungsanzeige, L/R LEDs für Phasenrotationstest, Strom-LED, Polaritäts-anzeige-LEDs für Spannung, LCD Display, Durchgangsprüfung, Hochspannungsanzeige. Inklusive Batterien.

### Voltage tester

LED's for European voltage indication, L/R LEDs for phase rotation test, Current-LED, polarity indication-LEDs for voltage, LCD Display, Continuity Test, High Voltage Indication. Including batteries.

### Spanningtester

LED's voor Europese spanningsaanduiding, L/R LED's voor fase rotatietest, stroom LED, polariteitsaanduiding - LED's voor spanning, LCD display, doorgangstest, hoogspanningsaanduiding. Incl. batterijen.

### Détecteur de tension

LED'S pour l'affichage de tension européenne, L/R pour test de rotation de phase, Power LED, affichage de polarité, LED de puissance, écran LCD, Continuité, Indicateur de haute tension. Piles incluses.

### Buscapolos

LEDs para indicador de tensión europeo, LED D/I para test de rotación de fase, Luz de LED, LED de indicador de polaridad para tensión, pantalla de LCD, test de continuidad, indicador de alta tensión. Se incluyen baterías.



GS: CAT III 690 V  
ETL: CAT IV 600 V



Zweipolig, mit LED-Licht  
Bipolar, with LED light

Geprüft nach IEC 61010-1, Schutzart IP 64, automatische Abschaltung.  
Complying with IEC 61010-1, protection type IP 64.

12/24/50/120/230/400/690 V



20,65	Art. No.	Volt · Volt			€
<b>50814260000</b>	5081426	12 - 690	275	1	<b>79,30</b>

## 5081428

12 - 1000 Volt

### Berührungsloser Spannungstester

Kompaktes 2-K Kunststoffgehäuse, mit optischem und zusätzlich akustischem Signal, Einstellrad für Ein- und Ausschalten sowie zur stufenlosen Anpassung an die zu prüfende Spannung und den örtlichen Gegebenheiten.

### Contactless voltage tester

Compact 2-k plastic housing, with optical and acoustical signal, with thumb wheel for switching on and off and for continuous adaption to the test voltage and local conditions.

### Contactloze spanningsmeter

Compact 2-K kunststof behuizing, met optisch en akoestisch signaal, duimwiel voor in- en uitschakelen en voor traploze aanpassing aan de te meten spanning en plaatselijke condities.

### Testeur de tension sans contact

Boîtier compact en matière plastique à 2 composants, avec signal optique et acoustique, roulette d'allumage, éteignage et réglage commandable avec le pouce.

### Comprobador sin contacto directo

Cuerpo compacto de plástico de 2 componentes, con señal óptica y acústica, ruedecilla para adaptación al voltaje a comprobar y las condiciones específicas.



Berührungsloses Erkennen von spannungsführenden Leitern, z.B. Kabel, Steckdosen, Verteiler, Anschlussdosen etc. Lieferung erfolgt mit Batterien.

Contactless detection of live power lines, e.g. cables, power outlets, dividers, sockets etc. Supplied with batteries.



Bestell-No./Order-No.	Art. No.	Volt · Volt			€
<b>50814280000</b>	5081428	12 - 1000	50	1	<b>19,50</b>

Bei allen Arbeiten an spannungsführenden Teilen steht die Sicherheit an oberster Stelle. Dazu gehört auch der Einsatz von speziell hierfür hergestellten isolierten Werkzeugen. Diese müssen den internationalen Normen entsprechen und alle Prüfungen hinsichtlich mechanischer und elektrischer Sicherheit bestehen. Wir können mit Überzeugung sagen, dass wir Ihnen die besten Werkzeuge, die alle sicherheitsrelevanten Kriterien erfüllen, an die Hand geben.

Electric safety is always the top priority when working on live electrical systems. This also requires the use of insulated tools specially manufactured for the job. These must fulfil international standards and pass all tests with regard to mechanical and electrical safety. We can say with absolute certainty that we provide only the best tools that fulfil all safety-relevant criteria.



- 2K-VDE-Schraubendreher, ergonomischer Softgriff
- With ergonomic 2 components soft grip plastic handle
- 2 componenten VDE schroevendraaier, ergonomische soft grip
- Tournevis VDE à poignée 2 composants
- Destornillador VDE según mango ergonómico de dos componentes

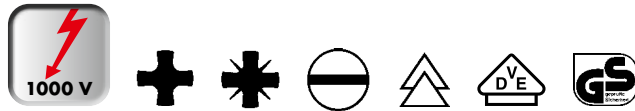

### 5084511 - 5084536

IEC 60900 : 2004  
VDE 006282 Teil/part 201  
DIN 7437/DIN 7438 PZ

#### VDE Schraubendreher

Klingen aus Chrom-Vanadium-Stahl, gehärtet, geschwärzt und mit umspritzter Klingenisolierung.

#### VDE-Screwdriver

Blades from chrome vanadium steel, hardened, with black tip, insulation of blade and handle injection moulded as one unit.

#### VDE Schroevendraaier

Klingen uit chroom-vanadiumstaal, gehard, gezwart en met omspoten klingisolatie.

#### Tournevis VDE

Lame en chrome-vanadium durci, bruni, lame gainée, isolée.

#### Destornilladores VDE

Varilla de acero al cromo vanadio, templada, pavonada y con aislamiento inyectado.

Bestell-No./Order-No.	Art. No.	+	*	—	g	g	€
<b>50845110133</b>	5084511 VDE	PH 1			90	10	<b>7,80</b>
<b>50845110233</b>	5084511 VDE	PH 2			92	10	<b>8,85</b>
<b>50845110333</b>	5084511 VDE	PH 3			94	10	<b>12,15</b>
<b>50845120133</b>	5084512 VDE		PZ 1		60	10	<b>8,25</b>
<b>50845120233</b>	5084512 VDE		PZ 2		90	10	<b>9,90</b>
<b>50845120333</b>	5084512 VDE		PZ 3		92	10	<b>13,65</b>
<b>50845367533</b>	5084536 VDE			0,4 x 2,5 x 75 mm	54	10	<b>6,60</b>
<b>50845361033</b>	5084536 VDE			0,8 x 4,0 x 100 mm	80	10	<b>7,30</b>
<b>50845361233</b>	5084536 VDE			1,0 x 5,5 x 125 mm	82	5	<b>8,35</b>

### 5084550 - VDE

IEC 60900 : 2004  
VDE 006282 Teil/part 201  
DIN 7437/DIN 7438 PZ  
6-tlg./pcs./-dlg./pcs./pzs.



#### VDE Schraubendreher-Satz

#### VDE-Screwdriver set

#### VDE Schroevendraaier-set

#### Tournevis VDE

#### Destornilladores VDE

Bestell-No./Order-No.	Art. No.	—	*	g	g	€
<b>50845500033</b>	5084550 VDE		PZ 1	490	1	<b>51,85</b>
			PZ 2			
		0,5 x 2,5 x 75 mm				
		0,8 x 4,0 x 100 mm				
		1,0 x 5,5 x 125 mm				
		Spannungsprüfer/Voltage tester				
		0,75 x 3,0 x 60 mm				

### 5081424

150 - 250 Volt

#### Spannungsprüfer, vollisoliert

Vernickelte Klinge, transparenter Griff.

Voltage tester, fully insulated  
Blade nickel plated, transparent handle.

Spanningzoeker,  
volledig geïsoleerd

Vernikkelde kling, transparante greep.

Détecteur de tension,  
isolation totale

Poignée transparente nickelée.

Buscapolos, aislamiento integro  
Varilla niquelada, mango transparente.



Bestell-No./Order-No.	Art. No.	—	g	g	€
<b>50814240050</b>	5081424	0,75 x 3,0 x 60 mm	20	10	<b>3,70</b>

## 50839 - VDE

DIN 3117

### VDE Einmaulschlüssel, verstellbar

Chrom-Vanadium, verchromt mit schutzisoliertem Griff nach DIN EN 60900 und Skala.

VDE Adjustable wrench  
Chrome-Vanadium, chromium plated, insulated handle complying with EN 60900 and scale.

VDE verstelbare moersleutel  
Chroom-Vanadium, verchromd, met geïsoleerde greep volgens DIN EN 60900 en schaal aanduiding.

Clé à molette VDE  
Chrome-Vanadium, chromé, avec poignée isolée conforme norme EN 60900.

VDE llaves ajustables  
Cromo Vanadio, cromado, con mango para aislamiento según EN 60900 y Skala.



Bestell-No./Order-No.	Art. No.	mm	CLD "	MM/AF	g	mm	€
* 50839001088	50839 - VDE	255	10	0 - 30 0 - 1.1/4"	540	5	30,45

\* Auslauf / Discontinued

## 5081221

### Automatische Abisolierzange

Zum Abisolieren von Elektrodrähten, Litzenleitern und Kabeln.

Automatic wire stripping plier  
For stripping of electric wires, stranded wires and cables.

Automatische kabelstriptang  
Voor strippen van elctradraad en kabels.

Pince à dénuder automatique  
Pour le dénudage de fils électriques, fils torsadés et câbles.

Pinzas pelacables automáticos  
Para pelar aâmbres elétricos, conductores trenzados y cables.

Abisolierbereich PVC-isolierte Leiter 0,2 - 6 mm<sup>2</sup> Querschnitt, einstellbare Abisolierlänge bis 18 mm, Drahtschneider bis 4 mm<sup>2</sup>.  
For PVC-insulated cables 0,2 - 6 mm<sup>2</sup> cross-section, adjustable stripping plier up to 18 mm, perfect insulation trough automatic adjustment to insulation thickness, with wire cutter up to 4 mm<sup>2</sup>.



Bestell-No./Order-No.	Art. No.	CLD mm	g	mm	€
50812211900	5081221	200	390	1	29,10

## 5081668

### Kabel-Klappmesser

Mit 2-K Griff, für schnelle Kabel- und Drahtabisolierung, rostfreie Klinge.

Cable folding knife  
With 2-K handle, for quick stripping of cables and wires, blade of stainless steel.

Inklapbaar kabelmes  
Met 2 componenten greep, voor snel kabel- en draadstrippen, rvs lemmeet.

Couteau d'électricien  
Bimatière, pour le dénudage rapide des fils et câbles, lame en acier inoxydable.

Navajas de electricista  
Para cables con 2 mangos componentes para pelar los alambres y los cables de forma rápida, hoja de acero inoxidable.

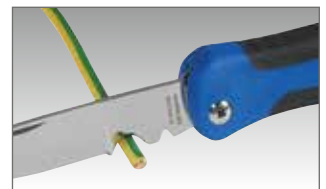

Bestell-No./Order-No.	Art. No.	CLD mm	g	mm	€
50816680000	5081668	115 - 195	75	1	13,65





## 5081835

### Wasserwaage

Aus 2-K Kunststoff mit Schutz durch Weichkomponente und Aluminiumsockelleiste, magnetisch, für eine exakte Auflage. Libellen für waagrecht, senkrecht und 45° Messungen. Prismatische Messfläche.

### Spirit Level

Made of 2-K plastic protected through soft component and aluminium base board, magnetic, plumb vial, horizontal vial, vial for 45° measurements, prismatic measurement surface.

### Waterpas

Van 2 componenten kunststof met bescherming door soft componenten en aluminium bodemstrip, magnetisch. Libel voor horizontale, verticale en 45° metingen prismaatich meetoppervlak.

### Niveau à bulle

En plastique à 2 composantes avec protection par matières souples et profil en aluminium, magnétique, pour un appui précis, niveau à bulle d'air pour mesure horizontale, verticale et à 45°, surface de mesure prismatique.

### Nivel de agua

Hecho en plástico de dos componentes protegido mediante componente blando y rodapié de madera, magnético, nivel de burbuja para mediciones en horizontal, vertical y en 45°, superficie de medición prismática.



Bestell-No./Order-No.	Art. No.	CLD mm			€
<b>50818350000</b>	5081835	230	110	1	<b>8,35</b>

## 5081835-1

400 mm

### Wasserwaage

3 Libellen. Starkes Alu-Rechteckprofil mit Verstärkungsrippen, Pulverbeschichtung, Stoßdämpfende Endkappen und Messkala.

### Spirit Level

3 vials. Strong aluminium rectangular profile with reinforcing fins, powder coating, shock-absorbing end caps and measurement scale.

### Waterpas

3 libellen. Robuust aluminium kokerprofiel met versterkingsribben, poedercoating, schokabsorberende einkappen en maatverdeling.

### Niveau à bulle

3 libellules. Profil rectangulaire renforcé par les rainures. Profil fort rectangulaire au nervures de renfort rectangulaire. Embouts anti-choc, avec graduation.

### Nivel de agua

3 ampollas. Perfil rectangular robusto de aluminio, con nervios de reforzamiento, pintado en epoxy, topes de protección y escala de medición.



Bestell-No./Order-No.	Art. No.	CLD mm			€
<b>50818350100</b>	5081835-1	400	250	1	<b>16,85</b>



## 5081669

18 mm

### Cuttermesser

Aus 2-K Kunststoff, mit Feststellrad und integriertem Klingenmagazin, selbstladend, 5-fach bestückt, inkl. Klingenbrecher und Bleistiftanspitzer.

### Utility knife

Made of 2-K plastic with integrated blade magazine, consisting of 5 pcs., inclusive blade breaker and sharpener.

### Breekmes

Van 2 componenten kunststof, met automatische vergrendeling en geïntegreerd magazijn voor reserve messen, zelfladend, incl. 5 messen, met mesbreker en puntenslijper.

### Cutter

En plastique à 2 composantes, avec chargeur de 5 lames, casse-lame et taille-crayon inclus.

### Cutter

De plástico de 2 componentes con compartimento para almacenamiento de hojas, con 5 funciones, incluidas rompehojas y sacapuntas.



Bestell-No./Order-No.	Art. No.	CLD mm	⚖️	📦	€
<b>50816690000</b>	5081669	170	147	1	<b>7,95</b>
* <b>50816691200</b>	5081669-12	170	2093	12	<b>73,05</b>

\*Lieferung im Verkaufsdisplay • Delivery in sale display

## 50818360300

300 mm

**NEW**

### Präzisions-Maßstab, 300 mm

Aus Aluminium, mit Aufhängeloch, metrische und Zoll Skala.

### Precision rule,

300 mm

Made of aluminium, with hanging hole, metric and inch scale.

### Maatlat,

300 mm

Van aluminium, met ophangoog, metrische en inch maatverdeling.

### Règlet de précision,

300 mm

En aluminium, avec perforation d'accroche, échelle métrique et en pouce.

### Regla de precision,

300 mm

Escala de aluminio, con agujero para colgar, escala métrica y en pulgadas.

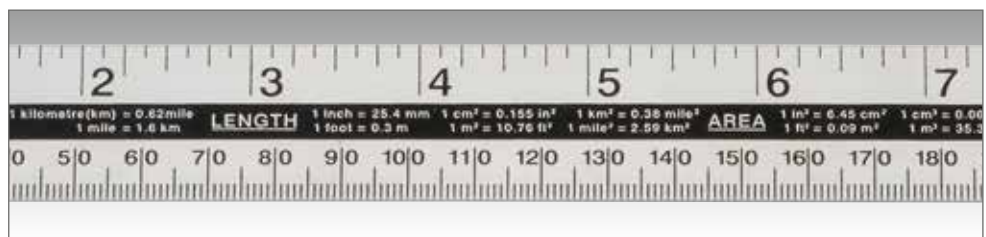

Bestell-No./Order-No.	CLD mm / "	Maße · Dimensions	⚖️	📦	€
<b>50818360300</b>	300 / 11,8	320 x 25 x 2 mm	30	1	<b>3,60</b>

## 5081836

### Zimmermannswinkel

- Hochwertiger Zimmermannswinkel aus Aluminium mit Lineal aus rostfreiem Stahl
- Anschlagschenkel mit Gehrung zum Anreißen von 45° und 90° Linien

### Carpenter's square

- High-quality aluminium Carpenter's Square with stainless steel blade ruler
- Handle with integrated 45°-angle for easy marking of 45° and 90°-lines

### Schrijfhaak

- Hoogwaardige aluminium schrijfhaak met rvs lineaal
- Handgreep met geïntegreerde 45° hoek voor het eenvoudig aangeven van 45° en 90° lijnen

### Equerre de menuisier

- Equerre de menuisier de haute qualité en aluminium avec règle en acier inoxydable
- Poignée intégrée angle 45° pour marquage facile de lignes à 45° et 90°

### Escuadra de carpintero

- Aluminio de alta calidad, escuadra de carpintero con hoja de acero inoxidable
- Mango con ángulo de 45° integrado, para facilitar el marcado en 45° y 90°

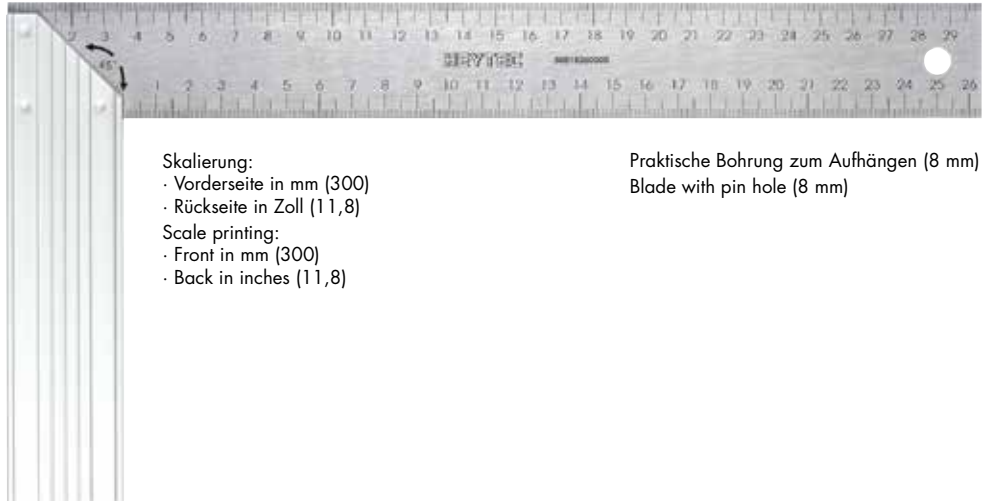

Skalierung:  
 · Vorderseite in mm (300)  
 · Rückseite in Zoll (11,8)

Scale printing:  
 · Front in mm (300)  
 · Back in inches (11,8)

Praktische Bohrung zum Aufhängen (8 mm)  
 Blade with pin hole (8 mm)

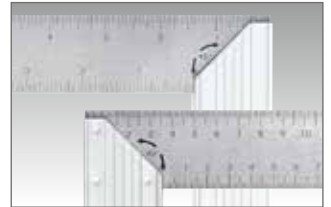

Bestell-No./Order-No.	Art. No.	CLD mm / "	⚖️	📦	€
<b>50818360000</b>	5081836	300 / 11,8	250	1	<b>11,55</b>

## 5081839-3

### Bandmaß, 3 m

ABS Kunststoff Gehäuse. Softgrip Gummibeschichtung für sicheren Halt. Magnetischer Endhaken, verschiebbar für Innen- und Außenmessung. Stopfunktion. Gürtelclip. Handschlaufe.

### Measuring tape, 3 m

ABS plastic housing. Softgrip rubber coating for a secure grip. Magnetic hook, moveable for internal and external gauging. Stopping function. Belt clip. Hand strap.

### 3 meter rolbandmaat

ABS kunststof huis. Softgrip rubberen mantel voor stevige grip. Magnetische haak, verstelbaar voor binnen- en buitenmeting. Stopfunctie. Riemclip. Polskoord.

### Mesure de poche, 3 m

Boîtier en plastique ABS revêtu softgrip pour une bonne prise en main. Crochet magnétique, réglable pour mesure intérieure et extérieure. Fonction d'arrêt. Clip ceinture.

### Flexómetro de 3 metros

Caja de plástico ABS. Recubierto de goma blanda para un agarre seguro. Gancho imantado ajustable para medición interior y exterior. Función de parada. Clip para el cinturón. Con asa para colgar de la muñeca.



Bestell-No./Order-No.	Art. No.	Messbereich · Measuring range	⚖️	📦	€
<b>50818393000</b>	5081839-3	3 m	125	1	<b>5,20</b>
* <b>50818393200</b>	5081839-12	3 m	1500	12	<b>55,85</b>

\*Lieferung im Verkaufsdisplay • Delivery in sale display

## 50816852000

4 in 1

**NEW**

### 4 in 1 Universal Handfeile

Als Flach- und Halbrundfeile ausgeführt. Fein- und Raspelhieb. Einfache Anwendung und Handhabung. Für Holz, Kunststoff, Metall, Horn und ähnliche Materialien.

### 4 in 1 Universal hand file

With flat and halfround file. Fine and rasp cut. Easy application. For wood, plastic, metal, horn and similar materials.

### 4 in 1 Iniversele handvijl

Als vlakke en halfronde vijl uitvoering - zoet en raspvijl - eenvoudig te gebruiken en hanteren - voor hout, kunststof, metaal, hoorn en vergelijkbare materialen.

### 4 in 1 Lime universelle à main

Un côté plat, un côté rond. Un côté râpe, un côté lime. Pour le bois, le plastique, le métal, et autres matériaux.

### 4 en 1 Lima manual universal

Corte fino y raspado. Fácil de usar y y la manipulación. Para la madera, el plástico, metal, cuerno y materiales similares.

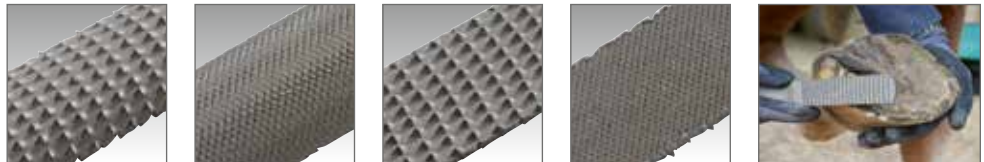

Bestell-No./Order-No.	CLD mm	Maße · Dimensions			€
<b>50816852000</b>	185	200 x 20 x 5 mm	185	1	<b>3,20</b>

## 5081675-79

### Werkstattfeilen

Hieb 2, mit ergonomischem 2-K Softgriff und integrierten Aufhängeösen.

### Engineers' files

With ergonomic 2-K plastic handle and integrated hanging hole for easy storage.

### Werkplaatsvijlenset

Halfzoet, met ergonomische 2 componenten soft-grip en geïntegreerd ophangoog.

### Limes d'atelier

Avec poignée ergonomique souple à 2 composantes et trou de suspension inclus.

### Limas

Mango plástico ergonómico 2 componentes y colgador para un fácil almacenaje.



Bestell-No./Order-No.	Art. No.		CLD mm			€
<b>50816752000</b>	5081675		200	220	1	<b>6,50</b>
<b>50816762000</b>	5081676		200	220	1	<b>7,85</b>
<b>50816772000</b>	5081677		200	220	1	<b>6,50</b>
<b>50816782000</b>	5081678		200	220	1	<b>7,10</b>
<b>50816792000</b>	5081679		200	220	1	<b>6,50</b>

### 5081680

5-tlg./pcs./-dlg./pces./pzs.

#### Werkstattfeilen-Satz

Hieb 2, 8"/200 mm  
in Rolltasche mit Aufhängeösen.

#### Engineer files set

8"/200 mm in wallet and hanging hole.

#### Werkplaatsvijlenset

Halfzoet, 8"/200 mm  
in rolltas met ophangogen.

#### Jeu de limes d'atelier

8"/200 mm en trousse  
avec trou de suspension.

#### Juego de limas

8"/200 mm en bolsa  
enrollable con ojal para colgar.



Bestell-No./Order-No.	Art. No.	Ø mm	g	1	€
<b>50816800500</b>	5081680	200	1100	1	<b>40,35</b>

### 5081440

#### Werkzeugsatz mit Meißel, Körner, Splint- und Durchtreiber

In klappbarer Metallkassette.

Chisel and pin punch set  
In hinged metal box.

Gereedschapset met beitels,  
centerpunt, pendrijver en  
doorslagen

In metalen cassette.

Composition de burins,  
bédanes et chasse-goupille  
En boîte métallique, repliable.

Conjunto de herramientas  
compuesto de cortafíos,  
granetes y punzones cilíndricos  
En caja metálica plegable.



Bestell-No./Order-No.	Art. No.	enthaltend · containing		g	1	€
<b>50814400000</b>	5081440	1	Ø 3 x 120 mm	715	1	<b>26,35</b>
		1	Ø 5 x 150 mm			
		1	Ø 3 x 120 mm			
		1	5 x 130 mm			
		2	12 x 130 mm 14 x 150 mm			

### 50830

#### Splinttreibersatz

In klappbarer Metallkassette.

Pin punches set  
In hinged metal box.

#### Pendrijverset

In metalen cassette.

Jeu de chasses-goupilles  
En boîte métallique, repliable.

Juego de punzones cilíndricos  
En caja metálica plegable.



Bestell-No./Order-No.	Art. No.	enthaltend · containing		g	1	€
<b>50830000000</b>	50830	6	Ø 3 / 4 / 5 / 6 / 7 / 8 x 150 mm	690	1	<b>26,35</b>

## 5082250

### Multifunktions-Abziehersatz

In Kunststoffbox. Grundplatte aus Spezialguß, Abzugsarme und Spindel aus Chrom-Molybdän-Stahl, verwendbar als 2- und 3-armige Innen-/Außenabzieher in 8 Varianten, Belastung als 2-armiger Abzieher: 25000 N - VPA getestet.

### Multifunction pullers

In plastic box. Bridge made of special cast iron, puller legs and screw axis made of chrom-molybdenum, usable in 8 options with 2 or 3 legs for internal or external applications stability under load: 25000 N - VPA tested.

### Multifunctionele trekkerzet

In kunststof koffer. Brug van speciaal gietijzer, haken en spindel van chrom-molybdeenstaal, te gebruiken als 2- en 3-armige binnen-/buitentrekker in 8 varianten belasting als 2-armige trekker: 25000 N - VPA getest.

### Jeu d'extracteurs multifonctions

En coffret plastique. Support en fonte spéciale, bras extracteurs et axe en acier au chrome-molybdène, utilisable en 8 variantes avec 2 ou 3 bras en prise extérieure ou intérieure, stabilité sous charge 25000 N - Testé VPA.

### Juego de extractores multifunción

En estuche de plástico. Placa base de fundición especial, brazos y husillo de acero al cromo molibdeno, sirve como extractor interior y/o exterior de 2 y 3 brazos en 8 variables. Estabilidad bajo carga como extractor de dos brazos verificado VPA - 25000 N.

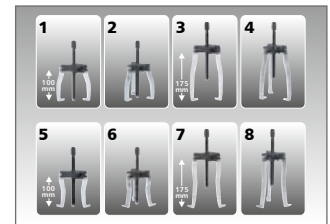
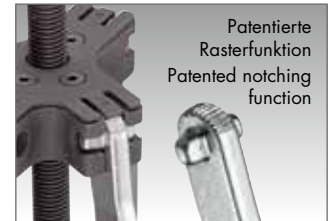

1 Abzieherbrücke  
1 Gewindespindel  
Je 3 Abzieharme

1 Support bridge  
1 Screw axis  
Each 3 puller legs

1 Trekkerbrug  
1 Draadspindel  
elk 3 trekhaken

1 Portique de support  
1 Axe fileté  
3 bras extracteurs de chaque

1 Puente de amarre  
1 Husillo  
3 brazos de extracción de cada

Bestell-No./Order-No.	Art. No.			€
<b>50822500780</b>	5082250	2635	1	<b>168,30</b>

## 5081490

16-tlg./pcs./-dlg./pces./pzs.

### HSS-Gewindeschneidsatz

Chrom-Vanadium, verchromt, in Metallkasten, mit 2-K Schaumstoffeinlagen.

### HSS Die cutting set

Chrome-Vanadium, chromium plated, in metal case, with 2 components foam inserts.

### HSS tap- en draadsnijset

Chroom-Vanadium, verchromd, in metalen kist, met 2 componenten schuimvulling.

### Coffret de filetage HSS

Chrome-Vanadium, chromées, en coffret métallique, avec intérieur mousse bicolore.

### Set de rosca cortante de acero HSS

Cromo Vanadio, cromadas, en caja metálica con material de espuma 2 componentes alta gama.



Bestell-No./Order-No.	Art. No.	Maße - Dimensions			€
<b>50814900000</b>	5081490	220 x 110 x 45 mm	435	1	<b>115,40</b>

Bestell-No./Order-No.	Art. No.	Maße - Dimensions			€
<b>50814922000</b>	5081492-20	M3 - M10	149	1	<b>18,85</b>
<b>50814912000</b>	5081491-20	M3 - M8	52	1	<b>9,75</b>
<b>50814913000</b>	5081491-30	M5 - M10	83	1	<b>12,40</b>
<b>50814910400</b>	5081491-04	M4	5	1	<b>3,85</b>
<b>50814910500</b>	5081491-05	M5	6	1	<b>3,85</b>
<b>50814910600</b>	5081491-06	M6	10	1	<b>3,85</b>
<b>50814910800</b>	5081491-08	M8	16	1	<b>3,85</b>
<b>50814911000</b>	5081491-10	M10	23	1	<b>3,85</b>
<b>50814920400</b>	5081492-04	M4	26	1	<b>2,60</b>
<b>50814920500</b>	5081492-05	M5	26	1	<b>2,60</b>
<b>50814920600</b>	5081492-06	M6	24	1	<b>2,60</b>
<b>50814920800</b>	5081492-08	M8	22	1	<b>3,30</b>
<b>50814921000</b>	5081492-10	M10	20	1	<b>3,30</b>
<b>50825018083</b>	50825-00-18	1/4"	146	5	<b>27,75</b>

Ø 25 mm

### Ersatzteile

Spare parts

Onderdelen

Pièces de rechange

Piezas de repuesto

## 50834

5/32"

31-tlg./pcs./dlg./pcs./pzs.

### Feinmechaniker-Bitsatz

Chrom-Vanadium, verchromt,  
in Kunststoffbox. 5/32" Aufnahme.

### Precision bit-set

Chrome-Vanadium, chromium plated,  
in plastic box. 5/32".

### Precisie bitset

Chroom-Vanadium, verchromd,  
in kunststof koffer. 5/32".

### Embouts de précision

Chrome-Vanadium, chromés,  
en coffret plastique, entraînement 5/32".

### Juego brocas - Mecánico de precisión

Cromo Vanadio, cromadas,  
en caja de plástico. 5/32".



enthaltend/containing

144 mm / 5/32"

PH 000 / 00 / 0 / 1

PZ 0 / 1

0,7 / 0,9 / 1,3 / 1,5 / 2 / 2,5 / 3 / 4

1 / 1,5 / 2 / 2,5 / 3 / 3,5 / 4

TX 4 / 5 / 6 / 7 / 8 / 9 / 10 / 15 / 20



Bestell-No./Order-No.	Art. No.	Maße - Dimensions	g	Stk	€
<b>5083400000</b>	50834	155 x 105 x 40 mm	396	1	<b>51,85</b>

5/32"

### Ersatzteile

Spare parts

Onderdelen

Pièces de rechange

Piezas de repuesto



50834-32



50834-35



50834-31



50834-30



50834-37

Bestell-No./Order-No.	Art. No.	Maße - Dimensions	g	Stk	€
<b>50834000100</b>	50834-1	144 mm / 5/32"	47	1	<b>11,25</b>
<b>50834320400</b>	50834-32	PH 000/00/0/1	16	1	<b>3,40</b>
<b>50834350200</b>	50834-35	PZ 0/1	5	1	<b>1,70</b>
<b>50834310800</b>	50834-31	0,7/0,9/1,3/1,5/2/2,5/3/4	41	1	<b>5,65</b>
<b>50834300700</b>	50834-30	1/1,5/2/2,5/3/3,5/4	10	1	<b>3,90</b>
<b>50834370900</b>	50834-37	TX 4/5/6/7/8/9/10/15/20	21	1	<b>5,10</b>

## 50835

DIN 5265 / 8764

16-tlg./pcs./dlg./pcs./pzs.

### Feinmechaniker-

### Schraubendrehersatz

Ergonomischer 2-K Softgriff mit drehbarer  
Kappe. Klingen aus Chrom-Molybdän-  
Stahl, gehärtet und geschwärzt.

### Precision screwdriver set

2-K Screwdriver. Ergonomic soft grip  
with rotatable cap. Blades made of  
chrom-molybdenum steel, hardened, with  
black tip.

### Precisie schroeven-draaierset

Ergonomische 2-K softgreep met  
draaibare kap. Klingen uit chroom-  
molybdeen staal, gehard en gezwart.

### Jeu de tournevis de mécanicien de précision

Tournevis 2 composants. Manche  
softgripp ergonomique avec embout  
rotatif. Lames acier Chrom-Molybdène  
trempés et noirci.

### Juego de destornilladores para mecánico

En bolsa enrollable, destornillador con  
mango de dos componentes. Mango  
ergonómico con tope giratorio. Hojas de  
acero al cromo molibdeno, templadas y  
fosfatadas.



enthaltend/containing

PH 000 / 00 / 0

0,9 / 1,5 / 2 / 2,5 / 3

1,5 / 2 / 2,5

TX 4 / 5 / 6 / 7 / 8

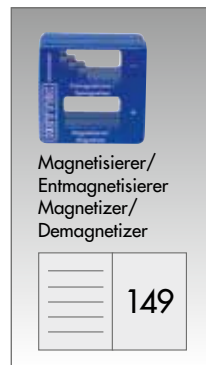

Magnetisierer/  
Entmagnetisierer  
Magnetizer/  
Demagnetizer

149



In Rolltasche. In wallet.

Bestell-No./Order-No.	Art. No.	Maße - Dimensions	g	Stk	€
<b>50835000000</b>	50835	230 x 115 x 50 mm	420	1	<b>55,05</b>



## DIN 5265 / 8764

- Ergonomischer 2-K Softgriff. Klinge aus Chrom-Molybdän-Stahl, gehärtet und geschwärzt.
- With ergonomic 2 components soft grip plastic handle, blades from chrom-molybdenum steel, hardenend, with black tip.
- Ergonomische 2-K softgreep, kling uit chroom-molybdeenstaal, gehard en gezwart.
- Tournevis à poignée ergonomique bimatière, lame en chrome-molybdène, trempée, et bout bruni.
- Destornilladores según mango ergonómico de dos componentes varillas de acero al cromo molib-deno, templadas y pavonadas.



### 5084511 - 5084530

#### 2-K Werkstatt-Schraubendreher

Workshop screwdrivers

2 Componenten werkplaats schroevendraaier

Tournevis

Destornilladores de taller



Bestell-No./Order-No.	Art. No.	⊖	+	*	⚖	📦	€
<b>50845110180</b>	5084511		PH 1		60	10	<b>6,15</b>
<b>50845110280</b>	5084511		PH 2		100	10	<b>6,95</b>
<b>50845120180</b>	5084512			PZ 1	60	10	<b>6,15</b>
<b>50845120280</b>	5084512			PZ 2	100	10	<b>6,95</b>
<b>50845300480</b>	5084530	0,8 x 4,0 x 75 mm			40	10	<b>5,65</b>
<b>50845305580</b>	5084530	1,0 x 5,5 x 125 mm			80	5	<b>6,45</b>
<b>50845306580</b>	5084530	1,2 x 6,5 x 150 mm			100	5	<b>7,35</b>

### 5084564

5-tlg./pcs./-dlg./pces./pzs.

#### 2-K Werkstatt-Schraubendreher-Satz

Workshop screwdrivers set

2 Componenten werkplaats schroevendraaier-set

Jeu de Tournevis

Destornilladores de taller



Bestell-No./Order-No.	Art. No.	⊖ + +	⚖	📦	€
<b>50845640080</b>	5084564	0,8 x 4,0 x 75 mm, 1,0 x 5,5 x 125 mm, 1,2 x 6,5 x 150 mm + PH 1, PH 2	460	1	<b>26,35</b>

### 5084515

#### TORX®-Schraubendreher

TORX®-Screwdrivers

TORX® schroevendraaier

TORX®-Tournevis

TORX®-Destornilladores



Bestell-No./Order-No.	Art. No.	*	⚖	📦	€
<b>50845151080</b>	5084515	T 10	63	10	<b>5,60</b>
<b>50845151580</b>	5084515	T 15	63	10	<b>5,60</b>
<b>50845152080</b>	5084515	T 20	63	10	<b>5,95</b>
<b>50845152580</b>	5084515	T 25	87	5	<b>6,45</b>
<b>50845152780</b>	5084515	T 27	87	5	<b>6,45</b>
<b>50845153080</b>	5084515	T 30	87	5	<b>6,75</b>
<b>50845154080</b>	5084515	T 40	97	5	<b>7,20</b>

### 5084560

7-tlg./pcs./-dlg./pces./pzs.

#### TORX®-Schraubendreher-Satz

Set of TORX®-Screwdrivers

TORX® schroevendraaier-set

Jeu de tournevis TORX®

Juego de destornilladores TORX®



Bestell-No./Order-No.	Art. No.	*	⚖	📦	€
<b>50845600080</b>	5084560	T 10 / T 15 / T 20 / T 25 / T 27 / T 30 / T 40	680	1	<b>45,50</b>



## 5083301-1

### Magnet Bithalter

Chrom-Molybdän, verchromt. Mit 2-K Kunststoffgriff. Mit Dauermagnet. Extrem schmale Ausführung.

### Magnetic bitholder

Chrom-molybdenum, chromium. With ergonomic 2-K plastic handle. With permanent magnet. Extremely slim shape.

### Bitadapter

Chroom-molybdeenstaal, verchromd. Met permanente magneet. Extrem smalle uitvoering.

### Poignée porte-embouts magnétique

Chrom-molybdène, chromé. Avec poignée ergonomique souple à 2 composantes. Aimant permanent. Tête ultra mince.

### Adaptador de puntas

Cromo molibdeno, cromadas. Mango plástico ergonómico 2 componentes. Con imán permanente. Diseño extremadamente delgado.



Sicherheitsarretierung durch Dauermagnet und formschlüssige Arretierung. Einfache Entnahme durch Auswurfbetätigung. Ideal geeignet für enge, schwer zugängliche Stellen.  
Safety locking by permanent magnet and positive locking. Easy removal by actuating the ejection. Best suited for tight places with difficult access.

Bestell-No./Order-No.	Art. No.	CL Ø mm	g	mm	1	€
<b>50833010080</b>	5083301-1	200	240	1	<b>12,50</b>	

## 5080542

### Steckschlüssel

Mit Quergriff und Aufhängebohrung, für Aussensechskantschrauben, Spezial Stahl.

### Nut spinner

With T-handle and hang-up hole for hexagon socket screws, special steel.

### Dopschroevendraaier

Met T-greep en ophangoog, voor zeskantbouten, speciaal staal.

### Tournevis en T à douille

Poignée ergonomique à 2 composants, lame en acier spécial.

### Llaves de vaso

Con mango transversal con agujero, para tuercas y tornillos de cabeza exagonal, acero especial.



Bestell-No./Order-No.	Ø MM	CL Ø mm	L1 mm	L2 mm	T mm	g	mm	5	€
<b>50805425580</b>	5,5	260	230	95	21,0	104	5	<b>7,05</b>	
<b>50805420680</b>	6	260	230	95	21,0	106	5	<b>7,05</b>	
<b>50805420780</b>	7	260	230	95	21,0	107	5	<b>7,65</b>	
<b>50805420880</b>	8	270	230	115	26,0	236	5	<b>8,05</b>	
<b>50805420980</b>	9	270	230	115	26,0	240	5	<b>8,15</b>	
<b>50805421080</b>	10	270	230	115	26,0	242	5	<b>8,15</b>	
<b>50805421180</b>	11	270	230	115	26,0	248	5	<b>8,95</b>	
<b>50805421280</b>	12	270	230	115	26,0	252	5	<b>8,95</b>	
<b>50805421380</b>	13	270	230	115	26,0	262	5	<b>9,20</b>	

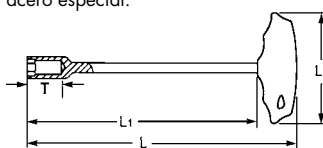

## R 5080542-9

9-tlg./pcs./-dlg./pces./pzs.

### Steckschlüsselsatz

In Polyesterrolltasche, mit Textilbindeschleifen und Aufhängeösen.

### Nut spinner set

Polyester wallet with textile strap and suspension eyelet.

### Dopschroevendraaierset

In polyester roltaas, met sluitriemen en ophangogen.

### Jeu de tournevis en T à douilles

Trousse en polyester avec lanière textile et œillet de suspension.

### Juego de llaves de vaso con mango

En bolsa enrollable de poliestireno, con cintas de cierre y ojal para colgar.

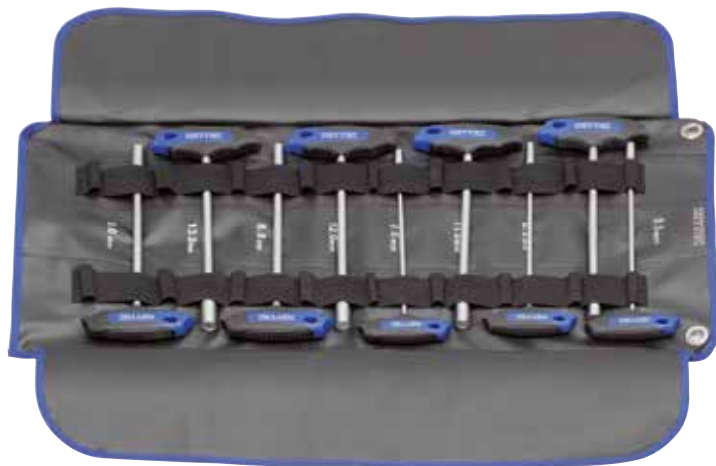

Bestell-No./Order-No.	Art. No.	enthaltend · containing	g	mm	1	€
* <b>50805429080</b>	R 5080542-9	MM 5,5/6/7/8/9/10/11/12/13	2635	1	<b>87,00</b>	

\* Auslauf / Discontinued

- Spezial Stahl
- Special steel
- Special steel
- Acier spécial
- Acero especial

## 5081338

### Sechskant-Schraubendreher

Mit Quergriff und Aufhängebohrung, für Innensechskant-schrauben.

### Hexagonal head wrench

With T-handle and hang-up hole for hexagon socket screws.

### Stiftsleutel zeskant

Met T-greep en ophangoog, voor binnenzeskantbouten.

### Tournevis hexagonal

Avec poignées en T et trou de suspension pour vis hexagonales.

### Destornilladores exagonales

Con mango transversal con agujero, para tornillos y tuercas de cabeza exagonal.

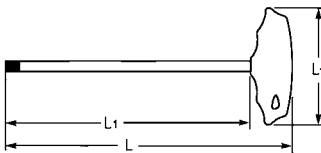

Bestell-No./Order-No.	MM	CLD mm	L1 mm	L2 mm	g	pcs	€
50813380280	2	130	100	75	19	5	3,95
50813382580	2,5	130	100	75	21	5	4,35
50813380380	3	130	100	75	23	5	4,45
50813380480	4	180	150	75	35	5	4,80
50813380580	5	180	150	95	65	5	5,05
50813380680	6	185	150	95	79	5	6,00
50813380880	8	230	200	95	135	5	6,10
50813381080	10	240	200	115	225	5	7,15

## H 5081338-8

8-tlg./pcs./dlg./pces./pzs.

### Sechskant-Schraubendrehersatz

Mit Aufhängebohrungen.

Set of hexagonal head wrenches

With hang-up hole.

Stiftsleutelset zeskant met T-greep

Met ophangogen.

Jeu de tournevis hexagonaux

Avec trou de suspension.

Juego de destornilladores exagonales

Con agujeros para colgar.



Im Metallhalter  
In metal holder  
170 x 120 x 245 mm

Bestell-No./Order-No.	Art. No.	MM	g	pcs	€
50813380080	H 5081338-8	2/2,5/3/4/5/6/8/10	920	1	49,15

## H 5081340-7

### Winkelschraubendrehersatz

Im Handklapphalter, kunststoffbeschichtet, für Innensechskantschrauben.

Set of hexagonal head wrenches

In metal holder, plastic coated for hexagon socket screws.

### Stiftsleutelset

Zakmesmodel, kunststof houder, voor binnenzeskant bouten.

Jeu de clés mâles

Sur montage, revêtement plastique, pour vis à pans creux.

Juego de llaves Allen

En soporte plegable, plastificadas, para tornillos Allen interiores.



Lieferung in Blisterverpackung.  
Supplied in blister packing.



Bestell-No./Order-No.	Art. No.	MM	g	pcs	€
50813406280	5081340-7	1,5/2/2,5/3/4/5/6	134	5	10,50

- Spezial Stahl
- Special steel
- Special steel
- Acier spécial
- Acero especial

### HP 5081343-9

9-tlg./pcs./-dlg./pces./pzs.

#### Kugelpf-Winkelschraubendreheratz

Im Kunststoffhalter, für schwer zugängliche Innensechskantschrauben.

Set of ball head hexagonal wrenches

In plastic holder for hexagon socket screws in confined or hard to reach areas.

Stiftsleutelset kogelkop

In kunststof houder, voor moeilijk bereikbare binnen-zeskant bouten.

Jeu de clés mâles coudées à tête sphérique

Sur monture plastique, pour vis 6 pans creux avec accès difficile.

Juego de llaves Allen con cabeza esférica

En soporte de plástico, para tornillos Allen interiores de difícil acceso.

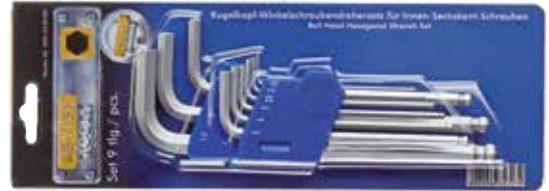
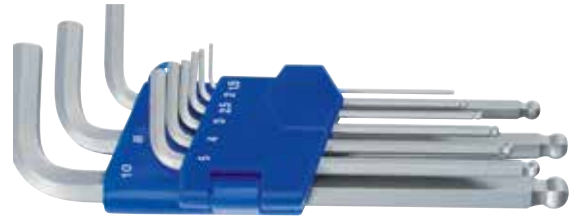
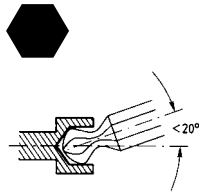

Lieferung in Blisterverpackung.  
Supplied in blister packing.

Bestell-No./Order-No.	Art. No.	MM	$\text{CL} \varnothing$ mm	g		€
<b>50813438280</b>	HP 5081343-9	1,5/2/2,5/3/4/5/6/8/10	185	353	5	<b>14,70</b>

### HP 5081344-9

9-tlg./pcs./-dlg./pces./pzs.

#### Kugelpf-Winkelschraubendreheratz, lang

Set of ball head hexagonal wrenches, long

Stiftsleutelset kogelkop, lang

Jeu de clés mâles coudées à tête sphérique, long

Juego de llaves Allen con cabeza esférica, largo

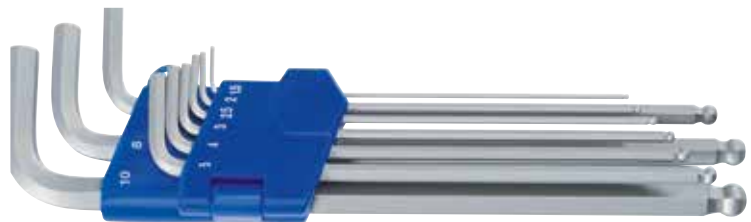

Lieferung in Blisterverpackung.  
Supplied in blister packing.

Bestell-No./Order-No.	Art. No.	MM	$\text{CL} \varnothing$ mm	g		€
<b>50813448280</b>	HP 5081344-9	1,5/2/2,5/3/4/5/6/8/10	235	470	5	<b>18,50</b>

### 5081347

#### TORX®-Schraubendreher

Mit Quergriff und Aufhängebohrung, für Innen-TORX®-Schrauben.

TORX®-Screwdrivers

With T-handle and hang-up hole for TORX® socket screws.

TORX® schroevendraaier

Met T-greep en ophangoog voor binnen TORX® bouten.

Tournevis TORX®

Avec poignées en T et trou de suspension pour vis TORX® intérieures.

Destornilladores TORX®

Con mango transversal con agujero para colgar, para tornillos TORX® interiores.



Bestell-No./Order-No.		mm	$\text{CL} \varnothing$ mm	L1 mm	L2 mm	g		€
<b>50813471080</b>	T 10	2,74	125	100	75	27	5	<b>5,05</b>
<b>50813471580</b>	T 15	3,27	125	100	75	28	5	<b>5,05</b>
<b>50813472080</b>	T 20	3,86	125	100	75	28	5	<b>5,05</b>
<b>50813472580</b>	T 25	4,43	130	100	95	62	5	<b>5,60</b>
<b>50813472780</b>	T 27	4,99	130	100	95	63	5	<b>5,45</b>
<b>50813473080</b>	T 30	5,52	235	200	95	85	5	<b>6,00</b>
<b>50813474080</b>	T 40	6,65	235	200	95	123	5	<b>6,95</b>
<b>50813474580</b>	T 45	7,82	285	250	95	142	5	<b>7,30</b>
<b>50813475080</b>	T 50	8,83	290	250	115	315	5	<b>9,55</b>

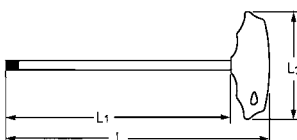

- Spezial Stahl
- Special steel
- Special steel
- Acier spécial
- Acero especial

### H 5081347-9

9-tlg./pcs./-dlg./pces./pzs.



#### TORX®-Schraubendrehersatz

Mit Aufhängebohrungen.

Set of TORX®-Screwdrivers  
With hang-up hole.

TORX® schroevendraaier-set  
met T-greep  
Met ophangogen.

Jeu de tournevis TORX®  
Avec trou de suspension.

Juego de destornilladores  
TORX®

Con agujeros para colgar.

Im Metallhalter  
In metal holder  
195 x 120 x 290 mm



Bestell-No./Order-No.	Art. No.				€
<b>50813470080</b>	5081347-9	T 10/T 15/T 20/T 25/T 27 T 30/T 40/T 45/T 50	1245	1	<b>61,70</b>

### H 5081348-7



#### TORX®-Winkelschraubendrehersatz

Im Handklapphalter, kunststoffbeschichtet,  
für Innen-TORX®-Schrauben.

Set of L-shaped TORX®  
Wrenches

In metal holder, plastic coated  
for TORX® socket screws.

TORX® schroevendraaier-set  
Zakmesmodel, kunststof houder,  
voor binnen TORX® bouten.

Jeu de tournevis TORX®  
Sur monture, revêtement plastique,  
pour vis TORX® intérieures.

Juego de destornilladores  
TORX®

En soporte plegable, plastificadas,  
para tornillos TORX® interiores.

Bestell-No./Order-No.	Art. No.				€
<b>50813486280</b>	5081348-7	T 10/T 15/T 20/T 25/T 27/T 30/T 40	245	1	<b>13,85</b>



Lieferung in Blisterverpackung.  
Supplied in blister packing.



### HP 5081348-9

9-tlg./pcs./-dlg./pces./pzs.



#### TORX®-Winkelschraubendrehersatz

Im Kunststoffhalter.

Set of L-shaped TORX®  
Wrenches

In plastic holder.

TORX® schroevendraaier-set  
In kunststof houder.

Jeu de tournevis TORX® coudés  
Sur monture plastique.

Juego de destornilladores  
TORX®

En soporte de plástico.

Bestell-No./Order-No.	Art. No.				€
<b>50813488280</b>	5081348-9	T 10/T 15/T 20/T 25/T 27 T 30/T 40/T 45/T 50	316	1	<b>18,95</b>



Lieferung in Blisterverpackung.  
Supplied in blister packing.



### HP 5081349-9

9-tlg./pcs./-dlg./pces./pzs.

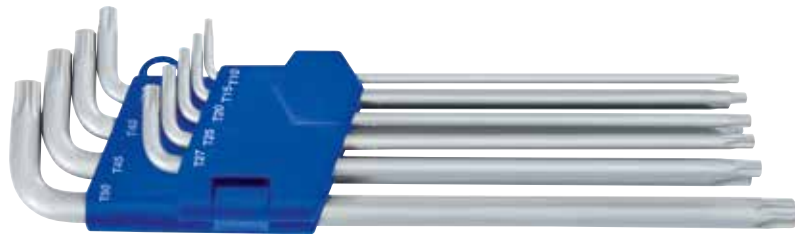

TORX®-Winkelschraubendrehersatz, lang

Set of L-shaped TORX®-Wrenches, long

TORX® schroevendraaier-set, lang

Jeu de tournevis TORX® coudés, long

Juego de destornilladores TORX®, largo

Lieferung in Blisterverpackung.  
Supplied in blister packing.

Bestell-No./Order-No.	Art. No.		CLD mm			€
<b>50813498280</b>	5081349-9	T 10/T 15/T 20/T 25/T 27 T 30/T 40/T 45/T 50	235	480	1	<b>21,05</b>

### 508339

#### Magnetisierer und Entmagnetisierer

Zuverlässiges Entmagnetisieren und Magnetisieren von Schraubendreherklingen, vereinfacht das Ein- + Ausdrehen von Schrauben an schwer zugänglichen Stellen, zum sicheren Arbeiten an empfindlichen elektronischen Bauteilen.

Magnetizer and demagnetizer  
Reliable demagnetize and magnetize of screwdriver blades, simplified the turn of screws on difficult access, for safe work on sensitive components.

Magnetiseren en demagnetiseren

Betrouwbaar demagnetiseren en magnetiseren van schroevendraaierklingen, vereenvoudigt het in- en uitdraaien van schroeven op moeilijk bereikbare plaatsen, voor het veilig werken bij statisch gevoelige elektronische componenten.

Magnétiseur et démagnétiseur  
Démagnétisation et magnétisation fiable de lames de tournevis, simplifie le vissage et le dévissage des vis dans les zones difficiles à atteindre, pour travailler en toute sécurité sur les composants électroniques sensibles.

Imantar y desimantar

Desimantado e imantado fiable de varillas de desatornillado, facilita el atornillado y destornillado en lugares de difícil acceso, trabajo seguro en elementos electrónicos delicados.



Bestell-No./Order-No.	Art. No.	Maße · Dimensions			€
* <b>5083390000</b>	508339	52 x 50 x 29 mm	88	1	<b>3,50</b>

\* Auslauf / Discontinued



- Fibreglasstiel mit Kunststoff-Schutzüberzug, Kopf schwarz lackiert
- Fibreglass handle with plastic coating, black lacquered head
- Glasfiber steel met kunststof mantel, kop zwart gelakt
- Manche en fibre de verre avec protection plastique, tête laquée noir
- Mango de fibra de vidrio plastificado, cabeza pintada de negro



### 5081523 - 5081525

#### Schlosserhämmer

Engineers' hammers

Bankhamers

Marteaux de mécanicien

Martillos de peña

Bestell-No./Order-No.	Art. No.	g	mm	g		€
<b>50815230021</b>	5081523	300	315	500	5	<b>8,30</b>
<b>50815250021</b>	5081525	500	340	700	5	<b>10,85</b>

### 5081518

#### Fäustel

Club hammer

Vuisthamer

Massette

Maza



Bestell-No./Order-No.	Art. No.	g	mm	g		€
<b>50815181021</b>	5081518	1000	260	1290	1	<b>14,30</b>

### 50815180000

#### Gummiaufsatz für Fäustel

Für Fäustel No. 50815181021

Rubber attachment for club hammer

For club hammer No. 50815181021

Rubberen dop voor vuisthamer

Voor vuisthamer no. 50815181021

Embout en caoutchouc pour massette

Pour massette No. 50815181021

Accesorio de goma para mazo

Para el mazo n° 50815181021

**NEW**

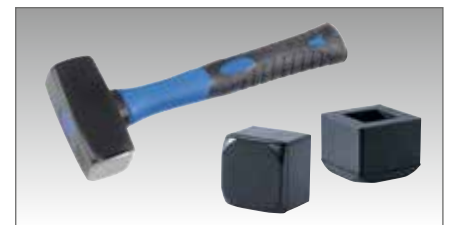

Bestell-No./Order-No.	g	Maße · Dimensions	g		€
<b>50815180000</b>	1000	70 x 70 x 60 mm	307	1	<b>8,25</b>

### 50815182021

#### Pflasterhammer

Fäustel inkl. Gummiaufsatz.

Paving hammer

Paving hammer with rubber cap.

Vuisthamer

Vuisthamer met rubberen dop.

Massette à paver

Massette et embout en caoutchouc.

Mazo de pavimentación

Mazo incl. accesorio de goma.

**NEW**

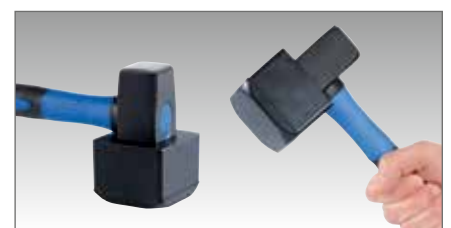

Bestell-No./Order-No.	g	mm	Maße · Dimensions	g		€
<b>50815182021</b>	1000	270	270 x 120 x 72 mm	1698	1	<b>20,10</b>

## 5081516-1

### Latthammer

Kopf schwarz lackiert, mit kariert-gefräster Bahn, eingeschmiedetes Nagelbett mit Magnethalterung, 2-K Kunststoffgriff.

### Carpenter hammer

Head black lacquered, with chequered-milled face, with magnetic nail holder, 2-component plastic handle.

### Lattenhamer

Met zwart gelakte, geribbelde kop, ingesmede magnetische spijkerhouder, 2 componenten kunststof greep.

### Marteau de charpentier

Tête laquée noire, avec face fraisée en gaufrage, glissière pour clou incorporée et forgée, avec maintien magnétique, poignée antidérapante.

### Martillo de carpintero

Cabezal negro lacado, con cara grafilada, canal imantado de sujeción de clavos, mango de plástico de dos componentes.



Bestell-No./Order-No.	Art. No.	g	mm	g		€
<b>50815160120</b>	5081516-1	600	315	841	1	<b>20,10</b>

## 5081516

### Ganzstahl-Latthammer

Mit kariert-gefräster Bahn, eingeschmiedetes Nagelbett mit Magnethalterung, 2-K Kunststoffgriff, Kunststoffschutzkappe an der Pinne.

### Whole steel carpenter hammer

With draughted milled face, built-in forged magnetic nail holder slider, 2-components plastic handle, peen protected with a plastic sleeve.

### Geheel stalen lattenhamer

Met geribbelde kop, ingesmede magnetische spijkerhouder, 2 componenten kunststof greep, kunststof beschermkap op de pinne.

### Marteau de charpentier tout acier

Avec face fraisée en gaufrage, glissière pour clou incorporée et forgée avec maintien magnétique, poignée à 2 composants, pointe protégée par un manchon en plastique.

### Martillo de carpintero, enteramente de acero

Con cara grafilada, canal imantado de sujeción de clavos, mango de plástico de dos componentes, funda de protección de plástico para la uña.



Bestell-No./Order-No.	Art. No.	g	mm	g		€
<b>50815160021</b>	5081516	600	330	925	1	<b>41,30</b>



### 5081530

Shore D 66±5  
Shore D 45±5

#### Kunststoff-Schonhammer

Hickory-Stiel, auswechselbare Köpfe in 2 Härten.

#### Plastic hammers

Hickory handle, exchangeable heads in 2 hardnesses.

#### Kunststof hamer

Hickory steel, verwisselbare koppen in 2 hardheden.

#### Massettes avec embouts en plastique

Poignée hickory, tête interchangeable en 2 duretés.

#### Martillos con bocas de plástico

Mango Hickory, cabezas intercambiables en dos durezas.



Bestell-No./Order-No.	Art. No.	Ø	CLD mm			€
<b>50815302700</b>	5081530-27	27	270	278	2	<b>30,15</b>
<b>50815303500</b>	5081530-35	35	300	390	2	<b>35,00</b>

### 5081531

Shore D 66±5

#### Ersatzköpfe Kunststoff

Standardmäßig aus Kunststoff (Celluloseacetat) für Kunststoff-Schonhammer, Härte nach Shore D 66±5.

#### Plastic spare heads

Standard, made of plastic (cellulose acetate) for plastic hammers, hardness according to Shore D 66±5.

#### Reservedoppen uit kunststof

Standaard, uit kunststof (cellulose-acetaat) voor kunststof hamers, hardheid volgens Shore D 66±5.

#### Embouts de rechange

en plastique  
Standard, en plastique (acétocellulose) pour massettes, Shore D 66±5.

#### Bocas de recambio

de plástico  
Estándar, de plástico (acetato de celulosa) para martillos con bocas de plástico, Shore D 66±5.



Bestell-No./Order-No.	Art. No.	Ø			€
<b>50815312700</b>	5081531-27	27	18	10	<b>6,60</b>
<b>50815313500</b>	5081531-35	35	23	10	<b>6,60</b>

### 5081532

Shore D 45±5

#### Ersatzköpfe Nylon

Standardmäßig aus schlagfestem Nylon, Härte nach Shore D 45±5.

#### Spare nylon heads

Standard, made of nylon, hardness complying with Shore D 45±5.

#### Reservedoppen nylon

Standaard, uit slagvast nylon, hardheid volgens Shore D 45±5.

#### Embouts de nylon

interchangeables  
Standard, en nylon, Shore D 45±5.

#### Bocas de nylon, de recambio

Estándar con bocas de nylon, Shore D 45±5.



Bestell-No./Order-No.	Art. No.	Ø			€
<b>50815322700</b>	5081532-27	27	12	10	<b>4,85</b>
<b>50815323500</b>	5081532-35	35	23	10	<b>6,05</b>

## 9088070

### Werkzeugrolltasche, leer

Rolltasche mit 15 Facheinteilungen, gefertigt aus schwarzem Polyester, PP-Einfassung in dunkelblau, mit Gurt und Schnalle. Ohne Aufdruck.

### Tool wallet, empty

With 15 compartments made from black polyester with dark blue lining with strap and clasp, neutral.

### Gereedschapsroltas, leeg

Roltas, zonder inhoud, met 15 vakken, vervaardigd uit zwart polyester, donkerblauwe PP afwerking, met sluitriem en gesp. Zonder opdruk.



### Trousse à outils, vide

Trousse à 15 compartiments, en polyester noir, bords bleu foncé avec lanière et boucle, sans impression.

### Bolsa de herramientas, enrollable, vacío

Bolsa enrollable, vacía, con 15 bolsillos, de poliéster negro, bordes de polipropileno azul marino, con cinta y hebilla, neutral.



Bestell-No./Order-No.	Art. No.	Maße · Dimensions			€
<b>90880701500</b>	9088070	670 x 340 mm	750	5	<b>20,00</b>

## 50890-30

8-tlg./pcs./dlg./pces./pzs.

### Haushalts-Werkzeugtasche

Zusammenstellung der gebräuchlichsten Qualitätswerkzeuge für Haushalt und Büro; für zuhause oder unterwegs.

Praktisch und platzsparend, Kunstledertasche mit Verschluss. Optimal auch in der Werbebranche einsetzbar.

### Household tool wallet

Assortment of most commonly used quality tools for office and house-hold, for at home and on the road. Practical and suitably, tool wallet of imitation leather with inter-locking clasp fastener. Particularly suitable for marketing through advertising and publicity companies.

### Gereedschapsset voor thuis

Overzicht van de meest algemene kwaliteitgereedschappen voor gebruik in en om huis en kantoor; voor thuis en onderweg. Praktisch en plaatsbesparend, verpakt in kunstleren tas met sluiting. Ook uitstekend geschikt als reclameobject.

### Trousse d'outillage à usage domestique

Composition d'outillage de qualité pour l'entretien de la maison, du bureau à domicile ou en voyage. Rangés en trousse similicuir pratique et compacte, avec fermoir. Optimal aussi dans le domaine des cadeaux d'affaires.



### Herramientas de calidad

Conjunto de herramientas de calidad, para uso doméstico, en la oficina y de viaje. Presentadas en una bolsa de plástico práctica y de reducidas dimensiones, con cierre. Muy recomendable para regalo publicitario.



#### enthaltend/containing

	200 mm
	300 g
	255 mm
	230 mm
	250 mm
	170 mm
 +	6,5 mm x PH 2
	150 - 250 V

Bestell-No./Order-No.	Art. No.	Maße · Dimensions			€
<b>50890300300</b>	50890-30	480 x 365 x 30 mm	1305	1	<b>86,80</b>

### 50899000560

DIN 22417

#### Dreikant-Steckschlüssel, M5

Aus nahtlos kaltgezogenem Präzisionsstahlrohr, mit durchgestecktem, beweglichem Quergriff, verzinkt.

#### Tubular triangular wrench, M5

Made of seamless, cold-drawn precision steel tube with inserted, movable handle, galvanized.

#### Driekant pijpsleutel, M5

Uit naadloos koud getrokken precisie stalen buis, met doorgestoken, beweegbare greep, verzinkt.

#### Clé triangle de sécurité, M5

En acier à tuyau sans jointure, avec poignée coulissante, galvanisée.

#### Llave de vaso triangular M5

De tubo de acero de precisión trefilado en frío y sin soldadura, con pasador en cruz móvil, galvanizada.



**NEW**



Geeignet zur Fahrstuhl-Notentriegelung.  
suitable for elevator emergency unlocking.

Bestell-No./Order-No.	CLD mm			€
<b>50899000560</b>	200	55	1	<b>6,65</b>

### 50898

DIN 3222/3223

#### Dreikant-Rohrsteckschlüssel

Mit Drehstift, Normdreikant für M10 und M12.

#### Tubular triangular wrench

With tommy bar, for standard M10 and M12 triangulars.

#### Driekante paalsleutel

Met wringstaaf, norm driekant voor M10 en M12.

#### Clé en tube triangulaire

Avec broche, triangle pour M10 et M12.

#### Llave de tubo de boca

triangular  
Con badeador, triángulo normalizado para M10 y M12.

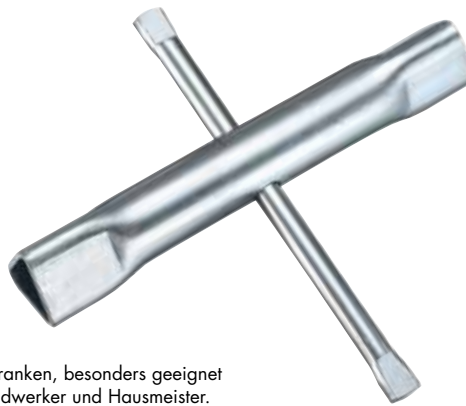

Für Absperrpoller, Schranken, besonders geeignet für Rettungskräfte, Handwerker und Hausmeister.  
Especially for rescue services, craftsmen and facility management applications.



Bestell-No./Order-No.	Art. No.	CLD mm			€
<b>50898101260</b>	50898	140 x 125	175	1	<b>18,95</b>

### 50801329

Ø 65-120 mm

#### Ölfilterspinne

Spezialstahl, geschmiedete Ausführung, Oberfläche verzinkt, universell zu verwenden, für 1/2" und 3/8" Antriebe, SW 22, rechts + links Lauf.

#### Self-gripping oil filter wrench

Special steel, forged pattern, zinc plated for 3/8" and 1/2" square drive, SW 22.

#### Oliefiltertang

Speciaalstaal, gesmede uitvoering, oppervlakte verzinkt, universeel toepasbaar, voor 1/2" en 3/8" aansluiting, SW 22, rechts en links draaiend.

#### Croisillon pour filtre à huile

Acier spécial, modèle forgé, surfaces galvanisées, utilisation universelle, pour entraînements 1/2" et 3/8", SW 22.

#### Filtro de aceite araña

Acero especial, modelo de acero forjado, superficie galvanizada uso universal para accionamiento de 1/2" y 3/8", SW 22.



Bestell-No./Order-No.	Art. No.			€
<b>50801329080</b>	50801329	563	1	<b>21,00</b>

**50815770900**  
**50815771200**

**NEW**

**Hebel- und Montageeisen**

Aus Spezial-Werkzeugstahl für maximale Beanspruchung: Das innovative Oval Doppel-T Profil bietet höchste Festigkeit und einen festen und sicheren Griff. Gewalzte Struktur, geschmiedete Enden.

**Pry bar**

Made from special tool steel for heavy-duty applications: The innovative, oval double-T profile provides highest strength and a particularly safe and secure grip. Forged steel, rolled structure, forged ends.

**Koevoet**

Uit speciaal gereedschapsstaal voor zware toepassingen: het innovatieve, ovale dubbele T-profiel biedt de grootste kracht en stevige grip. Gewalste structuur, gesmede uiteinden.

En acier à outils spécial pour un maximum de sollicitation: l'innovant ovale profilé en double T offre une résistance et une prise ferme et sûre. Structure laminée, extrémités forgées.

**Palanca y plancha de montaje**

Fabricado en acero especial para herramientas, para una máxima durabilidad. El innovador perfil ovalado en doble T ofrece la máxima resistencia y un agarre firme y seguro. Estructura laminada, extremos forjados.

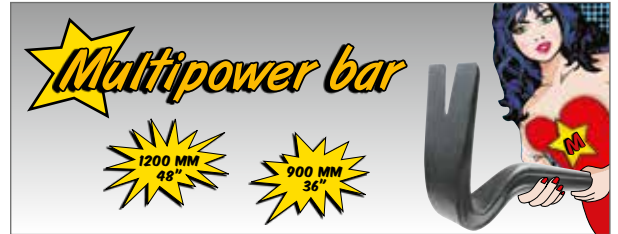

Bestell-No./Order-No.	CLD mm	"	g	g	€
<b>50815770900</b>	900 mm/36"		2990	6	<b>33,85</b>
<b>50815771200</b>	1200 mm/48"		4130	6	<b>41,30</b>

**5081500**

**Montiereisen**

Mit auswechselbarer Kunststoffschiene. Die auswechselbare Kunststoffschiene schützt Aluminium- und lackierte Felgen vor Beschädigung.

**Tyre lever**

The exchangeable plastic cover protects aluminium and painted wheels from damage. The exchangeable plastic cover protects aluminium and painted wheels from damage.

**Bandenlichter**

Met verwisselbare kunststof beschermkap. De verwisselbare kunststof kap beschermt aluminium en gelakte velgen tegen beschadigingen.

**Démonte-pneus**

Avec gaine plastique amovible. La gaine en plastique amovible protège les jantes alu et en tôle.

**Desmontable**

ACon regla de plástico intercambiable. La regla de plástico protege llantas de aluminio o pintadas de raspaduras.



Befestigungsschrauben sind nicht im Lieferumfang enthalten.  
Fixing screws do not belong to scope of supply.

Bestell-No./Order-No.	Art. No.	CLD mm	g	g	€
<b>50815003880</b>	5081500	380	415	1	<b>36,50</b>
<b>50815005080</b>	5081500	500	775	1	<b>54,20</b>

**5081501**

**Ersatzschiene für Montiereisen**

Spare cover for tyre lever

Beschermkappen voor bandenlichters

Gaine plastique de rechange pour démonte-pneus

Regla de recambio para desmontable



Bestell-No./Order-No.	Art. No.	CLD mm	g	g	€
<b>50815013800</b>	5081501	380	55	1	<b>16,95</b>
<b>50815015000</b>	5081501	500	105	1	<b>19,10</b>

50815770900 / 50815771200

Präzises und sicheres Arbeiten: Die Form der geschmiedeten Enden garantiert hohe Festigkeit und Hebelwirkung, vor allem geeignet für enge Spalten und Bauräume. Besonders geeignet für Demontage, Abriss, Beton-, Straßen- und Schienenbau – für maximale Hebelkräfte und Belastungen.

For ultra-heavy-duty applications: The shape of the forged tails guarantees high strength and leverage, especially suitable for use in narrow gaps and tight spaces. Particularly suitable for dismantling and demolition work and in concrete, road and railway construction. Suitable for maximum leverage and strain.

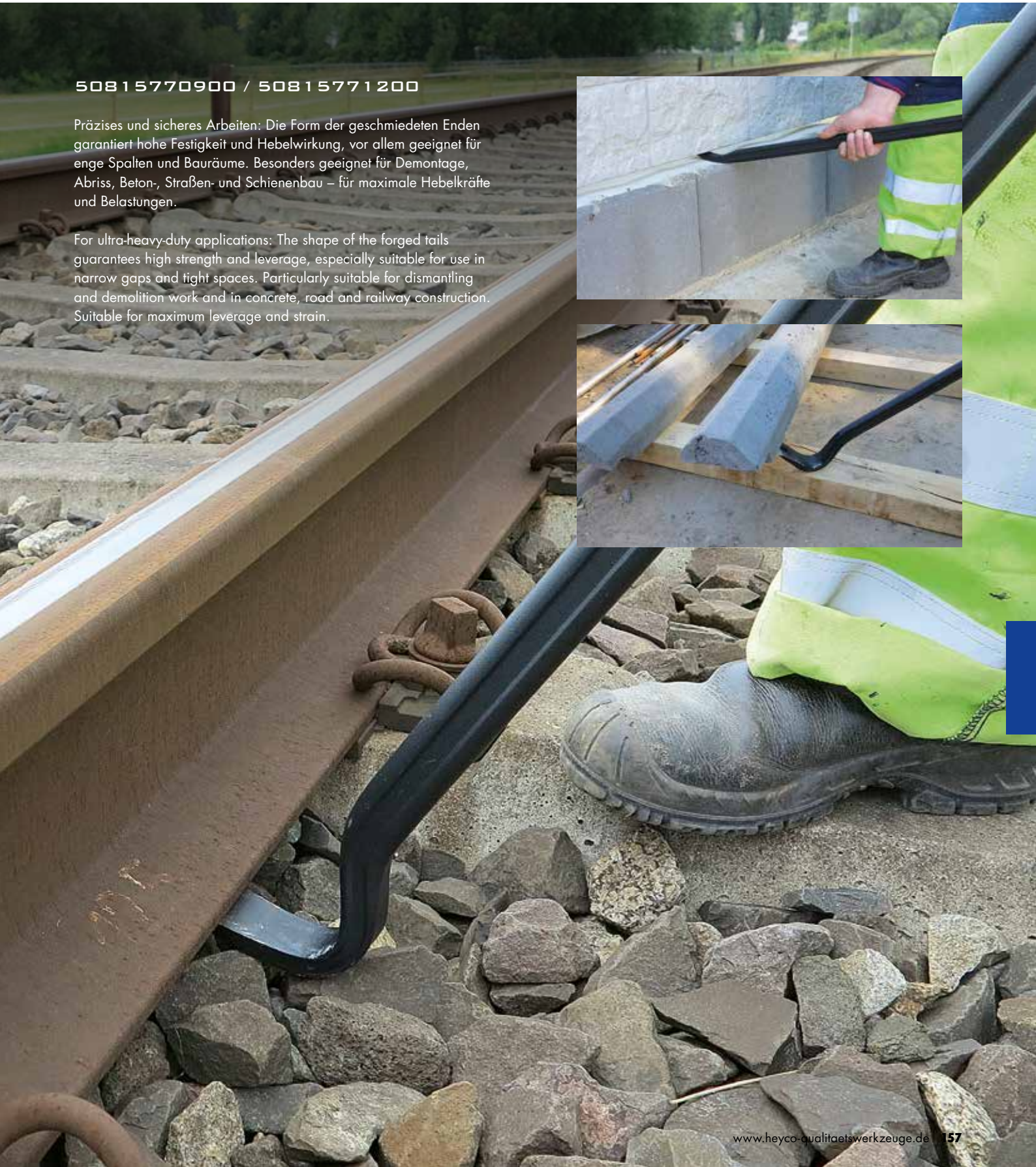





**508077-646**

77-tlg./pcs./dlg./pcs./pzs.

**Sanitär Werkzeugkasten mit 6 Modulen**

Sanitary tool box with 6 modules

Gereedschapskist met 6 modules

Caisse à outils de plombier avec 6 modules

Caja herramientas para fontanería con 6 módulos



Bestell-No./Order-No.	Art. No.	Maße - Dimensions			€
<b>50807764600</b>	508077-646	530 x 200 x 200 mm	16987	1	<b>820,35</b>

enthaltend/containing

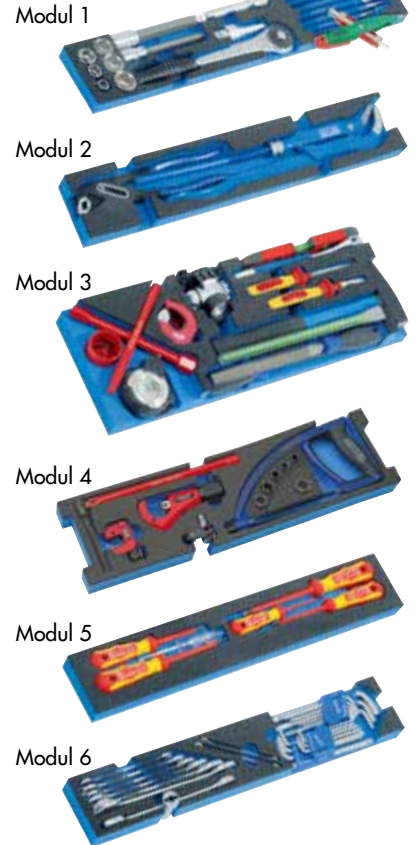

**508077-646**

**Werkzeugmodul 1**

Tool module 1

Gereedschapsmodul 1

Module avec outils 1

Módulo con herramientas 1



enthaltend/containing

- Werkzeugsatz mit Meißel, Körner, Splint- und Durchtreiber
- Cuttermesser Zinkguss, Klingebreite 18 mm, 5 Klingen
- Universalschlüssel Sanitär/Elektro
- Steckschlüssel Einsätze 6 Kt. 10/13/17/19/21/22 mm
- Stufenschlüssel 3/8", 7/16", 1/2", 5/8" (16mm), 13/16" (21mm)
- Verlängerung 1/2", 125 mm
- Verbindungsvierkant 1/2"
- Durchsteckknarre 1/2"
- Schraubendreher- Einsätze 1/2" 12/17, 138 mm Länge
- Chisel and pin punch set
- Cuttermessers zinc casting, blade range 18 mm, 5 blades
- Control cabinet key electric/sanitary
- Sockets hexagon 10/13/17/19/21/22 mm
- Combination stepped key 3/8", 7/16", 1/2", 5/8" (16mm), 13/16" (21mm)
- Extension bar 1/2", 125 mm
- Square coupler 1/2"
- Ratchet, push through 1/2"
- Screw driver sockets 1/2" 12/17, 138 mm length

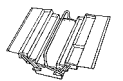

**508077-646**

**Werkzeugmodul 2**

Tool module 2

Gereedschapsmodul 2

Module avec outils 2

Módulo con herramientas 2

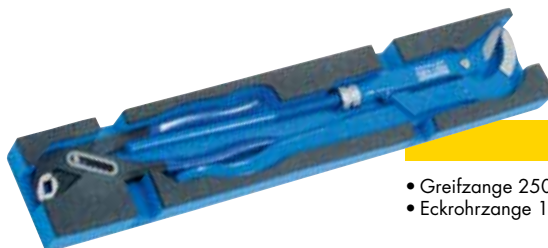

enthaltend/containing

- Greifzange 250 mm
- Eckrohrzange 1.1/2"
- Multigrip plier 250 mm
- Elbow pipe wrench 1.1/2"

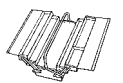



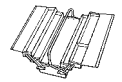

enthaltend/containing

### 508077-646

#### Werkzeugmodul 3

Tool module 3

Gereedschapsmodul 3

Module avec outils 3

Módulo con herramientas 3

- Wasserwaage 230 mm
- Verstellbarer Einmaulschlüssel 305 mm
- VDE-Kombinationszange 180 mm
- VDE-Radio- und Telefonzange 200 mm
- Schlosserhammer, Fiberglasstiel, 500 g
- Stirnlampe mit 9 LED's, Gurtband
- Steinmeißel 300 x 24 mm achtkant
- Rohrentgrater innen/ausßen Ø 42 mm
- Knarrenrohrabschneider Ø 22 mm
- Halbrundfeile 200 mm
- Rundfeile 200 mm
- Sanitär-Kreuzschlüssel 200x200 mm
- Profi-Bandmaß, Zinkguss, 5 m mit Gürtelclip
- Spirit level 230 mm
- Adjustable wrench 305 mm
- VDE combination plier 180 mm
- VDE radio-/telephone plier, 200 mm
- Engineer's hammer, fibreglass handle, 500 g
- LED headlamp with 9 LED's
- Stone chisel 300 x 24 mm octagonal
- Tube trimming tool inside/outside Ø 42 mm
- Ratchet tube cutter Ø 22 mm
- Engineer files, half-round 200 mm
- Engineer files, round 200 mm
- Sanitary cross wrench 200x200 mm
- Profi measuring tape, zinc, 5 m



enthaltend/containing

### 508077-646

#### Werkzeugmodul 4

Tool module 4

Gereedschapsmodul 4

Module avec outils 4

Módulo con herramientas 4

- Standhahnmutternschlüssel mit 6 Einsätzen 9/10/11/14/15/17 mm
- Mini-Rohrabschneider 3-25 mm
- Teleskop-Rohrabschneider 3-32 mm
- Mini-Metallbügelsäge 150 mm Blattlänge
- Basin wrench with 6 sockets 9/10/11/14/15/17 mm
- Mini tube cutter 3-25 mm
- Telescopic tube cutter 3-32 mm length of blade 150 mm
- Mini hacksaw

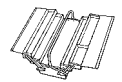

enthaltend/containing

### 508077-646

#### Werkzeugmodul 5

Tool module 5

Gereedschapsmodul 5

Module avec outils 5

Módulo con herramientas 5

- VDE Kreuz Schlitzschraubendreher PH1/PH2 für PHILLIPS-recess Schrauben
- VDE Elektriker Schraubendreher für Schlitzschrauben 75x2,5/100x4/125x5,5 mm
- Spannungsprüfer 150-250 V
- VDE cross slot screwdriver PH1/PH2 "PHILLIPS-recess"
- VDE electricians screwdriver for plain slot screws 75x2,5/100x4/125x5,5 mm
- Voltage tester 150-250 V

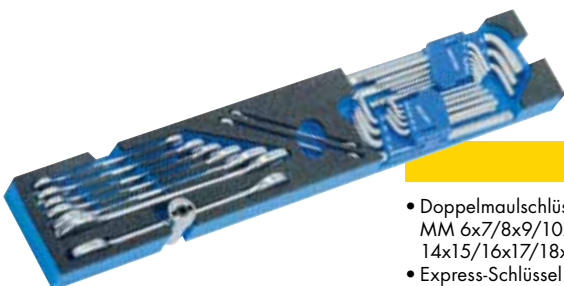

enthaltend/containing

### 508077-646

#### Werkzeugmodul 6

Tool module 6

Gereedschapsmodul 6

Module avec outils 6

Módulo con herramientas 6

- Doppelmaulschlüssel MM 6x7/8x9/10x11/12x13/14x15/16x17/18x19/20x22
- Express-Schlüssel MM 17x19
- Kugelkopf-Winkelschraubendreher, 9-tlg. 1,5-10 mm
- TORX-Winkelschraubendreher-satz, 9-tlg. T10-T50
- Double ended open jaw wrench MM 6x7/8x9/10x11/12x13/14x15/16x17/18x19/20x22
- Sanitary wrench MM 17x19
- Set of ball head hexagonal wrenches 9 pcs. 1,5-10 mm
- Set of L-sharpened TORX-wrenches 9 pcs. T10-T50



508200-646/-771/-772

Einfache Klickverbindung. Modularer Innenraum. Einzigartiges Mobilitätssystem. Beliebig erweiterbar. Crashesicherer Transport. Aus schlag- und stoßfestem ABS-Kunststoff. Ergonomisch geformten Griffe, zusätzliche seitliche Griffschalen sowie praktische Schlaufen garantieren ein flexibles und komfortables Handling. Der Deckel ist bis 100 kg belastbar, spritzwassergeschützt.

Robust click mechanism. Modular interior. Expandable as desired. Unique mobility system. Crash Safe transport. Made of impact and shock resistant ABS plastic. Ergonomically shaped handles and additional side grips for flexible and convenient handling. The lid can hold a load of up to 100 kg, spray-water protected.



## 508200-646

80-tlg./pcs./-dlg./pces./pzs.

### Sanitär-Werkzeugsortiment

In 2 L-BOXX®-Koffern:

A: Modul 1+2 mit 36 Werkzeugen

B: Modul 3+4 mit 44 Werkzeugen

Beladungskapazität pro Box bis zu 25 kg.

Transport der Boxen im Verbund bis 40 kg.

### Sanitary tool set

In 2 L-BOXX® boxes:

A: Modules 1+2 with 36 tools

B: Modules 3+4 with 44 tools

Loading capacity of up to 25 kg.

Transported in bundles up to 40 kg.

### Sanitair gereedschapset

In 2 L-BOXX® kisten:

A: Modules 1+2 met 36 stuks gereedschap

B: Modules 3+4 met 44 stuks gereedschap

Koffer belastbaar tot 25 kg. Bij gekoppelde koffers belastbaar tot 40 kg.

### Assortiment d'outils de plombier

En 2 L-BOXX® coffrets:

A: Module 1+2 avec 36 outils

B: Module 3+4 avec 44 outils

Capacité de chargement par boîte

jusqu'à 25 kg. Transport des boîtes en

combinaison jusqu'à 40 kg.

### Conjunto de herramientas sanitario

En 2 L-BOXX® maletas:

A: Módulos 1+2 con 36 herramientas

B: Módulos 3+4 con 44 herramientas

Capacidad de carga por conjunto hasta

25 kgs. Transporte de las cajas en

conjunto hasta 40 kgs.



Bestell-No./Order-No.	Art. No.	Maße · Dimensions	Module · Modules			€
<b>50820064600</b>	508200-646	442 x 357 x 151 mm	50807740100 50807740200 50807740300 50807740400	16780	1	<b>1.042,60</b>

### 508200-771

36-tlg./pcs./-dlg./pces./pzs.

#### Sanitär-Werkzeugsortiment

L-BOXX® Modul 1+2  
mit 36 Werkzeugen

Sanitary tool set  
L-BOXX® Modules 1+2  
with 36 tools

Sanitair gereedschapset  
L-BOXX® Modules 1+2  
met 36 stuks gereedschap

Assortiment d'outils sanitaire  
L-BOXX® Module 1+2 avec 36 outils

Conjunto de herramientas  
sanitario

L-BOXX® Módulos 1+2  
con 36 herramientas



Beladungskapazität pro Box bis zu 25 kg.  
Transport der Boxen im Verbund bis 40 kg.  
Loading capacity of up to 25 kg.  
Transported in bundles up to 40 kg.

Bestell-No./Order-No.	Art. No.	Maße · Dimensions	Module · Modules			€
<b>50820077100</b>	508200-771	442 x 357 x 151 mm	50807740100 50807740200	8030	1	<b>587,80</b>

### 508077-401

26-tlg./pcs./-dlg./pces./pzs.

#### Sanitär-Werkzeugsortiment für L-BOXX®

Sanitary tool set for L-BOXX®  
Sanitair gereedschapset voor L-BOXX®

Assortiment d'outils sanitaire pour L-BOXX®

Conjunto de herramientas sanitario para L-BOXX®



#### enthaltend/containing

	260 mm
	MM 17 x 19
	125 mm
	MM 12/17
	MM 10/13/17/19/21/22
	3/8", 7/16", 1/2", 5/8" (16mm), 13/16" (21mm)
	75 mm  Ø 42 mm
	Ø 3 - 25 mm
	Ø 3 - 25 mm
	MM 10/12/17/22
	Ø 10 - 32 mm
	1/4"

Bestell-No./Order-No.	Art. No.	Maße · Dimensions			€
<b>50807740100</b>	508077-401	405 x 310 x 60 mm	4140	1	<b>306,70</b>

### 5008077-402

10-tlg./pcs./-dlg./pces./pzs.

#### Sanitär-Werkzeugsortiment für L-BOXX®

Sanitary tool set for L-BOXX®  
Sanitair gereedschapset voor L-BOXX®

Assortiment d'outils sanitaire pour L-BOXX®

Conjunto de herramientas sanitario para L-BOXX®



#### enthaltend/containing

	180 mm
	200 mm
	✳ PZ 1 / 2
	MM 0,4 x 2,5 x 75 / 0,8 x 4,0 x 100 / 1,0 x 5,5 x 125
	150 - 250 V
	200 mm
	LED

Bestell-No./Order-No.	Art. No.	Maße · Dimensions			€
<b>50807740200</b>	5008077-402	405 x 310 x 40 mm	1610	1	<b>165,60</b>

### 508200-772

44-tlg./pcs./-dlg./pces./pzs.

#### Sanitär-Werkzeugsortiment

L-BOXX® Modul 3+4  
mit 44 Werkzeugen

Sanitary tool set  
L-BOXX® Modules 3+4  
with 44 tools

Sanitair gereedschapset  
L-BOXX® Modules 3+4  
met 44 stuks gereedschap

Assortiment d'outils sanitaire  
L-BOXX® Module 3+4  
avec 44 outils

Conjunto de herramientas  
sanitario  
L-BOXX® Módulos 3+4  
con 44 herramientas



Beladungskapazität pro Box bis zu 25 kg.  
Transport der Boxen im Verbund bis 40 kg.  
Loading capacity of up to 25 kg.  
Transported in bundles up to 40 kg.

Bestell-No./Order-No.	Art. No.	Maße · Dimensions	Module · Modules			€
<b>50820077200</b>	508200-772	442 x 357 x 151 mm	50807740300 50807740400	8770	1	<b>454,85</b>

### 508077-403

9-tlg./pcs./-dlg./pces./pzs.

#### Sanitär-Werkzeugsortiment für L-BOXX®

Sanitary tool set for L-BOXX®  
Sanitair gereedschapset voor L-BOXX®

Assortiment d'outils sanitaire pour L-BOXX®

Conjunto de herramientas sanitario para L-BOXX®



enthaltend/containing	
	3 m
	Gr. 18 mm
	320 mm
	150 mm
	500 g
	24 x 300 mm, 8-kt.
	200 mm

Bestell-No./Order-No.	Art. No.	Maße · Dimensions			€
<b>50807740300</b>	508077-403	405 x 310 x 40 mm	2830	1	<b>169,15</b>

### 508077-404

35-tlg./pcs./-dlg./pces./pzs.

#### Sanitär-Werkzeugsortiment für L-BOXX®

Sanitary tool set for L-BOXX®  
Sanitair gereedschapset voor L-BOXX®

Assortiment d'outils sanitaire pour L-BOXX®

Conjunto de herramientas sanitario para L-BOXX®



enthaltend/containing	
	Ø 3 x 120 mm
	Ø 5 x 150 mm
	Ø 3 x 120 mm
	5 x 130 mm
	12 x 130 mm / 14 x 150 mm
	MM 6 x 7 / 8 x 9 / 10 x 11 / 12 x 13 / 14 x 15 / 16 x 17 / 18 x 19 / 20 x 22
	MM 0 - 30
	250 mm
	MM 1,5/2/2,5/3/4/ 5/6/8/10
	TX 10/15/20/25/27/ 30/40/45/50
	230 mm

Bestell-No./Order-No.	Art. No.	Maße · Dimensions			€
<b>50807740400</b>	508077-404	405 x 310 x 55 mm	3320	1	<b>170,25</b>

## 5081791-0

### Compact

#### Profi-Kartuschenpistole

Kompakte Bauform durch innovative innenliegende Betätigungsmechanik. Gleichbleibend kompakte Abmessung, unabhängig vom verbrauchten Inhalt. Mit Verbrauchsanzeige. Nachlaufstop bei Nichtbetätigung.

#### Profi caulking gun

Compact design through innovative internal actuating mechanism. Consistently compact dimension, regardless of the content consumed. With consumption display. Overrun protection in case of non-operation.

#### Professioneel kitpistool

Compacte model, dankzij innovatief, inwendig mechanisme. Gelijkblijvende, compacte afmeting, onafhankelijk van het verbruikte materiaal. Met verbruiks-aanduiding. Met automatische stop.

#### Pistolet à cartouches professionnel

Design compact avec mécanisme de fonctionnement intérieur innovant. Dimension compacte constante, quelle que soit le matériel consommé. Avec jauge de consommation. Frein spécial en cas de non activité.

#### Pistola de cartuchos profesional

Diseño compacto gracias su innovadora mecánica de accionamiento. Dimensión uniformemente compacta independientemente del material consumido. Con indicación del consumo. Bloqueo de puesta en marcha involuntaria.



Nur geeignet für leicht pressbare Medien, wie Silikone und Acryle. Nicht geeignet für zähe Medien, wie Kleber! Alternative: Kartuschenpistole Multipower verwenden.

Only suitable for easily compressible media like silicone and acrylic. Unsuitable for viscous media like glue. Alternative: Caulking Gun Multipower.



Bestell-No./Order-No.	Art. No.	Maße · Dimensions			€
<b>50817910000</b>	5081791-0	340 x 205 x 65 mm	720	1	<b>51,85</b>

## 5081791-1

### Multipower

#### Profi-Kartuschenpistole

Stabile, aufwendige Konstruktion für extreme Beanspruchung. Betätigung aus hochwertigem Aluminium-Druckguss. Ermüdungsfreies Verarbeiten von sämtlichen Medien durch kraftvolle Hebelübersetzung.

#### Profi caulking gun

Stable, sophisticated design for heavy duty applications. Actuation mechanism made of high-quality aluminium die-cast. Fatigue-proof processing of any material through powerful leverage.

#### Professioneel kitpistool

Stabiele, solide constructie voor extreme belastingen. Hefboommechanisme uit hoogwaardig drukkiet aluminium. Moeiteloos verwerken van alle kitsoorten dankzij de sterke overbrenging.

#### Pistolet à cartouches professionnel

Construction stable pour utilisation dans des conditions extrêmes. Fonctionnement en fonte d'aluminium de haute qualité. Utilisation simple sans effort grâce au levier puissant.

#### Pistola de cartuchos profesional

Diseño robusto para exigencias extremas. Pousoir en fonte d'aluminium. Procesamiento sin fatiga de toda clase de medios gracias a la transmisión por palanca.



Bestell-No./Order-No.	Art. No.	Maße · Dimensions			€
<b>50817910100</b>	5081791-1	360 x 225 x 65 mm	800	1	<b>41,40</b>

## 5081791-2

### Multipower Universal

#### Profi-Kartuschenpistole

- Vollummantelte Kartuschenpistole mit Aluminium Gehäuse aus Strangpressprofil
- Betätigung aus hochwertigem Aluminium-Druckguss
- Universalverarbeitung von Kartuschen und Beuteln
- Stabile, aufwendige Konstruktion für extreme Beanspruchung
- Glasfaserverstärkte Schraubkappen

#### Profi caulking gun

- Fully coated caulking gun with body made of extruded aluminium
- Actuation mechanism made of high-quality aluminium die-cast
- Universal processing of cartridges and bags
- Stable, sophisticated design for heavy duty applications
- Glassfibre reinforced screw caps

#### Professioneel kitpistool

- Gesloten kitpistool met hoogwaardige, aluminium behuizing
- Hefboommechanisme uit hoogwaardig drukgiet aluminium
- Voor verwerking van kokers en worsten
- Stabiele, solide constructie voor extreme belastingen

#### Pistolet pour silicone professionnel

- Pistolet pour silicone entièrement gainé avec boîtier en aluminium profilé extrudé
- Poussoir en fonte d'aluminium de haute qualité
- Utilisation universelle pour cartouche et sachets
- Construction stable pour utilisation dans des conditions extrêmes

#### Pistola de cartuchos profesional

- Pistola de cartuchos, carcasa de aluminio, perfil extruido
- Accionamiento de fundición inyectada de aluminio de gran calidad
- Procesamiento universal de cartuchos y bolsas
- Diseño robusto para exigencias extremas



310 ml



600 ml

- Für alle gängigen Kartuschen und Beutel mit einem Volumen von 310/600 ml geeignet
- Inklusive zwei Dosierspitzen
- Ermüdungsfreies Verarbeiten von sämtlichen Medien durch kraftvolle Hebelübersetzung
- For all common cartridges and bags with 310/600 ml content
- Including two tube nozzles
- Fatigue-proof processing of any material through powerful leverage

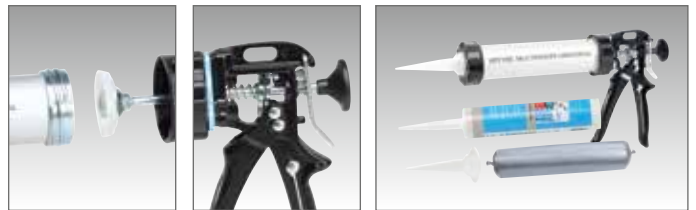

Bestell-No./Order-No.	Art. No.	Maße · Dimensions			€
<b>50817910200</b>	5081791-2	360 x 255 x 65 mm	1050	1	<b>47,90</b>
<b>50817910300</b>	5081791-3	490 x 255 x 65 mm	1400	1	<b>51,00</b>
<b>*50817912200</b>	5081791-22		62	2	<b>10,30</b>
<b>**50817912300</b>	5081791-23		300	2	<b>4,75</b>

\* Dosierspitzenset/Tube nozzles 10-tlg./pcs. für Profi-Kartuschenpistole/for professional caulking gun multipower universal 50817910200/XL: 50817910300  
 \*\* Ersatz Verschlusskappe/Black Cap 2-tlg./pcs. für Profi-Kartuschenpistole/for professional caulking gun multipower universal 50817910200/XL: 50817910300

## 5081791-90

### Fugenabzieher im Set

Zum Abziehen, Glätten und Formen von dauerelastischen Fugenmassen.

#### Handy screeding pads set

Set of handy screeding pads for skimming, flattening and shaping of permanent elastic joint seals.

#### Multifunctionele kitlepel

Kitlepel voor het gladstrijken en vormen van elastische kitten.

#### Set avec 4 palettes à lisser

Pour le retrait, le lissage et le façonnage de joints à élasticité permanente.

#### Herramienta para retocar juntas, en juego

Juego de herramientas para retocar, alisar y dar forma a juntas de masillas elásticas.

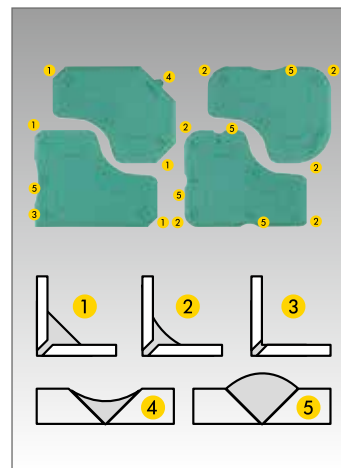

17 verschiedene Möglichkeiten.  
17 different alternatives.

Bestell-No./Order-No.	Art. No.	Maße · Dimensions			€
<b>50817919000</b>	5081791-90	225 x 160 x 10 mm	88	1	<b>19,35</b>

## 5081790-1

DIN 1283

### Handhebelfettpresse

L = lackiert, Kopf aus Zinkdruckguß, robuster Stahlrohrkörper zur Füllung mit Kartuschen, lösem Fett und durch Füllgeräte, mit 330 mm langem Gummipanzerschlauch und 170 mm langem abgewinkelten Druckrohr.

### Profi caulking gun

L = lacquered, head of zinc die-casting, robust steel body for loading with cartridges, bulk grease or by filler pumps, with high pressure rubber tube of 330 mm length and 170 mm long angled pressure pipe.

### Schaarvetspuit

L = gelakt, kop uit druk-gietzink, robuuste behuizing voor het vullen met vetpatronen, los vet d.m.v. hand en los vet d.m.v. vulapparaat. Met 330 mm lange, sterke rubber slang en 170 mm lange, gebogen drukpijp.

### Pompe à graisse à levier

Tête en zinc injecté, corps robuste en tôle à remplir de cartouches de graisse. Equipé d'un bec flexible en caoutchouc de 330 mm de long et tube de pression coudée de 170 mm de long. Idéal pour la lubrification mécanique des outils et machines.

### Prensa manual de engrasar

L = lacada. cabezal de fundición inyectada, cuerpo robusto de tubo de acero para carga con cartuchos, grasa a granel mediante aparatos de recarga, con tubo de goma de 330 mm y tupo de presión angular de 170 mm.

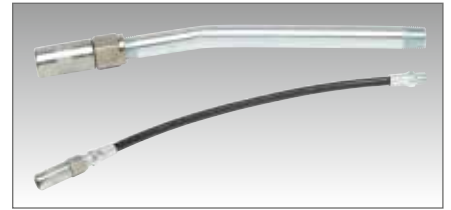

- Ideal zum Schmieren von mechanischen Werkzeugen und Maschinen, universell passend für alle gängigen Schmiernippel
- Ergonomischer Handgriff
- Ideal for lubricating mechanical tools and machines, universally suitable for all standard grease fitting
- Ergonomic handle

Bestell-No./Order-No.	lose/bulk	Inhalt/capacity ccm Kartuschen/cartridges	CLD mm "	g	1	€
<b>50817900120</b>	500	400	380/690	1100	1	<b>33,85</b>

## 5021450-1

## 5021450-2

### Saugheber

Aus hochwertigem Aludruckguss. Ansaugmechanik und Sicherheitsverriegelung. Ideal zum Transportieren, Ein- und Ausheben von PKW-Glas, Duschwannen, Fensterscheiben, Türen, Blechen, etc.

### Vacuum lifting pad

Made of high grade aluminium die cast. Suction mechanism with safety locking, ideal for lifting and transporting sheet metal, plastic sheets, glass panels, installation of windscreens, doors etc.. Movable suction cups particularly suitable for curved windscreens.

### Zuigheffer

Uit hoogwaardig spuitgiet aluminium. Aanzuigmechanisme en veiligheidsverrendeling. Ideaal voor transporteren, plaatsen en verwijderen van autoruiten, douchewanden, vensterglas, deuren, etc..

### Ventouses de portage

En aluminium de haute qualité. Système mécanique d'aspiration et blocage de sécurité idéal pour transporter, monter et démonter des pare-brises, portes, tôles etc..

### Ventosas

De aluminio de gran calidad. Mecanismo de vacío y cierre de seguridad, ideal para transportar, montar y desmontar cristales, parabrisas, puertas, chapas etc..



**80 kg**  
**5021450-1**  
 2 bewegliche Saugköpfe.  
 Traglast gesamt: 80 kg.  
 2 suction cups.  
 Capacity: 80 kg.

**120 kg**  
**5021450-2**  
 3 bewegliche Saugköpfe.  
 Traglast gesamt: 120 kg.  
 3 suction cups.  
 Capacity: 120 kg.



Bestell-No./Order-No.	Art. No.	Maße - Dimensions	g	g	1	€
<b>50214500100</b>	5021450-1	225 x 160 x 10 mm	80 kg	2200	1	<b>87,40</b>
<b>50214500200</b>	5021450-2	370 x 325 x 90 mm	120 kg	4500	1	<b>127,25</b>



## 5081640-25

### Mini-Rohrabschneider

Für enge Arbeitsbereiche, Schneidkapazität von Rohren Ø 3-25 mm, sichere Kraftübertragung durch Doppelführung.

#### Mini tube cutter

For hard of access workplaces, cutting capacity for tubes from 3 till 25 mm, power transmission secured thanks a double guiding.

#### Mini pijpsnijder

Voor kleine werkrumtes, snijcapaciteit van buizen Ø 3-25 mm, goede krachtoverbrenging dankzij dubbele geleiding.

#### Mini coupe-tube

Pour des travaux difficiles d'accès, capacité de coupe de tubes de 3 à 25 mm, transmission de force assurée par un double guidage.

#### Mini-cortatubos

Para trabajar en sitios limitados, Capacidad de corte para tubos de Ø 3 a 25 mm, Sugura aplicación de fuerza gracias a la guía doble.



Spezielle Bauform mit kleinem Arbeitsradius.  
Special construction with a reduced working range.

Bestell-No./Order-No.	Art. No.	Cl Ø mm	⌀	g	mm	€
<b>50816402500</b>	5081640-25	80	3-25	160	1	<b>14,70</b>
<b>*50816430100</b>	5081643-1	Stahl*	16	5	1	<b>9,05</b>
<b>*50816430200</b>	5081643-2	Kupfer*	16	5	1	<b>5,30</b>

\*Ersatz-Schneiderad · Replacement cuttingwheel  
\* Stahl/Kupfer · Steel/Copper

## 5081640-32

### Teleskop-Rohrabschneider

Für dünnwandige Rohre Ø 3-32 mm, max. Wanddicke bis 4 mm, sichere Kraftübertragung durch Teleskopführung.

#### Telescopic tube cutter

For thin wall tubes from 3 till 32 mm, wall thickness till 4 mm, power transmission secured through telescopic guiding.

#### Telescopische pijpsnijder

Voor dunwandige pijp Ø 3-32 mm, max. wanddikte tot 4 mm, goede krachtoverbrenging door telescoopgeleiding.

#### Coupe-tube télescopique

Pour tubes à paroi mince, diamètre de 3 à 32 mm, paroi ép. maxi jusqu' à 4 mm, transmission de force assurée par un guidage télescopique.

#### Cortatubos telescópico

Para tubos de pared delgada de Ø 3 a 32 mm, grosor máximo de pared 4 mm, avance de la cuchilla por sistema telescópico.



Schneiderad aus Spezialstahl für extrem lange Haltbarkeit, leichtes Verstellen des Arbeitsbereiches.  
High quality cutting wheel out of special steel for an outer long life, easy and quick fitting to the working areas.

Bestell-No./Order-No.	Art. No.	Cl Ø mm	⌀	g	mm	€
<b>50816403200</b>	5081640-32	135	3-32	400	1	<b>26,35</b>
<b>*50816430100</b>	5081643-1	Stahl*	16	5	1	<b>9,05</b>
<b>*50816430200</b>	5081643-2	Kupfer*	16	5	1	<b>5,30</b>

\* Stahl/Kupfer · Steel/Copper

## 5081643-15 / 5081643-22

### Knarrenrohrabschneider

Ideal für schwer zugängliche Stellen, kein Nachstellen erforderlich, da Eigenklemmung und Selbstnachstellung.

#### Ratchet tube cutter

Ideal for hard of access workplaces, no adjustment needed, automatic setting up and clamping.

#### Ratel pijpsnijder

Ideaal voor moeilijk bereikbare plaatsen, geen nastellen nodig, klemt en stelt automatisch bij.

#### Coupe-tubes à cliquet

Idéal pour les endroits difficiles d'accès, pas de réglage nécessaire.

#### Cortatubos de carraca

Para trabajar en sitios limitados, no necesita re-ajuste, debido a su acoplamiento y ajuste automáticos.



Schnelles Trennen von Rohren mit wenigen Umdrehungen.  
Quick cut of tubes with very few rotations.

Bestell-No./Order-No.	Art. No.	Cl Ø mm	⌀	g	mm	€
<b>50816431500</b>	5081643-15	65	15	245	1	<b>15,75</b>
<b>50816432200</b>	5081643-22	75	22	276	1	<b>18,95</b>
<b>*50816430300</b>	5081643-3	Kupfer*	16	5	1	<b>5,30</b>

\*Ersatz-Schneiderad · Replacement cuttingwheel  
\* Kupfer · Copper

## 5081640-42

### Rohrentgrater

**Außen/Innen.** Massives Zinkdruckgußwerkzeug, Entgratung von Rohren bis Ø 42 mm, gehärtete Spezialklingen.

### Tube trimming tool

**Outside/Inside.** Die-cast zinc, tube trimming till Ø 42 mm, special hardened sharpener.

### Pijpontbramer

**Buiten/Binnen.** Massief zinksputgietgereedschap, ontbramen van pijpen tot Ø 42 mm, geharde speciale messen.

### Ebavureur de tubes

**Extérieur/Intérieur.** Ebavureur de tubes de qualité en zinc moulé sous pression. Ebavurage des tubes jusqu'à 42mm, affûteur spécial trempé.

### Rebabador

**Exterior/Interior.** Rehabador de calidad, de fundición inyectada, rebabado de tubos de hasta Ø 42 mm, cuchillas especiales, templadas.

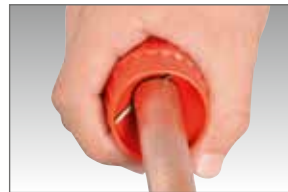

Einfache Handhabung.  
Easy handling.

außen, outside, extérieur, exterior innen, inside, intérieur, interior

Bestell-No./Order-No.	Art. No.	Ø	g	1	€
<b>50816404200</b>	5081640-42	42	245	1	<b>14,30</b>

## 5081646-42

### Kunststoff-Rohrabschneider

Zum Schneiden von PVC Kabelkanälen, Plastikrohren, Gummischläuchen, etc. Schneidekapazität bis Ø 42 mm mit Ratschenfunktion. Robuster Aluminiumkörper.

### PVC Pipe tube cutter

For effortless cutting of PVC cable channels, plastic pipes, rubber tubes, etc. Cutting capacity till Ø 42 mm with ratchet function. High quality aluminium body.

### PVC schaar

Voor het knippen van PVC kabelgoten, kunststof buizen, rubber slangen, etc. Snijscapaciteit tot Ø 42 mm. Met ratel-functie. Robuuste aluminium uitvoering.

### Coupe tube PVC

Pour couper les conduites de câbles en PVC et tuyaux en caoutchouc. Capacité de coupe jusqu'à 42mm de diamètre, à cliquet. Corps en aluminium solide.

### Cortatubos para tubos de plástico

Para cortar toda clase de tubos de PVC y goma. Capacidad de corte hasta 42 mm Ø con función de carraca. Cuerpo robusto de aluminio.



Bestell-No./Order-No.	Art. No.	Ø mm	Ø	g	1	€
<b>50816464200</b>	5081646-42	210	42	370	1	<b>42,25</b>

## 5081648

4-tlg./pcs./-dlg./pces./pzs.

### Drahtsäge Set

Bestehend aus 2 spiralverzahnten Säge-  
drähten, sowie 2 Zugringen.

### Wire saw set

Consisting of 2 spiral-toothed cutting  
wires and 2 pull rings.

### Draadzaagset

Bestaand uit 2 spiraalvertande zaagdra-  
den en twee grepen.

### Scie fil

Comprenant de 2 fils de coupe en spirale  
à dents et 2 anneaux de traction.

### Juego de sierras de alambre

Compuesto de 2 sierras de alambre con  
dentado espiral y 2 anillas de tiro.

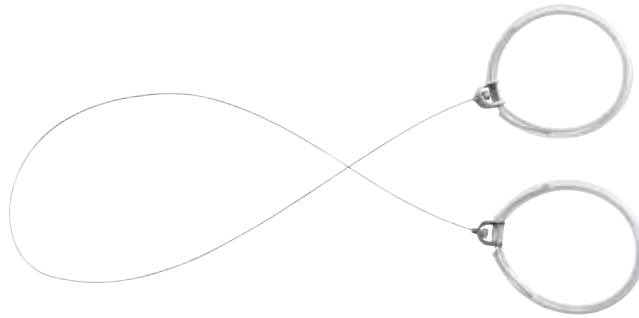

Zum Schneiden von ABS, PVC und CPVC  
Rohren in Ecken und an schwer zugäng-  
lichen Stellen. In Abhängigkeit des zu  
schneidenden Materials, mehrmaliger  
Einsatz möglich.

For cutting of ABS, PVC and CPVC tubes in  
corners and in hard to access workplaces.  
Depending on the material to be cut  
repeated use is possible.



Bestell-No./Order-No.	Art. No.	CLD mm	g	mm	€
<b>50816480000</b>	5081648	800	30	1	<b>14,70</b>
<b>*50816480200</b>	5081648-2	600	20	1	<b>7,95</b>

\* Ersatz-Sägedraht, 2-tlg. · Spare cutting wire, 2 pcs.

## 5081756-1

### 2 in 1 Kupferrohrbürste

Für Innen- und Außenreinigung von Kup-  
ferrohren. Ø 15 mm / Ø 22 mm.

### 2 in 1 Copper tube pouch

For inner- and outer cleaning of copper  
tubes. Ø 15 mm / Ø 22 mm.

### 2 en 1 pijpborstel

Voor in- en uitwendig reinigen van  
koperen pijp. Ø 15 mm / Ø 22 mm.

### Brosse à tube en cuivre 2-en-1

Pour nettoyage intérieur et extérieur des  
tuyaux en cuivre. Ø 15 mm / Ø 22 mm.

### 2 en 1 Cepillo para tubos de cobre

Para la limpieza interior y exterior de  
tubos de cobre. Ø 15 mm / Ø 22 mm.

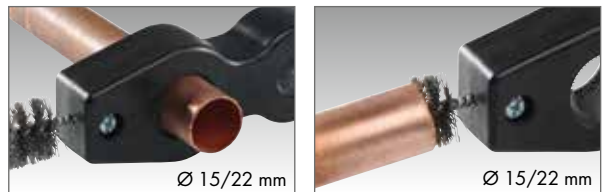

Bestell-No./Order-No.	Art. No.	CLD mm	Ø	g	mm	€
* <b>50817560100</b>	5081756-1	200	15 / 22 mm	100	1	<b>16,85</b>

\* Auslauf / Discontinued

## 50958

### Express-Schlüssel

Chrom-Vanadium, verchromt, Montage-  
schlüssel für Express- und Stockschrauben,  
Mittelstück mit Innengewinde für Stock-  
schrauben M 10.

### Sanitary wrench

Chrome-Vanadium, chromium plated,  
for bathroom fittings attachment (metric  
screws).

### Sanitair sleutel

Chroom-Vanadium, verchromd, montage  
sleutel voor sanitair schroeven M 10.

### Clé sanitaire

Chrome-vanadium, chromé, pour le mon-  
tage et démontage facile des lavabos.  
Partie Médiane avec filetage et bille  
intégrée pour tiges filetées M10.

### Llaves para tornillos tipo

### Express

Cromo Vanadio, cromadas, llaves para  
montar tornillos tipo Express y Stock,  
pieza central con rosa interior para tornillos  
Stock M 10.



Für Waschtischbefestigungen und Eckventilmontagen.  
For bathroom fittings attachment (metric screws).



Bestell-No./Order-No.	Art. No.	ØMM	CLD mm	g	mm	€
<b>50958171980</b>	50958	17 x 19	223	265	5	<b>25,25</b>

Chrom-Vanadium, verchromt  
 Chrome-Vanadium, chromium plated  
 Chromo-Vanadium, verchromd  
 Chrome-Vanadium, chromées  
 Cromo Vanadio, cromadas

### 50750-01

DIN 3122 C

2-tlg./pcs./-dlg./pces./pzs.

Durchsteckknarre  
 mit Verbindungsvierkant

Ratchet, with square coupler

Doorsteekratel

met verbindingsvierkant

Cliquet avec carré conducteur

Carraca pasante de

acoplamiento cuadrado



Bestell-No./Order-No.	Art. No.		CLD mm			€
<b>50750010080</b>	50750-01	1/2"	260	490	5	<b>32,75</b>

### 50750-01-1

DIN 3122 C

Durchsteckknarre  
 ohne Verbindungsvierkant

Ratchet, without square coupler

Doorsteekratel, zonder

verbindingsvierkant

Cliquet sans carré conducteur

Carraca, sin cuadradillo



Bestell-No./Order-No.	Art. No.	CLD mm			€
<b>50750010180</b>	50750-01-1	260	430	5	<b>27,75</b>

### 90050-16

Verbindungsvierkant

für 1/2" Verbindungen.

Square coupler

for 1/2" connections.

Verbindingsvierkant

voor 1/2" hulpstukken.



Carré conducteur

pour connexions 1/2".

Adaptador

para 1/2" conexions.



Bestell-No./Order-No.	Art. No.	CLD mm			€
<b>90050160083</b>	90050-16	37	45	10	<b>5,20</b>

### 90050-4

Stufenschlüssel

Für Ein- und Ausbau von Heizkörperventilnippeln, Rücklaufverschraubungen und kurzen Hahnverlängerungen.

Combination stepped key

For pin, hexagon and double hexagon drivers, for installing and removing radiation valves, run-back screws and short tap extensions.

Trapsleutel

Voor in- en uitdraaien van radiatorkop-pelingen, terugslagkleppen, en korte kraanverlengstukken.



Clé étagée

Pour le montage et démontage de vannes de radiateur, clapet anti-retour et rallonges courtes de robinets.

Llaves escalonadas

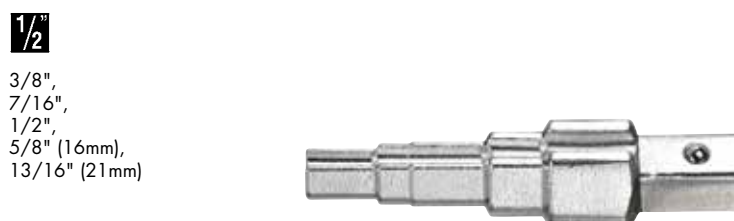
Llaves combinadas para montar y desmontar valvulas de radiador, racores de retorno y sxtensions de grifo cortos.



Bestell-No./Order-No.	Art. No.	CLD mm			€
<b>90050400080</b>	90050-4	90	120	1	<b>14,70</b>

Chrom-Vanadium, verchromt  
 Chrome-Vanadium, chromium plated  
 Chrom-Vanadium, verchromd  
 Chrome-Vanadium, chromées  
 Cromo Vanadio, cromadas

### 58103

Stufenschlüssel-Satz  
 In Kunststoffschraubverpackung.  
 Stepped wrench  
 and ratchet set  
 In screw cap plastic tube.

Trapsleutelset  
 In kunststof schroeffkoker.  
 Jeu cliquet et clé étagée  
 En étui plastique cylindrique.

Conjuntos de llaves  
 escalonadas con carraca  
 En tubo de plástico con tapa a rosca.



Bestell-No./Order-No.	Art. No.	CLD mm			€
<b>58103000100</b>	58103	290	610	1	<b>41,80</b>

### 98263-06

Spezial-Kardangeln  
 Beide Antriebsseiten mit Innenvierkant.

Universal joint, special  
 With two female squares.

Speciaal cardangewricht  
 Beide zijden met binnenvierkant 1/2".

Cardan universel spécial  
 Les deux côtés d'entraînement avec carré  
 intérieur.

Articulación universal especial  
 Ambos lados con cuadradillo hembra.



Bestell-No./Order-No.	Art. No.	CLD mm			€
* <b>98263060080</b>	98263-06	65	180	1	<b>20,65</b>

\* Auslauf / Discontinued

### 50780

11-tlg./pcs./dlg./pcs./pzs.

Sanitär-Garnitur  
 In Metallkasten.

Sanitary tool set  
 In metal case.

Sanitair gereedschapset  
 In metalen kist.

Jeu d'outils «sanitaire»  
 En coffret métallique.

Conjunto para fontaneros  
 En casa metálica.



enthaltend/containing	
	MM 10/13/17/19/21
	260 mm
	MM 17 x 19
	125 mm
	90 mm
	MM 6
	34 mm



Bestell-No./Order-No.	Art. No.	Maße · Dimensions			€
<b>50780809580</b>	50780	320 x 120 x 50 mm	2480	1	<b>121,75</b>



### 508494-016

Ölbrennerschlüssel  
 Oil burner key  
 Oliebrander sleutel  
 Clé mixte à douille pour  
 chaudière  
 Llave para quemador aceite



Bestell-No./Order-No.	Art. No.	MM	CLD mm	g		€
<b>50849401680</b>	508494-016	16	250	250	1	<b>16,85</b>

### 50889694400

6-tlg./pcs./-dlg./pces./pzs.

Rohrsteckschlüssel-Satz  
 verchromt, inklusive Drehstift  
 Double ended tubular socket  
 wrench set  
 chromium plated, with tommy bar  
 Pijpsleutelset  
 verchromd, met wringstaaf  
 Jeu de clés en tube  
 chromées, avec tige de serrage  
 Juego llave de tubo  
 cromado, incluye pasador

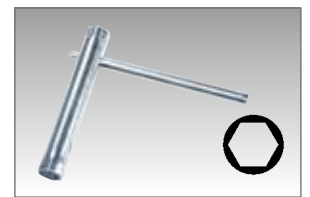

Bestell-No./Order-No.	MM	g		€
<b>50889694400</b>	8x9 / 10x11 / 12x13 / 14x15 / 16x17 mm	370	1	<b>7,90</b>

### 50896101360 50896111260

Rohrsteckschlüssel  
 Lange Ausführung.  
 Double ended tubular socket  
 wrenches  
 Long version.  
 Pijpsleutel  
 Lange uitvoering.  
 Clés en tube  
 Version longue.  
 Llaves de tubo  
 Versión larga.



Besonders geeignet zur Amaturenmontage an bedingt zugänglichen Arbeitsbereichen an Waschbecken, Spülen und Verschraubungen an Gewindestangen.  
 Particularly suitable for mounting fittings in difficult to access working areas.

Bestell-No./Order-No.	CLD mm	MM	g		€
<b>50896101360</b>	300	10/13	143	1	<b>12,45</b>
<b>50896111260</b>	300	11/12	143	1	<b>12,45</b>



## 90950

### Standhahnmutternschlüssel

Chrom-Vanadium, lackiert, gesenkgeschmiedet, sehr robust, schwenkbarer Quergriff, mit schwenkbarer, gefederter Klaue für Rechts- und Linksgang. Für sämtliche Verschraubungen und Standhähne geeignet.

#### Basin wrench

Chrome-Vanadium, lacquered, with pivoted hook for right-hand or left-hand operations.

#### Kraanmoersleutel

Chroom-Vanadium, gelakt, met zwekbare greep voor links- en rechtshandig gebruik.

#### Clé à lavabo

Chrome vanadium, laquée, avec manche et mâchoire articulée pour un maniement aisé. Fonctionnement droite/gauche.

#### Llaves para tuerca de lavabo

Cromo Vanadio, barnizado, forjadas, muy robustas, manivela articulada, con garra articulada y con muelle, para montar y desmontar.



Bestell-No./Order-No.	Art. No.	mm	Ø	AF	CLD mm	g	mm	€
<b>90950103220</b>	90950	10 - 32		3/8" - 1.1/4"	240	520	2	<b>41,80</b>

## 90955

### Sanitärkreuzschlüssel

Lackiert, Spezialschlüssel für die Sanitärtechnik, zum Ein- und Ausbau von Hahnverlängerungen, Heizkörperventile, sowie Rücklaufverschraubungen 3/8" / 1/2" / 3/4" / 1" und Express Schrauben M 8 / M 10 / M 12.

#### Sanitary cross wrench

Lacquered, special wrench for sanitary installation, for valve extensions, installation and removal of heating valves and tank connectors 3/8" / 1/2" / 3/4" / 1". Boits: M 8 / M 10 / M 12.

#### Sanitair kruissleutel

Gelakt, speciale sleutel voor de installatietechniek, voor in- en uitdraaien van kraanverengstukken 3/8" / 1/2" / 3/4" / 1" en montagesbouten M 8 / M 10 / M 12.

#### Clé sanitaire en croix

Laqué, pour le montage et le démontage: de robinets 3/8" / 1/2" / 3/4" / 1", de vis d'arrêt de fixation de lavabo M 8 / M 10 / M 12.

#### Llaves en cruz para fontanero

Barnizado, llaves especiales para fontanería, pintadas en epoxi, para montar y desmontar extensiones de grifos 3/8" / 1/2" / 3/4" / 1", para tornillos tipo Express M 8 / M 10 / M 12.



Bestell-No./Order-No.	Art. No.	MM	CLD mm	g	mm	€
<b>90955020020</b>	90955	10 / 12 / 17 / 22	200 x 200	520	5	<b>29,55</b>







### 5081731

DIN EN 166 F

#### Schutzbrille

Protective glasses

Veiligheidsbril

Lunettes de protection

Lafas protectoras



Bestell-No./Order-No.	Art. No.			€
<b>50817310000</b>	5081731	70	1	<b>9,00</b>

### 5081732

CE/EN 352-1 2003

#### Kapsel-Gehörschutz

Hoher Dämmwert SNR 30 dB. Einfaches Anpassen an jede Kopfform durch vielfältige Verstellmöglichkeiten. Kompakt zusammenfaltbar für einfachen Transport.

Foldable ear muff

High attenuation SNR value 30 dB. Easy adaption to any head shape by versatile adjustability. Compactly foldable for easy transport.

Gehoorsbeschermer

Hoge demping SNR 30 dB. Eenvoudig in grootte aanpasbaar dankzij de vele verstelmogelijkheden. Compact opvouwbaar voor eenvoudig transport.

Protecteur auditif

Valeur d'isolation élevée SNR 30 dB. Facile à adapter à n'importe quelle forme de tête grâce à un ajustement multiple. Se plie de manière compacte pour un transport facile.

Cascos de protección del oído

Alto valor aislante SNR 30db. Fácil adaptación a cualquier forma de cabeza, gracias a múltiples posibilidades de ajuste. Plegable para facilitar su transporte.

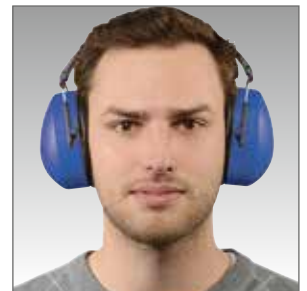

Kunstleder Kopfband. Kunstleder gepolsterte Ohrmuschel.  
PVC headband. Ear cups with soft PVC cushions.

Bestell-No./Order-No.	Art. No.			€
<b>50817320000</b>	5081732	240	1	<b>12,60</b>

### 5081733

CE/EN 388-4131

#### Arbeitshandschuhe

Aus atmungsaktivem, strapazierfähigem Nylonmaterial. Handinnenflächen Nitril Schaum beschichtet. Hervorragende Beständigkeit gegen Öle und Fette.

Protective gloves

Made of breathable, sturdy nylon material. Palms coated with nitrile foam. Excellent resistance to oil and grease.

Werkhandschoenen

Van ademend, duurzaam nylon. Voorzien van Nitril coating. Uitstekend bestand tegen oliën en vetten.

Gants de travail

En nylon durable et respirant. Paume enduite de nitrile. Excellente résistance contre les matières grasses.

Guantes de trabajo

De nylon, transpirables y resistentes. Superficies en la palma, recubiertas de espuma de nitrilo. Resistente a aceites y grasas.

EN 388



4131



Ausgezeichnete Passform. Sehr gutes Tastempfinden. Hohe Griffsicherheit bei Feuchtigkeit. Excellent fit. Very good sense of touch. Providing good grip under humid working conditions.



Bestell-No./Order-No.	Art. No.	Größe - Size			€
<b>50817330800</b>	50817-33-08	8"	30	12	<b>5,25</b>
<b>50817330900</b>	50817-33-09	9"	30	12	<b>5,25</b>

## 5081611-1

### Japansäge

Extra dünnes Sägeblatt - besonders geeignet für schwer zugängliche Stellen. Hochwertige SK5-Stahl Sägeblätter, Zähne induktiv gehärtet.

### Japanese Saw

Extra thin blade - best suited for areas difficult to access. High grade SK5 steel blades, induction hardened teeth.

### Japanse zaag

Extra dun zaagblad - uitermate geschikt voor moeilijk bereikbare plaatsen. Hoogwaardig SK5-stal zaagblad, tanden inductief gehard.

### Scie japonaise

Lame extra fine - particulièrement appropriée pour les zones difficiles d'accès. Lames en acier SK5 - dents trempées par induction.

### Sierra japonesa

Hoja extra delgada, especialmente indicada para trabajar en sitios de difícil acceso. Hojas en acero SK5 alta aleación, dientes templados por inducción.

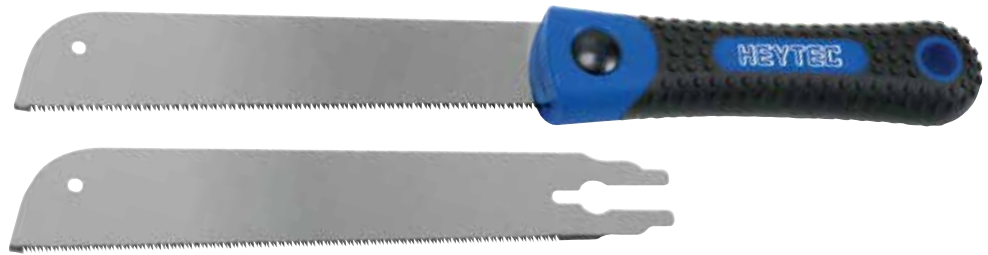

Inkl. 2 Sägeblätter (fein/mittel). Austausch des Sägeblattes durch Knopfdruck. Lieferung in Blisterverpackung.  
Incl. 2 saw blades (fine/medium). Replacing the blade by pressing a button. Supplied in blister packing.

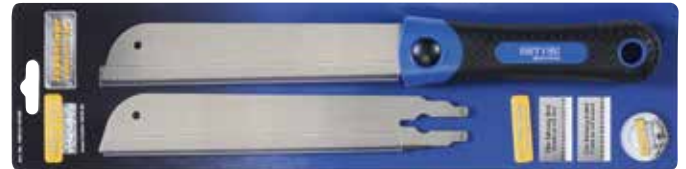

Sauberer, glatter Schnitt durch feine Zahnung  
Clean and smooth cut appearance by fine toothting

Schnittbild mit herkömmlicher Säge  
Cut appearance of a conventional saw

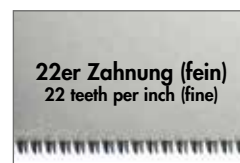

22er Zahnung (fein)  
22 teeth per inch (fine)

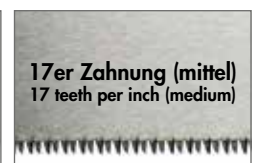

17er Zahnung (mittel)  
17 teeth per inch (medium)



## 5081613

3-tlg./pcs./dlg./pces./pzs.

### Multifunktion Handsäge

Griff in zwei Winkel einstellbar, einfache Handhabung. Hochwertiger 2-K Kunststoffhandgriff. Der Griff nimmt sowohl Säbelsägeblätter mit 1/2" Standardaufnahme als auch 1/4" Standardbits auf, sicherer Halt und einfacher Austausch. Zwei Winkeleinstellung möglich, der Griff rastet automatisch in die Arbeitsposition ein.

### Multifunction handsaw

Two angles adjustable, easy handling. High-quality 2-K plastic handle. Handle accepts 1/2" reciprocating saw blades and standard 1/4" hexagon bits, safe hold and easy replacement of the saw blade. Two angle settings, handle automatically locks into position.

### Multifuncionele handzaag

Greep in 2 standen verstelbaar, eenvoudig te gebruiken. Hoogwaardige 2-comp. kunststof greep. Greep is geschikt voor 1/2" reciprozagen en 1/4" bits, stevige vergrendeling en eenvoudig verwisselbaar. Twee instelbare hoeken mogelijk, de greep blokkeert automatisch in positie.

### Scie à main multifonction

Poignée réglable en deux angles, manipulation facile. Manche en plastique, 2 composants, haute qualité. Utilisable avec les lames de scies sabres standard 1/2" ou comme porte-embouts 1/4". Remplacement rapide des outils. Verrouillage automatique dans la position de travail.

### Sierra de mano multifuncional

Mango ajustable en 2 ángulos, manejo sencillo. Mango de plástico 2K de calidad. El mango vale para aceptar hojas de sierra con conexión estandar 1/2", así como de 1/4". Bist estandar de sujeción segura y fácil cambio. Posibilidad de 2 ángulos, el mango se posiciona automáticamente.

Bestell.-No./Order-No.	Art. No.	CLD mm	g	pcs	€
50816110100	5081611-1	320	180	1	20,00



Je ein Sägeblatt für Metall 6"X24T / Holz 6"X10T, Zähne induktiv gehärtet. Besonders geeignet für schwer zugängliche Stellen. Lieferung in Blisterverpackung.  
One saw blade for metal 6"X24T / one for wood 6"X10T, induction hardened teeth. Best suited for areas difficult to access. Supplied in blister packing.

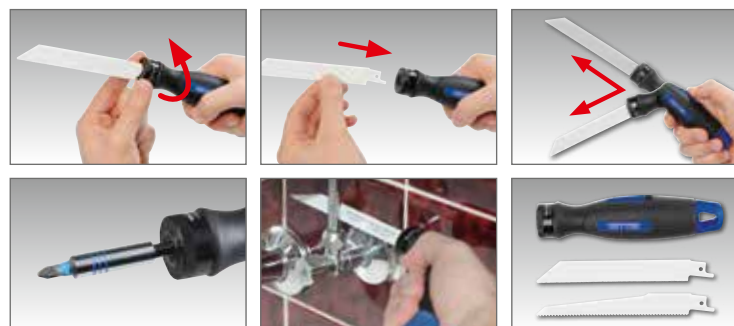

Bestell.-No./Order-No.	Art. No.	CLD mm	g	pcs	€
50816130000	5081613	280	250	5	19,60

Geeignet für HEYTEC Multifunktion Handsäge  
 Suitable for HEYTEC multifunction hand saw  
 Geschikt voor HEYTEC multifunctionele handzaag  
 Convient pour HEYTEC scie à main multifonction  
 Adecuadas para sierra multifunción  
 Art. No. 5081613

### 5081613-10

5-tlg./pcs./-dlg./pces./pzs.

#### Sägeblätter-Set für Holz

Sägeblatt für Holz 6"X10T.

Set of saw blades for wood

Saw blade for wood 6"X10T.

Set zaagbladen voor hout

Zaagblad voor hout 6"X10T.

Jeu de lames de scies à bois

Lame de scie pour bois 6"X10T.

Juego de hojas de sierra para madera

Hoja de sierra para madera 6"X10T.



Bestell-No./Order-No.	Art. No.	CLD mm			€
<b>50816131000</b>	5081613-10	150	110	10	<b>15,35</b>



### 5081613-20

5-tlg./pcs./-dlg./pces./pzs.

#### Sägeblätter-Set für Metall

Sägeblatt für Metall 6"X10T.

Set of saw blades for metal

Saw blade for metal 6"X10T.

Set zaagbladen voor metall

Zaagblad voor metall 6"X10T.

Jeu de lames de scie à métaux

Lame de scie pour métal 6"X10T.

Juego de hojas de sierra para metal

Hoja de sierra para metal 6"X10T.

Hochwertige Sägeblätter, Zähne induktiv gehärtet.  
 Sicherer Halt und einfacher Austausch des Sägeblattes.



Bestell-No./Order-No.	Art. No.	CLD mm			€
<b>50816132000</b>	5081613-20	150	110	10	<b>15,35</b>

### 5081613-30

#### Handgriff für Multifunktion Handsäge

Griff in zwei Winkel einstellbar, einfache Handhabung. Hochwertiger 2-K Kunststoffhandgriff.

Handle for multifunction handsaw

Two angles adjustable, easy handling. High-quality 2-K plastic handle.

Greep voor multifunctionele handzaag

Greep in 2 standen verstelbaar, eenvoudig te gebruiken. Hoogwaardige 2-comp. kunststof greep.

Poignée pour scie à main multifonction

Deux angles réglables, manipulation facile. Manche en plastique 2-C de haute qualité.

Mango para sierra de mano multifuncional

Mango ajustable en 2 ángulos, manejo sencillo. Mango de plástico 2K de gran calidad.



Besonders geeignet für schwer zugängliche Stellen.  
 Der Griff nimmt sowohl Säbelsägeblätter mit 1/2" Standard-aufnahme als auch 1/4" Standardbits auf.  
 Extra thin blade - best suited for areas difficult to access.  
 Handle accepts 1/2" reciprocating saw blades and standard 1/4" hexagon bits.



Bestell-No./Order-No.	Art. No.	CLD mm			€
<b>50816133000</b>	5081613-30	160	200	5	<b>13,25</b>

## 50816152400

### Dämmstoffmesser

Spezial-Klinge mit Glattschliff. Zum sauberen Schneiden von Styropor, EVA, Glasfaser, Schaum- und Dämmstoffen,

Knife for insulating material  
Special blade with straight edge, for clean cutting of polystyrene, EVA, fiberglass, foam and insulation materials.

### Isolatiemes

Speciaal lemmet voor een gladde, zuivere snede bij het snijden van polystyreen, EVA, glasvezel, schuim- en isolatiematerialen.

### Couteau d'isolation

Lame spéciale lisse pour une coupe propre et droite dans le polystyrène, EVA, la fibre de verre, les mousses et matériaux d'isolation.

### Cuchillo para materiales aislantes

Hoja especial con afilado liso. Para el corte limpio de poliestireno, EVA, fibra de vidrio, espuma y materiales aislantes.

**NEW**

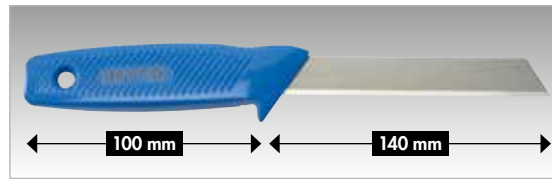

Griff aus kompaktem Zinkdruckguss.  
Handle made by compact die cast zinc.

Bestell-No./Order-No.	Cl mm	g	Stk	€
<b>50816152400</b>	240	160	1	<b>6,90</b>

## 50816154200

### Dämmstoffmesser

Extra starke Klinge, gehärtet und poliert. Klingenspitze geeignet zum Bohren in Dämmstoffen.

Knife for insulating material  
Extra thick blade, hardened and polished. Blade tip for drilling in insulated materials.

### Isolatiemes

Extra sterk lemmet, gehard en gepolijst. Geslepen punt voor het eenvoudig boren in isolatiematerialen.

### Couteau d'isolation

Lame spéciale épaisse, durcie et polie. Pointe pour une entrée facilitée dans les matériaux d'isolation.

### Cuchillo para materiales aislantes

Hoja extra fuerte, endurecida y pulida. Punta de la cuchilla adecuada para perforar en materiales aislantes.

**NEW**

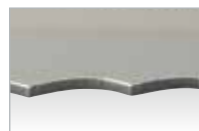

**„Wellenschliff“**  
weite Zahnung für biegsame und weiche Dämmstoffe/Materialien.  
**‘Wave shaped blade’**  
wide toothing for flexible and soft insulation materials.

**„Sägeschliff“**  
enge Zahnung für feste und harte Dämmstoffe/Materialien.  
**‘Saw shaped blade’**  
narrow toothing for solid and hard insulation materials.

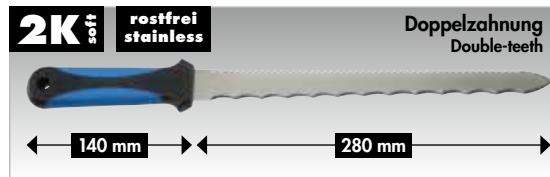

Bestell-No./Order-No.	Cl mm	g	Stk	€
<b>50816154200</b>	420	140	1	<b>9,90</b>

## 5081610

### Metallbügelsäge

Mit Schnellspannvorrichtung 300 mm/12" Blattlänge. Profi-Qualität mit ergonomischem 2-K Griff, geprüfte Qualität. Sägeblatt in verschiedene Winkel verstell- und arretierbar.

### Hacksaw

With click clamp device 300 mm/12" blade length. Profi-quality with 2-K-handle, ergonomically hand mould, certified quality.

### Metaalzaagbeugel

Met snelspanklem, 300 mm/12" zaagblad. Professionele kwaliteit met ergonomische 2 componenten greep, kwaliteit getest. Zaagblad in verschillende hoeken verstel- en draaibaar.

### Scie à métaux

À serrage rapide, lame de 300 mm/12". Qualité professionnelle avec poignée à 2 composantes, qualité certifiée. Lame réglable et verrouillable dans différents angles.

### Sierra para metales

Con dispositivo de sujeción rápida de 300 mm/12" de longitud de hoja. Calidad profesional con mango ergonómico 2-K, calidad probada. Hoja de sierra ajustable y bloqueable en diferentes ángulos.



Lieferumfang mit  
1 Sägeblatt Metall (24T/1")  
1 Sägeblatt Kunststoff/Holz (18T/1")

Included in delivery  
1 saw blade for steel (24T/1")  
1 saw blade for plastics/wood (18T/1")

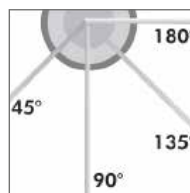

Bestell-No./Order-No.	Art. No.	Cl mm	g	Stk	€
<b>50816100000</b>	5081610	300	530	1	<b>30,70</b>
<b>50816101000</b>	5081610-1	300 für Stahl (24T/1") *	200	1	<b>11,55</b>
<b>50816102000</b>	5081610-2	300 für Kunststoff/Holz (18T/1") *	200	1	<b>11,55</b>

\* 300 mm for steel  
300 mm for plastics/wood  
Sägeblätter 10 Stk. im Set · Saw blades 10 pcs. in the set

## 5081612

### Mini Metallbügelsäge

Mit Schnellspannvorrichtung 150 mm/6" Blattlänge. Profi-Qualität mit ergonomischem 2-K Griff, geprüfte Qualität. Sägeblatt in verschiedene Winkel verstell- und arretierbar.

### Mini Hacksaw

With click clamp device 150 mm/6" blade length. Profi-quality with 2-K-handle, ergonomically hand mould, certified quality.

### Juniorzaagbeugel

Met snelspanklem, 150 mm/6" zaagblad. Professionele kwaliteit met ergonomische 2 componenten greep, kwaliteit getest. Zaagblad in verschillende hoeken verstellen en draaibaar.

### Mini scie à métaux

À serrage rapide, lame de 150 mm/6". Qualité professionnelle avec poignée à 2 composantes, qualité certifiée. Lame réglable et verrouillable dans différents angles.

### Mini sierra para metales

Con dispositivo de sujeción rápida de 150 mm/6" de longitud de hoja. Calidad profesional con mango ergonómico 2-K, calidad probada. Hoja de sierra ajustable y bloqueable en diferentes ángulos.

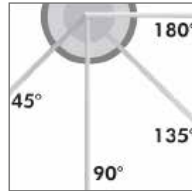

Bestell-No./Order-No.	Art. No.	CLD mm	g	kg	€
<b>50816120000</b>	5081612	150	180	1	<b>13,65</b>
<b>50816121000</b>	5081612-1	150 für Stahl (24T/1") *	30	1	<b>9,40</b>
<b>50816122000</b>	5081612-2	150 für Kunststoff/Holz (18T/1") *	30	1	<b>9,40</b>

\* 150 mm for steel  
150 mm for plastics/wood

## 50816140000

17 Zähne/teeth/tanden/dents/dientes

### Bauhandsäge

Für die Bearbeitung/Sägen von Porenbeton- oder Hohlblocksteinen. Hartmetallbestückt, 17 Zähne, Holzgriff, 700 mm Blattlänge.

### Construction hand saw

For cutting aerated concrete or hollow blocks. Carbide teeth, 17 teeth, wooden handle, 700 mm blade length.

### Gasbetonzaag

Voor het bewerken / zagen gasbeton- of holle blokken. Hardmetalen tanden, 17 tanden, houten greep, zaagblad 700 mm.

### Scie de chantier

Pour la coupe du ciment et des parpaings. 17 dents carbure, poignée en bois, longueur de lame 700 mm.

### Sierra de mano para la construcción

Para el procesamiento/serrado de hormigón celular o bloques huecos. Punta de carburo, 17 dientes, mango de madera, 700 mm de longitud de hoja.

**NEW**



Bestell-No./Order-No.	Art. No.	Maße · Dimensions	g	kg	€
<b>50816140000</b>	5081614	830 x 130 x 25 mm	990	1	<b>46,05</b>

### 508807-1

#### Bohrmaschinen-Gürteltasche, leer

Aus hochwertigem Polyester, für Akkuschauber, Bohrmaschinen oder Bohrschrauber, gepolstert mit Sicherheitschnalle.

Power drill belt pouch, empty  
Made of high quality polyester, for cordless screwdriver, power drill or boring machine, upholstered with safety clasp.

#### Boormachine gereedschapschort, leeg

Van hoogwaardig polyester, voor accuschroefmachines, boormachines of schroefboormachines, gepolstert, met veiligheidsclip.

#### Sac de ceinture pour perceuse, vide

En polyester de haute qualité, pour perceuse-visseuse électrique, rembourré et équipé d'une boucle de sécurité.

#### Cinturón portaherramientas para taladros, vacío

De poliester de alta calidad, para destornilladores eléctricos, taladros o taladro atornillador, acolchado con hebilla de seguridad.



Bestell-No./Order-No.	Art. No.	Maße · Dimensions			€
<b>50880700100</b>	508807-1	160 x 360 x 90 mm	217	1	<b>21,00</b>

### 508807-2

#### Gürteltasche, leer

Aus hochwertigem Polyester, gepolstert mit Hammerring, viel Platz für Werkzeug und Kleinteile sowie Aufnahmeplatz für Maßbänder und Halter für Isolierbandrollen. Ideal für Elektriker, Zimmermänner und Sanitär.

Belt pouch, empty  
Made of high quality polyester with hammering, space for tools, small parts and position point for measuring tapes. Ideal for electricians, carpenters and plumbers.

#### Gereedschapsschort, leeg

Van hoogwaardig polyester, gepolstert, met hamerbeugel, veel ruimte voor gereedschap en kleine onderdelen, met opbergvak voor rolbandmaten en houder voor isolatietape. Ideaal voor elektriciens, timmerlieden en loodgieters.

Porte-outils à ceinture, vide  
En polyester de haute qualité, avec bague de suspension pour marteau, beaucoup de place pour les outils et les petites pièces et attache pour mètre-ruban. Idéal pour électriciens, charpentiers et plombiers.

#### Cinturón portaherramientas, vacío

De poliester de alta calidad con ruedo para martillos, mucho espacio para herramientas y piezas pequeñas así como punto de referencia para las cintas métricas. Ideal para electricistas, carpinteros y fontaneros.



Bestell-No./Order-No.	Art. No.	Maße · Dimensions · Medidas			€
<b>50880700200</b>	508807-2	380 x 300 x 100 mm	344	1	<b>26,35</b>



## FÜR JEDE ANWENDUNG DAS RICHTIGE EQUIPMENT

Ob auf der Baustelle oder beim täglichen Einsatz im Reparaturservice – Werkzeuge brauchen einen angemessenen Stauraum, um transportiert werden zu können. In der oftmals rauen Arbeitswelt haben sich unsere Taschen dafür hervorragend bewährt. Sie bieten nicht nur eine übersichtliche Anordnung der Werkzeuge, sie sind darüber hinaus extrem robust und, was besonders wichtig ist, sie bieten einen enormen Tragekomfort und zeichnen sich durch universelle Bestückungsmöglichkeiten aus.

## THE RIGHT EQUIPMENT FOR EVERY JOB

Whether on a building site or for the everyday tasks of repair services – tools need to be appropriately stowed for transportation. Our tool bags have proved their outstanding robustness and resilience in often harsh working conditions. They not only offer clear organisation of the tools, they are also extremely robust and, especially important, offer outstanding carrying comfort and are characterised by universal equipping options.



### 508807-3

#### Gürteltasche, leer

Aus hochwertigem Polyester, Facheinteilung für Zangen, Schraubendreher, Bandmaß und Halter mit Isolierband-rollen. Ideal für Elektriker, Zimmermänner und Sanitär.

#### Belt pouch, empty

Made of high quality polyester, space for pliers, screwdrivers, measuring tapes and holder for insulating tapes. Ideal for electricians, carpenters and plumbers.

#### Gereedschapsschort, leeg

Van hoogwaardig polyester, vakindeling voor tangen, schroevendraaiers, rolbandmaat en houder voor isolatietape. Ideaal voor elektriciëns, timmerlieden en loodgieters.

#### Porte-outils à ceinture, vide

En polyester de haute qualité, emplacements pour pinces, tournevis, mètre-ruban et support pour rouleaux de bandes isolantes. Idéal pour électriciens, charpentiers et plombiers.

#### Cinturón portaherramientas, vacío

De poliester de alta calidad, bolsillos para alicates, llaves de vaso, cinta métrica y soporte para rollos de cinta aislante. Ideal para electricistas, carpinteros y fontaneros.



Bestell-No./Order-No.	Art. No.	Maße · Dimensions			€
<b>50880700300</b>	508807-3	460 x 270 x 320 mm	344	1	<b>28,45</b>

### 508807-4

#### Hammer-Gürteltasche, leer

Aus hochwertigem Polyester mit schwenkbarem Stahlbügel für alle Hammerarten inklusive Halterung für Gerüstbauknarren.

#### Hammer belt pouch, empty

Made of high quality polyester with swivelling steel clevis for all type of hammers, including holder for construction tool.

#### Hamerholster, leeg

Fan hoogwaardig polyester met zwenkbare stalen beugel voor alle typen hamers, incl. houder voor verfpuntratel.

#### Porte-marteau à ceinture, vide

En polyester de haute qualité avec étrier en acier orientable pour tous types de marteaux et supports pour clés à cliquet d'échaffaudage.

#### Cinturón portaherramientas para martillos, vacío

De poliester de alta calidad con colgador de acero para todo tipo de martillos incluido soporte para herramientas para el montaje de andamios.

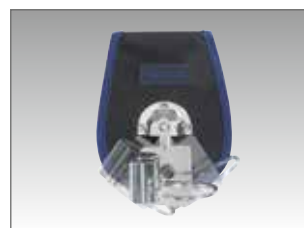

Bestell-No./Order-No.	Art. No.	Maße · Dimensions			€
<b>50880700400</b>	508807-4	280 x 170 x 90 mm	500	1	<b>21,05</b>

# AUSSTELLUNGS- UND VERKAUFSLOCHWÄNDE EXHIBITION AND SALES DISPLAYS





**5 Bausteine  
für erfolgreiche Warenpräsentation:**

- Top-modisches Design
- Anschauliche Anwendungsbeispiele
- Herausgestellte Besonderheiten
- Bedarfsgerechte Bestückung
- Einheitliches Erscheinungsbild

**5 elements  
for successfull presentation:**

- Advanced design
- Examples for applications
- Exposed features
- Assortment as per market demand
- Consistent appearance

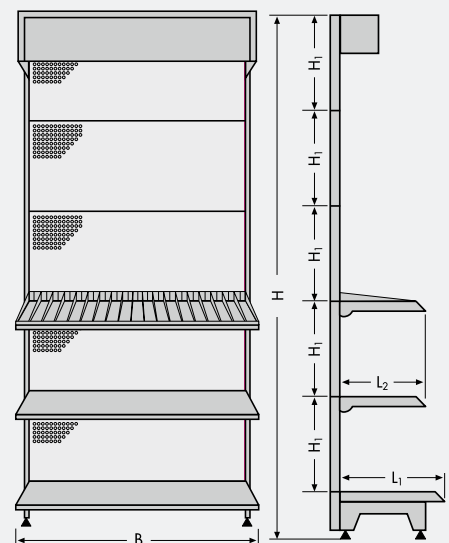

- $B = 665 \cdot 1000 \cdot 1250 \cdot 1333 \text{ mm}$   
 $H = 1410 \cdot 1610 \cdot 2010 \cdot 2210 \cdot 2410 \text{ mm}$   
 $H_1 = 400 \text{ mm}$   
 $L_1 = 570 \text{ mm}$   
 $L_2 = 250 \cdot 300 \cdot 370 \cdot 470 \text{ mm}$

Nummernliste, Numerical list, Nummerlijst, Liste des references, Lista de referencias

Code	EAN 4024089 +	Code	EAN 4024089 +	Code	EAN 4024089 +	Code	EAN 4024089 +
1128110200	172041	50740192236	166941	50805242780	324303	50810030080	170726
50214500100	394252	50742192280	394047	50805252880	324310	50810032080	170719
50214500200	394269	50750010080	061956	50805303280	324327	50810036080	370676
50253320834	058260	50750010080	061956	50805420680	347494	50810041080	371291
50720008080	123869	50750010180	061963	50805420780	347500	50810061980	331578
50720009080	123852	50750010180	061963	50805420880	347517	50810062180	331585
50720010080	123845	50780809580	339086	50805420980	347524	50810062280	331592
50720011080	123838	50800021200	334005	50805421080	347531	50810062380	331608
50720012080	123821	50800060780	170597	50805421180	347548	50810062480	331615
50720013080	123814	50800080980	170603	50805421280	347555	50810062680	331622
50720014080	123807	50800081080	325805	50805421380	347562	50810062780	331639
50720015080	123791	50800101180	170610	50805425580	347487	50810062980	331646
50720016080	123784	50800101380	173697	50805429080	356267	50810063080	331653
50720017080	123777	50800111380	314014	50805644080	347654	50810063280	331660
50720018080	123760	50800121380	170627	50805747080	331844	50810063480	406610
50720019080	123753	50800131580	325829	50805944080	324334	50810063580	331677
50720022080	364866	50800131780	325836	50805947080	324341	50810063680	331684
50720024080	364873	50800141580	170634	50807694500	346633	50810063880	331691
50720027080	364897	50800161780	170641	50807696100	416282	50810064180	331707
50720600080	125818	50800161880	325843	50807696200	416275	50810064680	331714
50720600180	128895	50800171980	173680	50807740100	416244	50810065080	331721
50720600280	133394	50800181980	170658	50807740200	416237	50810065580	406627
50720600380	325560	50800192280	325850	50807740300	416220	50810066080	406634
50725008080	169911	50800202280	170665	50807740400	416312	50810131080	329254
50725009080	169928	50800212380	170672	50807764600	363357	50810140180	394214
50725010080	169935	50800242780	170689	50807892000	384956	50810520000	405279
50725011080	169942	50800252880	170696	50810000680	331776	50810522700	409000
50725012080	169959	50800273080	173673	50810003080	331769	50810522800	409017
50725013080	169966	50800303280	170702	50810004080	331745	50810525000	409031
50725014080	169973	50800323680	370652	50810004180	331738	50810529200	409024
50725015080	169980	50800330683	332353	50810005080	331752	50810627380	345896
50725016080	169997	50800364180	370669	50810006080	170917	50810724280	325188
50725017080	170009	50800414680	391428	50810007080	170900	50810727180	307986
50725018080	170016	50800644080	345902	50810008080	170894	50810727280	307962
50725019080	170023	50800747080	334012	50810009080	170887	50810729480	339574
50725022080	170030	50800844080	174168	50810010080	170870	50810824280	174175
50725024080	170047	50800944080	171198	50810011080	170863	50810827180	174151
50725027080	364903	50800947080	171181	50810011380	408072	50810924280	171143
50725030080	364910	50801329080	364859	50810012080	170856	50810927180	171150
50725032080	364927	50805060780	324204	50810013080	170849	50810927280	311105
50725600080	174571	50805080980	324228	50810014080	170832	50810929080	171167
50725600180	174588	50805101180	324235	50810015080	170825	50810929480	171174
50725600280	174953	50805101380	340570	50810016080	170818	50811290120	326604
50725600380	304428	50805121380	324242	50810017080	170801	50811291500	341997
50725600580	392944	50805141580	324259	50810018080	170795	50811292500	342079
50730081383	348224	50805161780	324266	50810019080	170788	50811292600	395716
50730091583	348231	50805171980	340587	50810020080	170771	50811292700	395723
50730101983	363166	50805181980	324273	50810021080	170764	50811292800	355093
50730161983	348248	50805192280	386554	50810022080	170757	50811300120	399684
50730202483	348255	50805202280	324280	50810024080	170740	50811302600	406092
50730600183	348262	50805212380	324297	50810027080	170733	50811302700	406115

Code	EAN 4024089 +	Code	EAN 4024089 +	Code	EAN 4024089 +	Code	EAN 4024089 +
50812001842	345261	50814240050	306682	50816210132	356410	50820077200	416190
50812001888	370539	50814260000	368833	50816402500	359664	50820160900	404876
50812082042	345223	50814280000	394245	50816403200	359626	50820161483	405620
50812082088	370522	50814400000	356762	50816404200	359640	50820176200	416183
50812092042	345230	50814900000	369076	50816430100	353419	50822500780	356786
50812092088	370492	50814910400	368840	50816430100	353419	50825006583	395495
50812121842	345254	50814910500	368857	50816430200	359848	50825015083	329872
50812121888	370508	50814910600	368864	50816430200	359848	50825017083	364088
50812131642	345247	50814910800	368871	50816430300	361872	50825018083	369045
50812131688	370485	50814911000	368888	50816431500	361643	50825018083	369045
50812201688	370515	50814912000	368949	50816432200	359633	50825030083	331011
50812211900	370775	50814913000	368956	50816464200	380071	50825040083	329889
50812412213	332179	50814920400	368895	50816470000	380064	50825050083	329896
50812412513	388190	50814920500	368901	50816473500	380057	50825055083	350104
50812422013	385960	50814920600	368918	50816480000	380422	50825056083	369052
50812501750	448436	50814920800	368925	50816480200	380439	50825057083	369069
50812590000	376470	50814921000	368932	50816680000	370553	50825060083	329902
50812590100	380347	50814922000	368963	50816690000	362633	50825080083	329919
50812591200	379211	50815003880	334357	50816691200	362640	50825101680	382303
50812650000	393316	50815005080	364972	50816700800	386929	50825101783	392203
50812670000	393323	50815013800	334364	50816752000	359961	50825111583	365887
50812802550	356144	50815015000	364989	50816762000	359978	50825121083	323948
50813301020	358995	50815160021	353747	50816772000	359985	50825150183	394160
50813301520	359008	50815160120	365139	50816782000	359992	50825190683	329926
50813311020	386127	50815180000	442939	50816792000	360004	50825190783	329933
50813311520	386011	50815181021	331547	50816800500	360011	50825190883	329940
50813380080	347586	50815182021	442946	50816852000	435788	50825190983	329957
50813380280	347319	50815230021	326208	50817200000	356847	50825191083	329964
50813380380	347333	50815250021	326215	50817210300	448412	50825191183	329971
50813380480	347340	50815302700	371239	50817300000	356830	50825191283	329988
50813380580	347357	50815303500	371208	50817310000	380248	50825191383	329995
50813380680	347364	50815312700	371277	50817320000	385847	50825191483	331028
50813380880	347371	50815313500	371284	50817330800	386875	50825200483	345933
50813381080	347388	50815322700	371253	50817330900	386882	50825200583	345940
50813382580	347326	50815323500	371260	50817560100	380231	50825200683	345957
50813406280	347067	50815770900	434583	50817900120	428148	50825200783	345964
50813438280	347074	50815771200	434590	50817910000	373387	50825200883	345971
50813448280	386936	50816100000	361933	50817910100	373394	50825201083	345988
50813470080	347593	50816101000	361919	50817910200	386912	50825201183	345995
50813471080	347395	50816102000	361926	50817910300	390629	50825300383	330007
50813471580	347401	50816110100	404340	50817912200	387292	50825300483	330014
50813472080	347418	50816120000	361940	50817912300	390636	50825300583	331035
50813472580	347425	50816121000	361896	50817919000	374674	50825301583	328646
50813472780	347432	50816122000	361902	50818350000	360592	50825310183	330021
50813473080	347449	50816130000	423327	50818350100	402353	50825310283	330038
50813474080	347456	50816131000	423334	50818360000	406658	50825310383	330045
50813474580	347463	50816132000	423341	50818360300	448443	50825310483	330052
50813475080	347470	50816133000	423358	50818393000	386356	50825310583	450736
50813486280	347050	50816140000	443103	50818393200	386417	50825320183	331042
50813488280	347043	50816152400	449617	50820064600	416213	50825320283	331059
50813498280	386943	50816154200	449624	50820077100	416206	50825320383	331066

Nummernliste, Numerical list, Nummerlijst, Liste des references, Lista de referencias

Code	EAN 4024089 +	Code	EAN 4024089 +	Code	EAN 4024089 +	Code	EAN 4024089 +
50825330183	331103	50829001986	386431	50840041083	331189	50845367533	332223
50825330283	331097	50829003083	346602	50840060083	330281	50845500033	387995
50825330383	331110	50829003100	346572	50840101783	392210	50845600080	409338
50825350183	330069	50829003200	346589	50840121383	323955	50845640080	387988
50825350283	330076	50829003380	346619	50840140083	330298	50846000033	369113
50825350383	331127	50829003480	346596	50840140183	394177	50847000033	373677
50825370883	331141	50829003580	346626	50840150083	330328	50848002600	381252
50825371083	331134	50829005000	394757	50840150083	330328	50848002700	381238
50825371583	330083	50829005100	394801	50840150183	394184	50848010000	380088
50825372083	330090	50829005200	394795	50840190183	330335	50849000900	449648
50825372583	330106	50829005300	394825	50840190383	330953	50849001400	377842
50825372783	330113	50829005400	394771	50840301583	328653	50849401680	410419
50825373083	330120	50829005500	394764	50840600883	330359	50850006583	395501
50825374083	331158	50829005600	394788	50840600983	330366	50850015083	330519
50825501583	328639	50829005700	394863	50840601083	330373	50850030083	332377
50825506583	395518	50829301683	381009	50840601183	330380	50850040083	330526
50825600483	330137	50829301783	353099	50840601283	330397	50850045083	350081
50825600583	330144	50829301883	365658	50840601383	330403	50850050083	330540
50825600683	330151	50829301983	389975	50840601483	330410	50850055083	350098
50825600783	330168	50829302083	423211	50840601583	330427	50850055483	394023
50825600883	330175	50830000000	356854	50840601683	330434	50850055583	394030
50825600983	330182	50833010080	379235	50840601783	330458	50850060083	330557
50825601083	330199	50833010080	379235	50840601883	330472	50850101680	382310
50825601183	330205	50833046500	387315	50840601983	330489	50850101783	392227
50825601283	330212	50833200000	327465	50840602083	331196	50850121983	323962
50825601383	330229	50833201000	390711	50840602183	330496	50850140183	394191
50825601483	330236	50833300000	381528	50840602283	330502	50850141083	331219
50825601583	331165	50833300100	381535	50840602483	331202	50850141083	331219
50825604583	330243	50833400000	387407	50842301583	388206	50850150183	394207
50825605583	330250	50833401200	390704	50845110133	375633	50850160183	442137
50825710083	435030	50833500000	404357	50845110180	326468	50850190183	330564
50825711983	435047	50833501000	404364	50845110233	375626	50850190383	330571
50825713783	435054	50833900000	371437	50845110280	326475	50850190483	433913
50825719983	435061	50834000000	368970	50845110333	375619	50850191083	330588
50828301583	369649	50834000100	368987	50845120133	332261	50850191383	330595
50829000280	332131	50834300700	369014	50845120180	409406	50850191483	330601
50829000380	332117	50834310800	369021	50845120233	332278	50850191583	330618
50829000480	332100	50834320400	369007	50845120280	409413	50850191783	330625
50829000500	332124	50834350200	369038	50845120333	375640	50850191983	330632
50829000880	332162	50834370900	368994	50845151080	409260	50850192283	331226
50829000980	332155	50835000000	402377	50845151580	409277	50850192483	331233
50829001033	332292	50839000100	202571	50845152080	409284	50850201083	346008
50829001100	332094	50839000680	176940	50845152580	409291	50850201183	346015
50829001383	332209	50839000880	176933	50845152780	409307	50850201283	346022
50829001383	332209	50839001080	177206	50845153080	409314	50850201483	346039
50829001483	332285	50839001088	371680	50845154080	409321	50850201683	346046
50829001542	348163	50839001280	313512	50845300480	326437	50850201883	346053
50829001680	350241	50839900480	365870	50845305580	326444	50850202083	346060
50829001783	350654	50840015083	330267	50845306580	326451	50850202283	346077
50829001800	381283	50840030083	332360	50845361033	332230	50850202483	346084
50829001800	381283	50840040083	330274	50845361233	332247	50850310083	349276

Code	EAN 4024089 +	Code	EAN 4024089 +	Code	EAN 4024089 +	Code	EAN 4024089 +
50850310183	349283	50850340583	349566	50850600983	331295	50870301583	341935
50850310283	339819	50850340683	349573	50850601083	330649	50870311583	341942
50850310383	339826	50850340783	349580	50850601183	330656	50872301583	348590
50850310483	339833	50850342183	349597	50850601283	330670	50873301583	348583
50850310583	339840	50850342283	349603	50850601383	330687	50879000080	364811
50850310683	339857	50850342383	349610	50850601483	330694	50880000020	395488
50850310783	349290	50850342483	349627	50850601583	330700	50880000080	348156
50850310883	349306	50850342583	349634	50850601683	330823	50880700100	364774
50850310983	349313	50850342683	349641	50850601783	330717	50880700200	364781
50850311083	350159	50850342783	349658	50850601883	330724	50880700300	364798
50850311183	339987	50850360383	349825	50850601983	330731	50880700400	364804
50850311283	339970	50850360483	349832	50850602083	330748	50881000600	390490
50850311383	350128	50850360683	349849	50850602183	330755	50882000080	307337
50850311483	339956	50850360883	349856	50850602283	330762	50883301683	381030
50850311583	339963	50850361083	349429	50850602383	331301	50885000080	176957
50850311683	350135	50850361183	349436	50850602483	330779	50886000080	371307
50850311783	350142	50850361283	349443	50850602783	330786	50888021080	444728
50850311883	339994	50850361383	349450	50850603083	330793	50888035080	444735
50850311983	350166	50850361483	349467	50850603283	330816	50889694400	448405
50850312283	350173	50850361583	349474	50850603483	433890	50890300200	339567
50850312483	350180	50850361683	349481	50850603683	433906	50890300300	381269
50850312583	350197	50850361783	349498	50850631983	382143	50895100080	371413
50850312683	350203	50850361883	349504	50850632183	382150	50895311380	371321
50850312783	350210	50850361983	349511	50850632383	382167	50895311480	371338
50850312883	434705	50850362083	349320	50850632583	382174	50895311780	371345
50850312983	434729	50850362583	349337	50850632783	382181	50895311880	371352
50850313083	434712	50850362783	349344	50850632983	382198	50895311980	371369
50850313183	435016	50850363083	349351	50850633183	382204	50895312280	371376
50850313283	435023	50850364083	349368	50850633383	382211	50895312480	371383
50850330183	349665	50850364583	349375	50850633483	382228	50895312780	371390
50850330283	349672	50850365083	349382	50850633583	382235	50895313080	371406
50850330383	349689	50850365583	349399	50850633783	382242	50896101360	443035
50850330483	349696	50850366083	349405	50850633883	382259	50896111260	443042
50850330583	349702	50850367083	349412	50850633983	382266	50898101260	339550
50850330683	349719	50850372083	340020	50850634083	382273	50899000560	441918
50850330783	349726	50850372583	340037	50850634183	382280	50958171980	144185
50850331283	349894	50850372783	340044	50850790083	388558	58103000100	164336
50850331483	349900	50850373083	331240	50851301583	328677	90050160083	074857
50850331583	349917	50850374083	331257	50852201683	381016	90050160083	074857
50850331683	349863	50850374583	331264	50853301583	328660	90050400080	142389
50850332183	349733	50850375083	331271	50854301683	381023	90833120305	331530
50850332283	349740	50850375583	349801	50860301580	318913	90880701500	331486
50850332383	349757	50850376083	349818	50863000300	331790	90950103220	144192
50850332483	349764	50850530083	346367	50863001760	332001	90955020020	144215
50850332583	349771	50850540083	346374	50863001960	332018	98076080020	089257
50850332683	349788	50850550083	346381	50863002160	332025	98263060080	090949
50850332783	349795	50850551283	346398	50863190300	331806	98718500000	387841
50850340183	349528	50850560283	346428	50863191760	332032		
50850340283	349535	50850580083	405798	50863191960	332049		
50850340383	349542	50850590083	346411	50863192160	332056		
50850340483	349559	50850600883	331288	50867500000	395228		

## Inhaltsverzeichnis

Artikel	
<b>A</b>	
Abdeckhaube für Werkstattwagen	76
Abisolierzange	133
Abzieher	141
Adapter 1/4"	33
Adapter 3/8"	43/44
Adapter 1/2"	49
Adapter 3/4"	65
Adapter für Knarren-Ringmaulschlüssel	24
Arbeitshandschuhe	178
Arbeitslampe	116
<b>B</b>	
Bandmaß	138
Bit-Adapter	38
Bit-Box-Satz	36-37
Bithalter	145
Bit-Knarre 1/4"	30
<b>C</b>	
Crimpzange	129
Cuttermesser	137
<b>D</b>	
Dämmstoffmesser	181
Doppelmaulschlüssel	14
Doppelringschlüssel	18
Drahtsäge	171
Drehmomentschlüssel	101-103
Dreikant-Rohrsteckschlüssel	155
Dreikant-Steckschlüssel	155
Durchsteckknarre 1/2"	46/172
Durchsteckknarre 3/4"	64
<b>E</b>	
Eckrohrzangen	109
Einmaulschlüssel	16
Einsatzspender	54-55
Einsteckknarre 1/2"	103
Einsteckmaulschlüssel 1/2"	103
Express-Schlüssel	171
<b>F</b>	
Feinmechaniker-Bitsatz	142
Feinmechaniker-Schraubendrehersatz	142
Flachrundzange	110
Fugenabzieher	167
<b>G</b>	
Gerüstbauknarre	25
Gewindeschneidwerkzeug	141
Gleitstück	43/49
Griff mit Gleitstück 1/4"	30
Griff mit Gleitstück 3/8"	43
Griff mit Gleitstück 1/2"	48
Griff mit Gleitstück 3/4"	64
Gripzange	115
Gürteltaschen	183/185

Artikel	
<b>H</b>	
Hämmer	151-153
Hammeraufsatz	151
Handfeile	139
Handhebelfettpresse	168
Handsäge	179/182
Hebelblechschere	115
Hebelumschaltknarren 1/2"	47
Hebelumschaltknarren 1/4"	28/29
Hebelumschaltknarren 3/8"	42
<b>I</b>	
Impact-Steckschlüssel	108
<b>J</b>	
Japansäge	179
JUNIOR Werkzeugkasten	88
<b>K</b>	
Kabelmesser	133
Kantenzange	112
Kapsel-Gehörschutz	178
Kardangelenk 1/4"	31
Kardangelenk 3/8"	43
Kardangelenk 1/2"	49/173
Kartuschenpistolen	166/167
Knarren 1/4"	28/30
Knarren 3/8"	42
Knarren 1/2"	46/47
Knarren-Ringmaulschlüssel	20-24
Kneifzange	111
Kombinationszange	110
Kraftseitenschneider	111
Kugelkopf-Winkelschraubendrehersatz	147
Kupferrohrrbürste	171
<b>M</b>	
Magnetisierer / Entmagnetisierer	149
Montagezangen-Satz	112
Metallbügelsäge	181/182
Module für Werkstattwagen	77-85
Montage-Werkzeugkasten	88-91
Montage-Werkzeugkoffer	94
Montage-Werkzeugsortiment im Rucksack	98/99/120
Montage-Werkzeugsortiment in Umhängetasche	95
Montage-Werkzeugsortiment L-BOXX®	93
Montiereisen	156
Multifunktionszange	114
<b>Ö</b>	
Ölbrennerschlüssel	174
Ölfilterspinne	155
<b>P</b>	
Präzisions-Maßstab, 300 mm	137
<b>R</b>	
Rabitzzange	111
Radwechsel-Werkzeugsatz	106



## Inhaltsverzeichnis

Artikel	
Ringmaulschlüssel	15
Rohrabschneider	169/170
Rohrentgrater	170
Rohrsteckschlüssel	174
Rucksäcke	97-99/120/121
<b>S</b>	
Sägeblätter	180
Sanitär Werkzeugkasten	160
Sanitär-Garnitur	173
Sanitärkreuzschlüssel	175
Sanitär-Werkzeugsortiment L-BOXX®	163-165
Sanitär-Werkzeugsortimente	163-165
Saugheber	168
Schlauchschneidezange	115
Schraubendreher	144
Schraubendreher-Einsätze 1/4"	32
Schraubendreher-Einsätze 1/2"	52/53/61-63
Schraubendreher-Einsatz-Sortimente	35/61/62
Schutzbrille	178
Sechskant-Schraubendreher	146
Seitenschneider	111
Spannungsprüfer	130/132
Splinttreibersatz	140
Stablampe	116
Standhahnmutternschlüssel	175
Steckgriff	31
Steckschlüssel	145
Steckschlüssel- und Bitsgarnitur 1/4"	40/41
Steckschlüssel- und Ringmaulschlüsselgarnitur 1/2"	63
Steckschlüsseleinsätze 1/4"	32/32
Steckschlüsseleinsätze 3/8"	44
Steckschlüsseleinsätze 1/2"	50/51
Steckschlüsseleinsätze 3/4"	65
Steckschlüsselgarnituren 1/4"	35/39-41
Steckschlüsselgarnituren 3/8"	45
Steckschlüsselgarnituren 1/2"	56-60/63
Steckschlüsselgarnituren 3/4"	67
Stirnleuchte	116
Stufenschlüssel	172/173
<b>T</b>	
Taschen	120-125
T-Griff mit Knarrenfunktion 1/4"	29/39
TORX®-Schraubendreher	144/147/148
TORX®-Winkelschraubendreher	148/149
<b>U</b>	
Umhängetaschen	121
Umschaltknarre 3/4"	64
Universal-Schere	112
<b>V</b>	
VDE Abisolierzange	127
VDE Einmaulschlüssel	133
VDE Flachrundzange	126

Artikel	
VDE Kombinationszange	126
VDE Kraftseitenschneider	127
VDE Schraubendreher	132
VDE Seitenschneider	127
VDE Werkzeugsätze	123-125/128
Verbindungsvierkant	46/172
Verlängerungen 1/4"	30
Verlängerungen 3/8"	43
Verlängerungen 1/2"	48
Verlängerungen 3/4"	65
<b>W</b>	
Wasserpumpenzange	109
Wasserwaage	136
Werkstattfeilen	139/140
Werkstattwagen mit Modulen	72-74
Werkstattwagen Zubehör	76
Werkzeugrolltasche	154
Werkzeugsatz mit Meißel, Körner, Splint- und Durchtreiber	140
Winkelschraubendreher	146
<b>Z</b>	
Zimmermannswinkel	138
Zündkerzeneinsätze 3/8"	44
Zündkerzeneinsätze 1/2"	51

## Index

Article	
<b>A</b>	
Adapter for combination ratchet wrenches	24
Adjustable wrenches	16
<b>B</b>	
Backpacks	97-99/120/121
Basin wrench	175
Belt pouch	183/185
Bit ratchet 1/4"	30
Bit-Adapter	38
Bit-box-set	36-37
Bitholder	145
<b>C</b>	
Cable folding knife	133
Carpenter's square	138
Chisel and pin punch set	140
Circlip plier set	112
Combination plier	110
Combination ratchet wrenches	20-24
Combination stepped key	172/173
Combination wrenches	15
Construction tool case	94
Converter 1/2"	49
Converter 1/4"	33
Converter 3/4"	65
Converter 3/8"	43/44
Copper tube pouch	171
Crimping tool	129
Cutting knife	181
<b>D</b>	
Diagonal cutting nipper	111
Die cutting tool	141
Double ended open jaw wrenches	14
Double ended ring wrenches	18
Double ended tubular socket wrench	174
<b>E</b>	
Elbow pipe wrenches	109
End cutting plier	112
Engineers' files	139/140
Extension bars 1/2"	48
Extension bars 1/4"	30
Extension bars 3/4"	65
Extension bars 3/8"	43
<b>F</b>	
Foldable ear muff	178
<b>G</b>	
Grip pliers	115

Article	
<b>H</b>	
Hacksaw	181
Hammers	151-153
Hammer attachment	151
Hand file	139
Handsaw	179
Handy screeding pads	167
Hexagonal head wrenches	146
Hose cutting pliers	115
<b>I</b>	
Impact sockets	108
<b>J</b>	
Japanese Saw	179
JUNIOR Tool box	88
<b>L</b>	
LED Headlamp	116
LED Torchlight	116
Lever plate shear, straight, right hand cutting	115
Lever type reversible ratchet 1/2"	47
Lever type reversible ratchet 1/4"	28/29
Lever type reversible ratchet 3/4"	64
Lever type reversible ratchet 3/8"	42
L-shaped TORX®-Wrenches	148/149
<b>M</b>	
Magnetizer / demagnetizer	149
Measuring tape	138
Modules for workshop trolleys	77-85
Multifunction plier	114
<b>N</b>	
Nut spinner	145
Nylon cover for workshop trolley	76
<b>O</b>	
Oil burner key	174
Open ended jaw wrench insert tools 1/2"	103
<b>P</b>	
Pin punches set	140
Precision bit-set	142
Precision rule, 300 mm	137
Precision screwdriver set	142
Professional universal scissors	112
Profi caulking guns	166/167/168
Protective glasses	178
Protective gloves	178
Pullers	141
<b>R</b>	
Ratchet 1/2"	46/102/172/173

## Index

Article	
Ratchet 3/4"	64/102/172
Ratchets 1/2"	102
Ratchets 1/4"	30/102
Ratchets 3/8"	102
Reversible ratchet heads 1/2"	103
<b>S</b>	
Sanitary cross wrench	175
Sanitary tools	160, 163-165, 173
Sanitary wrench	171
Saw blades	180
Scaffolding ratchet	25
Screwdriver socket sets	35/61/62
Screwdriver sockets 1/2"	52/53/61-63
Screwdriver sockets 1/4"	32
Screwdrivers	144
Self-gripping oil filter wrench	155
Set of ball head hexagonal wrenches	147
Set of sockets and combination wrenches 1/2"	63
Shoulder bags	121
Sliding T-head	30/43/49
Snipe nose plier	110
Socket- and bit-set 1/4"	40/41
Socket dispenser	54/55
Socket sets 1/2"	56-60/63
Socket sets 1/4"	35/39-41
Socket sets 3/4"	67
Socket sets 3/8"	45
Sockets 1/2"	50
Sockets 1/4"	31/32
Sockets 3/4"	65
Sockets 3/8"	44
Spark plug sockets 1/2"	51
Spark plug sockets 3/8"	44
Spinner handle	31
Spirit Level	136
Square coupler	46/172
<b>T</b>	
T-handle with ratchet 1/4"	29/39
Tool assortment in backpack	98/99/120
Tool assortment in shoulder bag	95
Tool assortment set L-BOXX®	93
Tool box, cantilever type	88-91
Tool wallet	154
Torque wrenches	101-103
TORX®-Screwdrivers	144/147/148
Tower pincers	111

Article	
Tube cutter	169/170
Tube trimming tool	170
Tubular triangular wrench	155
Tyre lever	156
<b>U</b>	
Universal joint 1/2"	49/173
Universal joint 1/4"	31
Universal joint 3/8"	43
Utility knife	137
<b>V</b>	
Vacuum lifting pad	168
VDE Adjustable wrench	133
VDE Combination plier	126
VDE Diagonal cutting nipper	127
VDE Snipe nose plier	126
VDE Tool sets	123-125/128
VDE Wire stripping pliers	127
VDE-Screwdriver	132
Voltage tester	130/132
<b>W</b>	
Water pump pliers	109
Wheel changing tool set	106
Wire saw	171
Wire stripping plier	133
Working lamp	116
Workshop trolley accessories	76
Workshop trolley with modules	72-74

# Verkaufs-, Lieferungs- und Zahlungsbedingungen

## 1. Anerkennung der Verkaufs-, Lieferungs- und Zahlungsbedingungen

Unsere Verkäufe basieren auf den nachstehenden Bedingungen, wobei jeweils nur die neuesten Verkaufsunterlagen Gültigkeit besitzen. Abweichungen oder mündlich getroffene Nebenabsprachen bedürfen unserer schriftlichen Bestätigung. Bedingungen der Besteller können wir nicht anerkennen, auch dann nicht, wenn von uns nicht ausdrücklich widersprochen wird. Der Besteller erkennt durch die Erteilung seines Auftrages unsere Bedingungen an. Vertragsgültigkeit wird erst durch unsere schriftliche Auftragsbestätigung erreicht.

## 2. Angebote

Unsere Angebote sind freibleibend, Katalog und Preisliste sind Bestandteile unseres Angebotes. Maß- und Gewichtsangaben sowie Abbildungen, Leistungsbeschreibungen, technische Zeichnungen und Daten sind unverbindlich, sofern sie nicht ausdrücklich als verbindlich bestätigt werden, sie können jederzeit und ohne besondere Anzeige geändert werden.

## 3. Schutzrechte

Werkseigene Zeichnungen, Abbildungen, Photos und sonstige Unterlagen bleiben auch nach Weitergabe an den Besteller oder an Dritte unser Eigentum und unterliegen dem Urheberrecht. Ohne unsere Erlaubnis dürfen diese weder vervielfältigt noch anderen zugänglich gemacht werden. Sie sind an einem sicheren Ort aufzubewahren und auf Verlangen an uns zurückzugeben. Werden bei der Anfertigung von Waren nach Zeichnungen, Mustern bzw. sonstigen Angaben des Bestellers Schutzrechte Dritter verletzt, so stellt dieser uns von sämtlichen Ansprüchen frei.

## 4. Sonderanfertigungen

Bei Sonderanfertigungen behalten wir uns das Recht einer Mehr- bzw. Minderlieferung bis zu 10 % vor. Hierzu zählen ebenfalls Serienteile, die auf ausdrücklichen Wunsch des Bestellers besonders zu zeichnen sind. Der Besteller kann nicht vom Auftrag zurücktreten; besonders hergestellte oder gezeichnete Ware wird von uns nicht zurückgenommen.

Im Falle von Zahlungsunfähigkeit bzw. Konkurs des Bestellers behalten wir uns das Recht vor, die Ware direkt zu verkaufen. Bei Herstellung nach Unterlagen des Bestellers haftet dieser für die Richtigkeit seiner Zeichnungen, Muster, Lehren usw. Muster werden grundsätzlich nur gegen Berechnung geliefert.

## 5. Preise

Unsere Preise sind freibleibend in EUR und als unverbindliche Preisempfehlung anzusehen. Sie verstehen sich ausschließlich Mehrwertsteuer, wobei der am Tage der Lieferung gültige Mehrwertsteuersatz Anwendung findet.

Eine Berichtigung unserer Preise behalten wir uns vor, sofern bis zum Tage der Lieferung Änderungen in den Grundkosten, wie Rohmaterial, Energie, Löhne usw. eintreten. Lieferungen erfolgen grundsätzlich in den im Katalog genannten Verpackungseinheiten. Kleinere oder durch die Verpackungseinheiten nicht teilbare Mengen werden lose in Papier verpackt und mit einem Aufschlag von 25 % belastet, sofern in unseren Verkaufsunterlagen kein anderweitiger Vermerk gemacht wird.

## 6. Zahlungsbedingungen

Unsere Rechnungen sind zahlbar Inland: 10 Tage nach Rechnungsdatum abzüglich 2 % Skonto oder 30 Tage nach Rechnungsdatum netto, falls keine anderen Vereinbarungen getroffen wurden.

Ausland: Nach besonderen Vereinbarungen; maßgebend ist der Zahlungsvermerk auf dem jeweiligen Angebot, der Proforma-Rechnung bzw. der Rechnung. Beträge unter EUR 25,- netto sind grundsätzlich nicht skontoberechtigt. Wechsel werden nur nach vorheriger Vereinbarung hereingenommen. Die Kosten der Diskontierung und Einziehung trägt grundsätzlich der Besteller. Bei Zahlungsverzug oder Stundung belasten wir Zinsen in Höhe von 2 % über dem zu diesem Zeitpunkt gültigen Diskontsatz der Deutschen Bundesbank. Die Wertstellung eingegangener Schecks und Wechsel erfolgt zu dem Tag, an dem wir über den Gegenwert verfügen können. Sollten uns nach Vertragsabschluß Umstände bekannt werden, welche die Kreditwürdigkeit des Kunden beeinträchtigen, sind wir berechtigt, Vorauszahlung oder andere Sicherheitsleistungen zu verlangen. Eine Zurückhaltung der Zahlung wegen Minderungs-, Wandlungs-, oder eventueller anderer Gegenansprüche, sowie die Aufrechnung mit solchen ist nicht zulässig.

## 7. Lieferung und Versand

Wenn nicht anders vereinbart, liefern wir grundsätzlich ab Werk ausschließlich Verpackung und Versand der Ware auf Gefahr des Bestellers erfolgen. Versicherungen gegen Diebstahl, Transportschäden usw. erfolgen nur auf Wunsch und Kosten des Bestellers. Falls keine besondere Vorschrift gegeben wird, wählen wir den günstigsten Versandweg.

Waren, die zu einem vereinbarten Termin versandbereit gemeldet werden, müssen umgehend abgerufen werden, da wir andernfalls berechtigt sind, diese auf Kosten und Gefahr des Bestellers zu lagern und als geliefert zu berechnen. Für Verladungen setzen wir Netto - Mindestauftragswerte wie folgt voraus: Inland - EUR 100,- Ausland - EUR 500,-, sofern in unseren Verkaufsunterlagen kein anderweitiger Vermerk gemacht wird. Wir behalten uns vor, Aufträge unter dieser Grenze entweder bis zum Erreichen des Mindestauftragswertes zurückzustellen oder mit einer Bearbeitungsgebühr von EUR 10,- zu belasten.

## 8. Eigentumsvorbehalt

Die gelieferte Ware bleibt bis zur endgültigen Bezahlung ohne Rücksicht auf den Rechtsgrund unser Eigentum. Für den Fall der Bezahlung auf Scheck-Wechselbasis bleibt der Eigentumsvorbehalt bis zur Einlösung des Wechsels durch den Besteller bestehen.

Der Besteller ist, so lange er sich nicht in Verzug oder in Zahlungsschwierigkeiten befindet, zur Veräußerung der Ware im ordnungsgemäßen Geschäftsverkehr berechtigt. Veräußert der Besteller die in unserem Vorbehaltseigentum stehende Ware, werden die durch die Veräußerung entstehenden Forderungen schon jetzt an uns abgetreten, ohne daß es im Falle der Veräußerung einer ausdrücklichen Bestätigung bedarf. Er ist nicht berechtigt, die Vorbehaltsware zu verpfänden oder zur Sicherheit an Dritte zu übereignen.

Bis zur endgültigen und vollständigen Bezahlung der Ware steht uns das Recht zu, auch ohne Ausübung des Rücktritts und ohne Nachfristsetzung auf Kosten des Bestellers die einstweilige Herausgabe der Vorbehaltsware zu verlangen, die Räumlichkeiten des Bestellers zu betreten und die Ware nötigenfalls wieder an uns zu nehmen.

Wird eine Be- oder Verarbeitung bzw. untrennbare Vermischung der Vorbehaltsware mit anderen, nicht dem Lieferer gehörenden Gegenständen vorgenommen, so erwerben wir das Miteigentum an der neuen Sache im Verhältnis des Rechnungswertes der Vorbehaltsware zu den anderen verarbeiteten oder vermischten Gegenständen zum Zeitpunkt der Verarbeitung oder Vermischung. Wird die gelieferte Ware vom Besteller oder dessen Beauftragten verändert oder als Teil größerer Einheiten verwendet, so geht unser Eigentum anteilmäßig automatisch auf die veränderte Ware oder die entstandenen größeren Einheiten über. Der Besteller verwahrt das Eigentum oder Miteigentum für den Lieferer und ist verpflichtet, diese gegen Feuer, Diebstahl und Wasser zu versichern. Etwaige Entschädigungsansprüche, die aus Schäden vorgenannter Art gegen Versicherungsgesellschaften oder sonstige Ersatzverpflichtete zustehen, werden in Höhe unserer Forderungen an uns abgetreten. Pfändungen oder andere Beeinträchtigungen unseres Eigentums sind uns unverzüglich mitzuteilen. Ohne die bisher dargelegten Bedingungen einzuschränken, geht das Risiko für die gelieferte Ware vom Tage der Lieferung auf den Besteller über.

## 9. Lieferzeit, Liefermöglichkeit

Lieferfristenangaben sind annähernd und ohne Verbindlichkeit für uns. Verzugsespesen und Schadenersatzansprüche bei Lieferverzögerungen können gegen uns in keinem Falle geltend gemacht werden. Die Lieferzeit beginnt nach Klärung sämtlicher kaufmännischer und technischer Einzelheiten. Wir sind berechtigt, Teillieferungen durchzuführen.

## 10. Höhere Gewalt

Streik und Aussperrung, Katastrophen, Betriebsstörungen, Materialmängel, Verkehrsmängel oder andere Ereignisse höherer Gewalt, ganz gleich ob sie bei uns oder bei unseren Vorlieferanten eintreten, entbinden uns von allen Verpflichtungen.

## 11. Mängelrügen

Beanstandungen werden nur entgegengenommen, wenn sie schriftlich und umgehend, d. h. sofort nach Erhalt der Sendung, angezeigt werden. Ein Recht auf Wandlung oder Minderung steht dem Besteller nicht zu. Über den Warenwert hinausgehende Ansprüche können nicht gestellt werden. Transportschäden sind stets beim Frachtführer zu reklamieren.

## 12. Garantie, Gewährleistung

Alle HEYTEC-Werkzeuge werden in unseren Werken sorgfältig überprüft und unterliegen voll der Garantie.

Wir ersetzen jedes Werkzeug kostenlos, das Material- oder Fertigungsfehler aufweist. Eine weitere Haftung ist ausgeschlossen. Kostenloser Ersatz erfolgt nicht, wenn die Untersuchung in unserem Werk ergibt, daß das Werkzeug unsachgemäß behandelt worden ist oder ein natürlicher Verschleiß vorliegt.

## 13. Haftung

Schadenersatzansprüche aus Fehlen zugesicherter Eigenschaften, Verzug, Unmöglichkeit der Leistung, schuldhafter Verletzung vertraglicher Nebenpflichten, sowie aus Verschulden bei Vertragsabschluß und aus unerlaubter Handlung werden ausgeschlossen, es sei denn, sie beruhen auf Vorsatz oder grober Fahrlässigkeit unserer gesetzlichen oder sonstigen uns zuzurechnenden Vertreter.

## 14. Erfüllungsort und Gerichtsstand

Erfüllungsort der Lieferung und Zahlung ist Remscheid. Gerichtsstand ist Remscheid. Es gilt das Recht der Bundesrepublik Deutschland.

## 15. Export und Re-Export

HEYTEC-Ware darf nur mit unserer schriftlichen Genehmigung exportiert oder re-exportiert werden.

## Terms of sale, delivery and payment

### 1. Acceptance of terms of sale, delivery and payment

Our sales are based on the following terms and conditions whereby only the latest issue of our sales literature is valid.

Any variations to these and verbal arrangements require our confirmation in writing. Conditions of the buyer shall not be binding to us, also if not expressly objected by us. The placing of an order contract with us implies acceptance of our conditions. Validity of contract is only reached with our written order confirmation.

### 2. Quotations

Our offers are without obligation. Catalogue and pricelist form part of our offers. Weights and dimensions, illustrations, performance details, technical drawings and data are subject to change without prior notice, unless contracted and confirmed otherwise.

### 3. Copyright

All drawings, illustrations, photographs and other documents supplied by us to customers or third parties remain our property and are subject to copyright. They are not to be reproduced or made available to others without our written consent; they are to be stored in a safe place and must be returned to us on demand. Should production of merchandise to drawings, samples or other customer's specification involve an infringement of third party copyrights the customer indemnifies us from and against all claims.

### 4. Special manufacture

We reserve the right to modify the quantities ordered for special production by plus or minus 10 %, also normal production items, which are marked or finished to buyer's special requirements. Such orders cannot be cancelled once accepted by us. We are unable to accept the return of such items for credit or allowance.

If the customer becomes insolvent or bankrupt we reserve the right to sell this merchandise directly. For production to customer's documents the customer shall be solely responsible for the accuracy of drawings, samples, gauges etc. On principle samples are only supplied against invoice.

### 5. Prices

We reserve the right to adjust prices in case there should be changes in basic production costs, such as raw material, power, wages etc. up to date of delivery. Parts ordered will only be shipped in packing units identified in our sales literature. Smaller quantities or quantities, which are not divisible by packing units will be packed in paper only and levied with an increase of 25 % provided no other information has been given in our sales literature.

### 6. Terms of payment

Our invoices are payable Home market: 10 days after date of invoice less 2 % cash discount or 30 days after date of invoice net, provided no other arrangements have been agreed. Export markets: According to special arrangements, which are stated on our quotations, proforma invoices, order confirmations and/or invoices.

On principle invoice values below EUR 25,- net do not qualify for cash discount. Drafts will only be accepted after prior arrangements and all charges are to buyer's account. In the event of delayed payments or respites we shall charge interests at a rate of 2 % above the bank rate of the Deutsche Bundesbank being in force at the relevant time.

The credit values of cheques and drafts received are entered for that day, when their value is at our disposal. In case we should learn about circumstances restricting the creditworthiness of the customer after a contract has been concluded, we are permitted to ask for payment in advance or other satisfactory securities. Retention of payment due to claims of diminution, transformation or other eventual counterclaims as well as settling of accounts incorporating the above is not permissible.

### 7. Dispatch and delivery

Unless arranged and confirmed to the contrary delivery is effected ex works, packing excluded. Goods are delivered at buyer's risk. Insurance against theft, damages in transit etc. can be arranged on specific request and to customer's account. We reserve the right to choose the most economic method of transport unless particular instructions are given.

Goods, which have been packed to be ready for dispatch for an agreed date must be called off immediately, as otherwise we are entitled to store same at buyer's risk and cost and to invoice shipment as delivered.

For shipments our minimum net order values are - Home market EUR 100,- Export markets EUR 500,-, unless no other terms are quoted in our sales literature. Terms of Sale, Delivery and Payment. For orders with smaller values we reserve the right to postpone shipment until minimum order value is reached or to charge a handling fee amounting to EUR 10,00.

### 8. Title to the goods

Goods delivered remain our property until payment is received in full. It is expressly reserved that any law contradicting this clause shall not impair our rights concerning our goods. The buyer may dispose of the goods in the usual businesslike manner provided he is not insolvent or in default. Should the customer sell goods, which are still our property respective credit is due to our account automatically without express confirmation. The buyer is not entitled to distract or, as security to third parties, assign goods which are still our property.

Until paid for in full we are entitled to demand the release of goods and to enter buyer's premises with the object of re-taking possession of the goods. We are not obliged to execute withdrawal and to award postponement at customer's costs.

In case processing, further treatment or inseparable blending of provisogoods is effected with other merchandise or parts not belonging to us, we automatically gain partial ownership on the processed goods to such value as it is in relation to the processed or blended merchandise at the moment of processing or blending. Should supplied goods through buyer or on behalf of buyer be subjected to alterations or be used as part of larger units, then automatically partial ownership is transferred to the changed merchandise or the produced larger units. The buyer storing seller's property or partial property is obliged to secure same against fire, theft and water. Eventual claims for damages against insurance companies resulting from damages mentioned before are to be assigned to us representing the amount of our claim. Distrains and/or any other limitation, which might be imposed on our property despite the reservations outlined in the proceeding sentences must be reported immediately.

Notwithstanding the conditions outlined above, goods are at the entire risk of the buyer from the date of delivery.

### 9. Time of delivery and delays

All information given in respect of delivery period is approximate and without obligation. Liability in case of delay in delivery, interest for delay and/or damages cannot be accepted. The time of delivery begins only after clarification of all clerical and technical details. We are permitted to effect part shipments.

### 10. Force majeure

Force majeure, such as strike and lock-out, catastrophes of any kind, breakdown in supply of any kind, delivery of faulty material or other restrictions through force majeure shall release us from our liabilities, no matter if occurred with us or our sub-suppliers.

### 11. Claims

Claims must be made immediately on receipt of the goods and in writing, as otherwise such claims will not be accepted by us. Amendments to or deductions from invoices will not be accepted. The customer is not entitled to make claims above the nominal value of the goods involved. Damages in transit are to be claimed with the carrier.

### 12. Guarantee, warranty

All HEYTEC tools are carefully tested before leaving our works and are fully guaranteed. We shall replace free of charge any tool indicating faults of material and workmanship. Any further liability is excluded. Tools returned as faulty, which on inspection/test prove to have failed due to abuse, incorrect use or fair wear and tear are excluded from this guarantee and replacement will be charged.

### 13. Liability

Claims for compensation due to missing of promised features, delays, impossibility of performance, guilty violation of contractual secondary obligations, faults with conclusion of contract as well as unauthorized action are excluded save where our legal representatives are shown to have acted on purpose or negligently.

Liability even for careless violation is limited to compensation, which is foreseeable at the moment of conclusion of contract.

### 14. Settling place and place of competency

Remscheid is the settling place for delivery, payment and competency of justice in case of dispute. Only the law of the Federal Republic of Germany shall govern.

### 15. Export and re-export

Only with our written approval HEYTEC goods may be exported or re-exported.

### Abkürzungen, Symbole, Hinweise

Alle Katalogartikel werden technisch ständig optimiert; daher sind Änderungen jederzeit und ohne Ankündigung möglich. Unsere Katalogpreise sind Grundpreise ohne Mehrwertsteuer.

Sie sind bei Weiterverkauf durch den Handel als unverbindliche Preisempfehlung anzusehen und nicht zur Weitergabe bestimmt. Der Nachdruck dieses Kataloges oder Teilen daraus, die Vervielfältigung, Speicherung und Übermittlung jedweder Art, auch durch Datenverarbeitungsanlagen, sind nur mit unserer schriftlichen Genehmigung gestattet.

### Abbreviations, symbols, notes

All catalogue articles are continuously updated to the latest technical standards. As a result, specifications are subject to change without prior notice. Our catalogue prices are gross-prices, excluding value added tax. They are to be considered as recommended retail prices. Reprint of this catalogue or parts thereof, reproduction, storage in retrieval systems, unauthorized utilization and transmission in any form or by any means including computer systems is only permitted with our prior consent in writing.

### Afkortingen, symbolen, verwijzingen

Alle artikelen in deze catalogus worden in technisch opzicht voortdurend verbeterd; daarom zijn wijzigingen te allen tijde en zonder aanzegging mogelijk.









































Nadruk van deze catalogus of delen ervan, vermenigvuldiging, opslag en overdracht van welke aard dan ook, ook door gegevensverwerkende installaties, zijn alleen toegestaan met onze schriftelijke toestemming.

























































### Abréviations, symboles, indications

Les produits du catalogue étant soumis à des améliorations techniques permanentes, le fabricant se réserve le droit de modifier leurs caractéristiques à tout moment et sans préavis. Les prix indiqués dans ce catalogue sont des prix de base hors T.V.A. Ils sont donnés à titre indicatif aux revendeurs et ne sont pas destinés à être divulgués. Toute reproduction, copie ou diffusion totale ou partielle que ce soit, notamment par photocopie ou par équipement informatique, est interdite sans notre autorisation écrite.

### Abreviaturas, símbolos, información

Todos los artículos del catálogo están sometidos a perfeccionamiento continuo. Por eso, están sujetos a posibles modificaciones sin previo aviso. Observen que los datos contenidos en las tablas están solamente en alemán e inglés. Para condiciones de venta, envío y pago, índice alfabético véanse catálogos en vigor. El presente catálogo – tarifa refleja precios de venta al público recomendados, por pieza/juego, I.V.A. no incluido. La reproducción íntegra o parcial de este catálogo, su copia, registro o retransmisión de cualquier tipo, incluso por medios informáticos, requieren obligatoriamente nuestra autorización escrita.



 Packeinheit	 packing unit
 Länge	 length
 Durchmesser	 diameter
 metrische Schlüsselweiten für Schrauben und Muttern mit Außensechskant	 spanner openings in metric for hexagon head screws, bolts and nuts
 metrische Schlüsselweiten für Innensechskantschrauben	 sizes in metric for hexagon socket screws and bolts
 Schlüsselweite bei TORX®-Schrauben	 size in millimetres for TORX®-screws
 Innensechskant Schon-Profil	 inside hexagon (profile saver)
 Innen-Doppelsechskant Schon-Profil	 inside bihexagon (profile saver)
 für Außen-TORX®-Schrauben	 for TORX®-head screws
 Innenvierkant	 inside square
 Außenvierkant	 outside square
 Außensechskant u. für Innensechskantschrauben	 outside hexagon – for hexagon socket screws
 für Schlitzschrauben	 for plain slot screws
 für Kreuzschlitzschrauben PHILLIPS-RECESS	 for cross slot screws PHILLIPS-RECESS
 für Kreuzschlitzschrauben POZIDRIV®	 for cross slot screws POZIDRIV®
 für Innen-Keilprofil-Schrauben RIBE CV	 for fluted socket screws RIBE CV
 für Innenvielzahn-Schrauben XZN	 for multi-spline socket screws XZN
 für Innen-TAMPER-TORX®-Schrauben	 for TAMPER-TORX®-socket screws
 für Innen-TORX®-Schrauben POZIDRIV® eingetragenes Warenzeichen der Firma European Industrial Services Ltd.	 for TORX®-socket screws POZIDRIV® Registered trade mark of European Industrial Services Ltd.
 eingetragenes Warenzeichen der Firma CAMCAR/TEXTRON INC.	 Registered trade mark of CAMCAR/TEXTRON INC.

 verpakkingseenheid	 unité d'emballage	 unidad de envase
 lengte	 longueur	 longitud
 diameter	 diamètre	 diámetro
 metrische sleutelwijdte voor bouten en moeren met buitenzeskant	 ouvertures métriques pour vis et écrous hexagonaux	 medidas métricas para tornillos y tuercas con hexágono exterior
 metrische sleutelwijdte voor binnenzeskant-bouten	 ouvertures métriques pour vis 6 pans creux	 medidas métricas para tornillos con hexágono interior
 sleutelwijdte bij TORX®-bouten	 ouvertures métriques pour vis TORX®	 medidas para tornillos TORX®
 Innensechskant Schon-Profil	 6 pans intérieur – profil d'usure	 hexágono interior, perfil protector
 binnenzeskant	 12 pans intérieur – profil d'usure	 estrella interior, perfil protector
 voor buiten-TORX®-schroeven	 pour vis TORX® extérieures	 para tornillos TORX® exteriores
 binnenvierkant	 carré femelle	 cuadrado interior
 buitenvierkant	 carré mâle	 cuadrado exterior
 buitenzeskant	 6 pans mâle	 hexágono exterior
 voor sleufschroeven	 pour vis à fente	 para tornillos ranurados
 voor kruiskopschroeven PHILLIPS-RECESS	 pour vis cruciformes PHILLIPS-RECESS	 para tornillos PHILLIPS-RECESS
 voor kruiskopschroeven POZIDRIV®	 pour vis cruciformes POZIDRIV®	 para tornillos POZIDRIV®
 voor spiebaanbouten RIBE CV	 pour vis à empreinte à créneaux RIBE CV	 para tornillos RIBE CV
 voor binnenvleelbandbouten XZN	 pour vis denture multiple XZN	 para tornillos XZN
 voor binnen-TAMPER-TORX®-schroeven	 pour vis TAMPER-TORX® intérieures	 para tornillos TAMPER-TORX® interiores
 voor binnen-TORX®-schroeven	 pour vis TORX® intérieures	 para tornillos TORX® interiores
POZIDRIV® gedeponerd handelsmerk van de firma European Industrial Services Ltd.	POZIDRIV® marque déposée par la société European Industrial Services Ltd.	POZIDRIV® marca registrada de European Industrial Services Ltd.
TORX® gedeponerd handelsmerk van de firma CAMCAR/TEXTRON INC.	TORX® marque déposée par la société CAMCAR/TEXTRON INC.	TORX® marca registrada de CAMCAR/TEXTRON INC.



HEYCO Qualitätswerkzeuge  
GmbH & Co. KG  
Birgden III/1  
42855 Remscheid  
Germany

Tel. +49 (0) 2191 205-0  
Fax +49 (0) 2191 205-266  
info@heyco.de  
heyco-qualitaetswerkzeuge.de

  Folgen Sie uns  
@heyco\_qualitaetswerkzeuge



Code 50895082200